

Configurable logical module

Code: EK-LM2-TP



Datasheet STEKLM2TP_EN

Configurable KNX bus device to perform logic and data processing functions on data. It has to be used in KNX installations for control of homes and buildings.

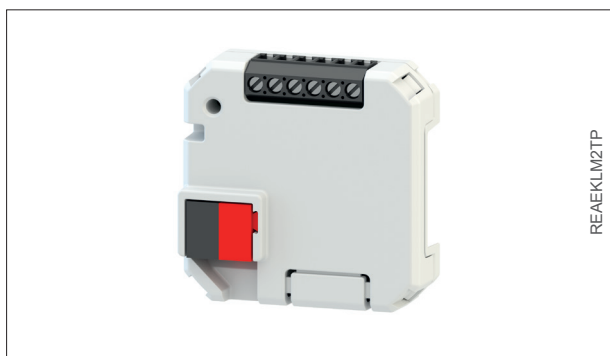

Description

The configurable logical module ekinex® EK-LM2-TP is a KNX S-mode device that can be used to perform logic and data processing functions on data exchanged on the KNX bus.

The device is suitable for mounting in wall box or on 35 mm rail (EN 60715) with the support EK-SMG-35 included in the delivery.

To be used in KNX installations for home and building automation. The device is powered by the KNX bus line with a SELV voltage 30 Vdc and does not require auxiliary power.

Functionalities

The device implements independent blocks of the below listed types:

- Logic: Combines a number of boolean inputs according to logic operations.
- Arithmetic / Math: Performs mathematical computations on one or more input values.
- Range: Performs a scaling of the input value to a different range of values, or a boundary limit.
- Mapping: Translates a set of input values (up to 8 points) to a different set of output values. Conversion: Converts a KNX communication object to another one with a different KNX data type (DPT).
- Timer: Implements a one-shot (monostable) or free-running (astable) timer, with configurable on- and off-delay times.
- Compare: Returns the result of a comparison (equal, larger, smaller etc.) between two input values.

- Multiplexer: Copies the value of one input object to either 1 of N output objects, or to all objects selected in the output set.

Each function can be configured in different ways by means of parameters in the ETS application.

There are several independent instances available for each type of block, therefore the device can be used to fulfill many requirements or to solve a large number of contingencies in the same installation.

An additional terminal block allows the connection of up to 4 dry contacts for simple external inputs.

Main characteristics

- Housing in plastic material
- Wall installation in flush mounting box or, with a mounting support, on 35 mm rail (according to EN 60715)
- Protection degree IP20 (installed device)
- Classification climatic 3K5 and mechanical 3M2 (according to EN 50491-2)
- Pollution degree 2 (according to IEC 60664-1)
- Weight 20 g
- Dimensions 43 x 43 x 16 mm (WxHxD)

Technical data

- Power supply 30 Vdc from KNX bus line
- Current consumption < 10 mA

Environmental conditions

- Operating temperature: - 5 ... + 45°C
- Storage temperature: - 25 ... + 55°C
- Transport temperature: - 25 ... + 70°C
- Relative humidity: 95% not condensing

Accessories

Rail-mounting support

The device can be mounted on 35 mm rail (according to EN 60715) with the support EK-SMG-35 included in the delivery.

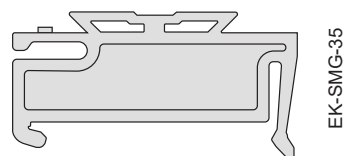

Spring for hooking on wall-mounting devices

The device can be hooked on the back of some ekinex® wall-mounting devices with the spring EK-MAR to be ordered separately (preventively check the compatibility).

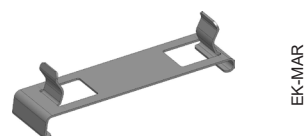

Switching, display and connection elements

The device is equipped with a programming LED and a programming pushbutton, a terminal block for connection of the KNX bus line and a terminal block for connection of external inputs.

Switching and display elements

- Pushbutton (3) for switching between the normal and programming operating modes
- Red LED (2) for indication of the active operating mode (on = programming, off = normal operation)

Connection elements

- KNX bus terminal block (1)
- 6-pole screw terminal block (4) for connection of external inputs, current transformers

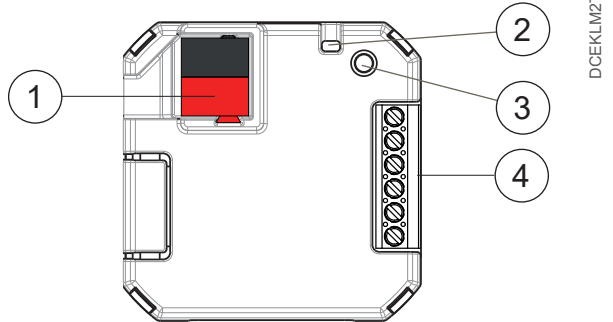

- 1) Terminal block for KNX bus line
- 2) Programming LED
- 3) Programming pushbutton
- 4) 6-pole terminal block for connection of up to 4 dry contacts for simple external inputs.

Connection of the KNX bus line

The connection of the bus line is made with the KNX terminal block (1) included in delivery and inserted into the slot of the housing.

Characteristics of the KNX terminal block

- Spring clamping of conductors
- 4 seats for conductors for each polarity
- Terminal suitable for KNX bus cable with single-wire conductors and diameter between 0.6 and 0.8 mm
- Recommended wire stripping approx. 5 mm
- Color codification: red = + (positive) bus conductor, black = - (negative) bus conductor

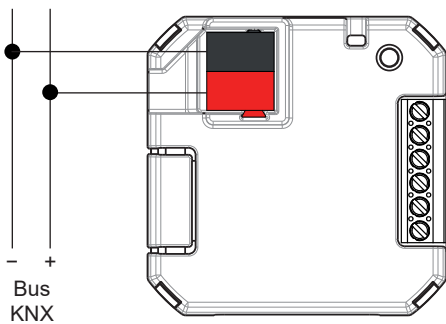

Warning! In order to supply the KNX bus lines use only KNX bus power supplies (e.g. ekinex EK-AB1-TP or EK-AG1-TP). The use of other power supplies can compromise the communication and damage the devices connected to the bus.

Connection of inputs

The connection of the inputs is made with the screw terminal block (4) inserted into the slot of the housing.

Characteristics of the terminals

- Screw clamping of conductors
- Maximum cross section of conductor 1 mm²

- Recommended wire stripping approx. 5 mm
- Torque max 0.2 Nm

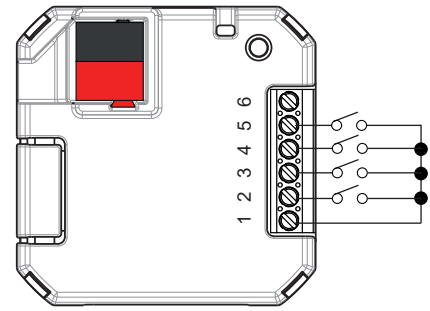

Connection of free-potential contacts

Input	Mark	Connection
1	COM	Input common
2	IN1	Input 1
3	IN2	Input 2
4	IN3	Input 3
5	IN4	Input 4



Warning! The electrical connection of the device can be carried out only by qualified personnel. The incorrect installation may result in electric shock or fire. Before making the electrical connections, make sure the power supply has been turned off.

Mounting

The device has degree of protection IP20, and is therefore suitable for use in dry interior rooms. The support EK-SMG-35 allows the mounting on 35 mm rail in boards or cabinets for electrical distribution.

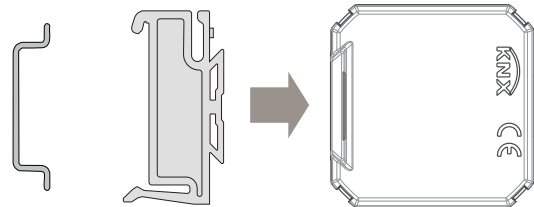

a) Insert the mounting support into the appropriate shaped profile of the interface

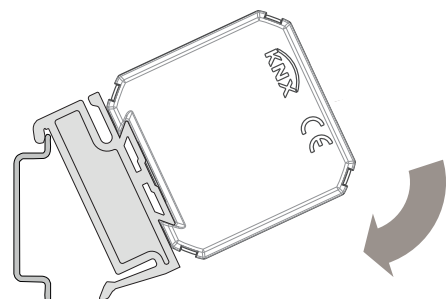

b) Place the support clamping tooth on the top edge of the mounting rail and rotate device and support towards the guide until it completely engages

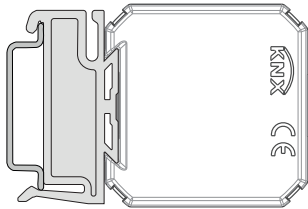

c) Once fastened, connect the bus line and the external inputs

Configuration and commissioning

Configuration and commissioning of the device require the use of the ETS® (Engineering Tool Software) program V4 2.0 or later releases. These activities must be carried out according to the design of the building automation system done by a qualified planner.



Note. The configuration and commissioning of KNX devices require specialized skills. To acquire these skills, you should attend the workshops at KNX certified training centers.

Configuration

For the configuration of the device parameters the corresponding application program or the whole ekinex® product database must be loaded in the ETS program. For detailed information on configuration options, refer to the application manual of the device available on the website www.ekinex.com.

Product code	Application software (## = release)	Comm. objects (max nr.)	Group addresses (max nr.)
EK-LM2-TP	APEKLM2TP##.knxprod	414	254

Commissioning

For commissioning the device the following activities are required:

- make the electrical connections as described above;
- turn on the bus power supply;
- switch the device operation to the programming mode by pressing the programming pushbutton located on the front side of the housing. In this mode of operation, the programming LED is turned on;
- download into the device the physical address and the configuration with the ETS® program.

At the end of the download the operation of the device automatically returns to normal mode; in this mode the programming LED is turned off. Now the bus device is programmed and ready for use.

Reset of the device

To reset the device remove the bus connection by extracting the bus terminal from its seat. Keeping pressed the programming pushbutton, reinsert the bus terminal in his seat; the programming LED blinks fast. Release the programming button and remove the bus terminal again; the reset was carried out. Now you need to address and configure again the device via ETS.



Warning! The reset restores the device back to the state of delivery from the factory. The address and the value of the parameters set during configuration will be lost.

Dimensions [mm]

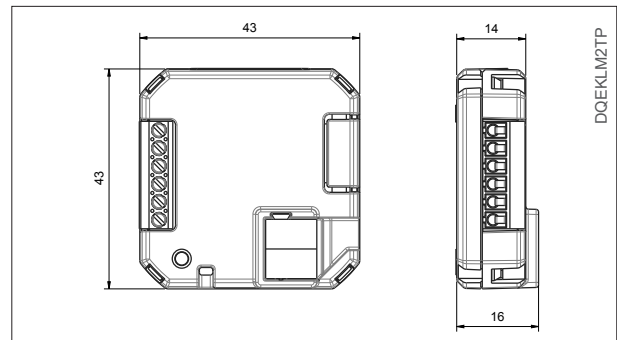

Marks

- KNX
- CE: the device complies with the Low Voltage Directive (2014/35/EU) and the Electromagnetic Compatibility Directive (2014/30/EU). Tests carried out according to EN 50491-5-1:2010 and EN 50491-5-2:2010

Maintenance

The device is maintenance-free. To clean use a dry cloth. It must be avoided the use of solvents or other aggressive substances.

Disposal



At the end of its useful life the product described in this datasheet is classified as waste from electronic equipment in accordance with the European Directive 2012/19/EU (WEEE recast), and cannot be disposed together with the municipal undifferentiated solid waste.



Warning! Incorrect disposal of this product may cause serious damage to the environment and human health. Please be informed about the correct disposal procedures for waste collecting and processing provided by local authorities.

Document

This datasheet refers to the release 01 of the ekinex® device EK-LM2-TP, and is available for download at www.ekinex.com as a PDF (Portable Data Format) file.

Warnings

- Installation, electrical connection, configuration and commissioning of the device can only be carried out by qualified personnel in compliance with the applicable technical standards and laws of the respective countries
- The use of the device in safety applications is not allowed. The device may however be used for auxiliary signaling functions
- Opening the housing of the device causes the immediate end of the warranty period
- In case of tampering, the compliance with the essential requirements of the applicable directives, for which the device has been certified, is no longer guaranteed
- ekinex® KNX defective devices must be returned to the manufacturer at the following address: EKINEX S.p.A Via Novara 37, I-28010 Vaprio d'Agogna (NO) Italy

Other information

- The instruction sheet must be delivered to the end customer with the project documentation
- For further information on the product, please contact the ekinex® technical support at the e-mail address: support@ekinex.com or visit the website www.ekinex.com
- Each ekinex® device has a unique serial number on the label. The serial number can be used by installers or system integrators for documentation purposes and has to be added in each communication addressed to the EKINEX technical support in case of malfunctioning of the device
- KNX® and ETS® are registered trademarks of KNX Association cvba, Brussels

© EKINEX S.p.A. The company reserves the right to make changes to this documentation without notice.