

## CC-Link IE Field Network Adapter

**GN-9285**

## User Manual



Version 1.00

**2020 CREVIS Co.,Ltd**

DOCUMENT CHANGE SUMMARY				
REV	PAGE	REMARKS	DATE	EDITOR
1.00	New Document		2020/7/31	CH Hong

## CONTENTS

<a href="#">1. Important Notes</a>	<a href="#">5</a>
<a href="#">1.1. Safety Instruction</a>	<a href="#">6</a>
<a href="#">1.1.1. Symbols</a>	<a href="#">6</a>
<a href="#">1.1.2. Safety Notes</a>	<a href="#">6</a>
<a href="#">1.1.3. Certification</a>	<a href="#">6</a>
<a href="#">2. Specification</a>	<a href="#">7</a>
<a href="#">2.1. The Interface</a>	<a href="#">7</a>
<a href="#">2.1.1. GN-9285</a>	<a href="#">7</a>
<a href="#">2.2. Specification</a>	<a href="#">8</a>
<a href="#">2.2.1. General Specification</a>	<a href="#">8</a>
<a href="#">2.2.2. Input Specification</a>	<a href="#">9</a>
<a href="#">2.3. LED Indicator</a>	<a href="#">11</a>
<a href="#">2.3.1. MOD (Module Status LED)</a>	<a href="#">11</a>
<a href="#">2.3.2. NET (Network status LED)</a>	<a href="#">11</a>
<a href="#">2.3.3. ERROR (Error status LED)</a>	<a href="#">11</a>
<a href="#">2.3.4. IOS LED (G-Bus Status LED)</a>	<a href="#">11</a>
<a href="#">2.3.5. Field Power LED</a>	<a href="#">12</a>
<a href="#">2.3.6. Indicator Status and Flash Rates</a>	<a href="#">12</a>
<a href="#">3. Dimension</a>	<a href="#">13</a>
<a href="#">3.1. GN-9285</a>	<a href="#">13</a>
<a href="#">4. Mechanical Set Up</a>	<a href="#">14</a>
<a href="#">4.1. Total Expansion</a>	<a href="#">14</a>
<a href="#">4.2. Plugging and Removal of the Components</a>	<a href="#">14</a>
<a href="#">4.3. Internal FnBus/Field Power Contacts</a>	<a href="#">15</a>
<a href="#">5. CC-Link Electrical Interface</a>	<a href="#">16</a>
<a href="#">5.1. G-Bus System</a>	<a href="#">16</a>
<a href="#">6. GN-9285 Communication Interface</a>	<a href="#">18</a>
<a href="#">6.1. RJ-45 Socket</a>	<a href="#">18</a>
<a href="#">6.2. Dip Switch</a>	<a href="#">18</a>
<a href="#">7. MODBUS Interface</a>	<a href="#">19</a>
<a href="#">7.1. MODBUS Interface Register/Bit Map</a>	<a href="#">19</a>
<a href="#">7.2. Supported MODBUS Function Codes</a>	<a href="#">20</a>
<a href="#">7.3. MODBUS Special Register Map</a>	<a href="#">24</a>
<a href="#">7.4. MODBUS Reference</a>	<a href="#">27</a>
<a href="#">8. Trouble Shooting</a>	<a href="#">28</a>
<a href="#">8.1. How to diagnose by LED indicator</a>	<a href="#">28</a>
<a href="#">APPENDIX A</a>	<a href="#">29</a>

[A.1. Product List.....](#) [29](#)

[A.2. Glossary.....](#) [31](#)

## 1. Important Notes

Solid state equipment has operational characteristics differing from those of electromechanical equipment. Safety Guidelines for the Application, Installation and Maintenance of Solid State Controls describes some important differences between solid state equipment and hard-wired electromechanical devices. Because of this difference, and also because of the wide variety of uses for solid state equipment, all persons responsible for applying this equipment must satisfy themselves that each intended application of this equipment is acceptable.

In no event will CREVIS be responsible or liable for indirect or consequential damages resulting from the use or application of this equipment.

The examples and diagrams in this manual are included solely for illustrative purposes. Because of the many variables and requirements associated with any particular installation, CREVIS cannot assume responsibility or liability for actual use based on the examples and diagrams.

### Warning!

**If you don't follow the directions, it could cause a personal injury, damage to the equipment or explosion**

Do not assemble the products and wire with power applied to the system. Else it may cause an electric arc, which can result into unexpected and potentially dangerous action by field devices. Arching is explosion risk in hazardous locations. Be sure that the area is non-hazardous or remove system power appropriately before assembling or wiring the modules.

Do not touch any terminal blocks or IO modules when system is running. Else it may cause the unit to an electric shock or malfunction.

Keep away from the strange metallic materials not related to the unit and wiring works should be controlled by the electric expert engineer. Else it may cause the unit to a fire, electric shock or malfunction.

### Caution!

**If you disobey the instructions, there may be possibility of personal injury, damage to equipment or explosion. Please follow below Instructions.**

Check the rated voltage and terminal array before wiring. Avoid the circumstances over 50°C of temperature. Avoid placing it directly in the sunlight.

Avoid the place under circumstances over 85% of humidity.

Do not place Modules near by the inflammable material. Else it may cause a fire.



Do not permit any vibration approaching it directly.

Go through module specification carefully, ensure inputs, output connections are made with the specifications. Use standard cables for wiring.

Use Product under pollution degree 2 environment.

## 1.1. Safety Instruction

### 1.1.1. Symbols

<p><b>DANGER</b></p> 	<p>Identifies information about practices or circumstances that can cause an explosion in a hazardous environment, which may lead to personal injury or death property damage or economic loss.</p>
<p><b>IMPORTANT</b></p>	<p>Identifies information that is critical for successful application and understanding of the product.</p>
<p><b>ATTENTION</b></p> 	<p>Identifies information about practices or circumstances that can lead to personal injury, property damage, or economic loss. Attentions help you to identify a hazard, avoid a hazard, and recognize the consequences.</p>

### 1.1.2. Safety Notes

<p><b>DANGER</b></p> 	<p>The modules are equipped with electronic components that may be destroyed by electrostatic discharge. When handling the modules, ensure that the environment (persons, workplace and packing) is well grounded. Avoid touching conductive components, e.g. FnBUS Pin.</p>
--	--

### 1.1.3. Certification

c-UL-us UL Listed Industrial Control Equipment, certified for U.S. and Canada  
See UL File E235505

CE Certificate  
EN 61000-6-2; Industrial Immunity  
EN 61000-6-4; Industrial Emissions

## 2. Specification

### 2.1. The Interface

#### 2.1.1. GN-9285

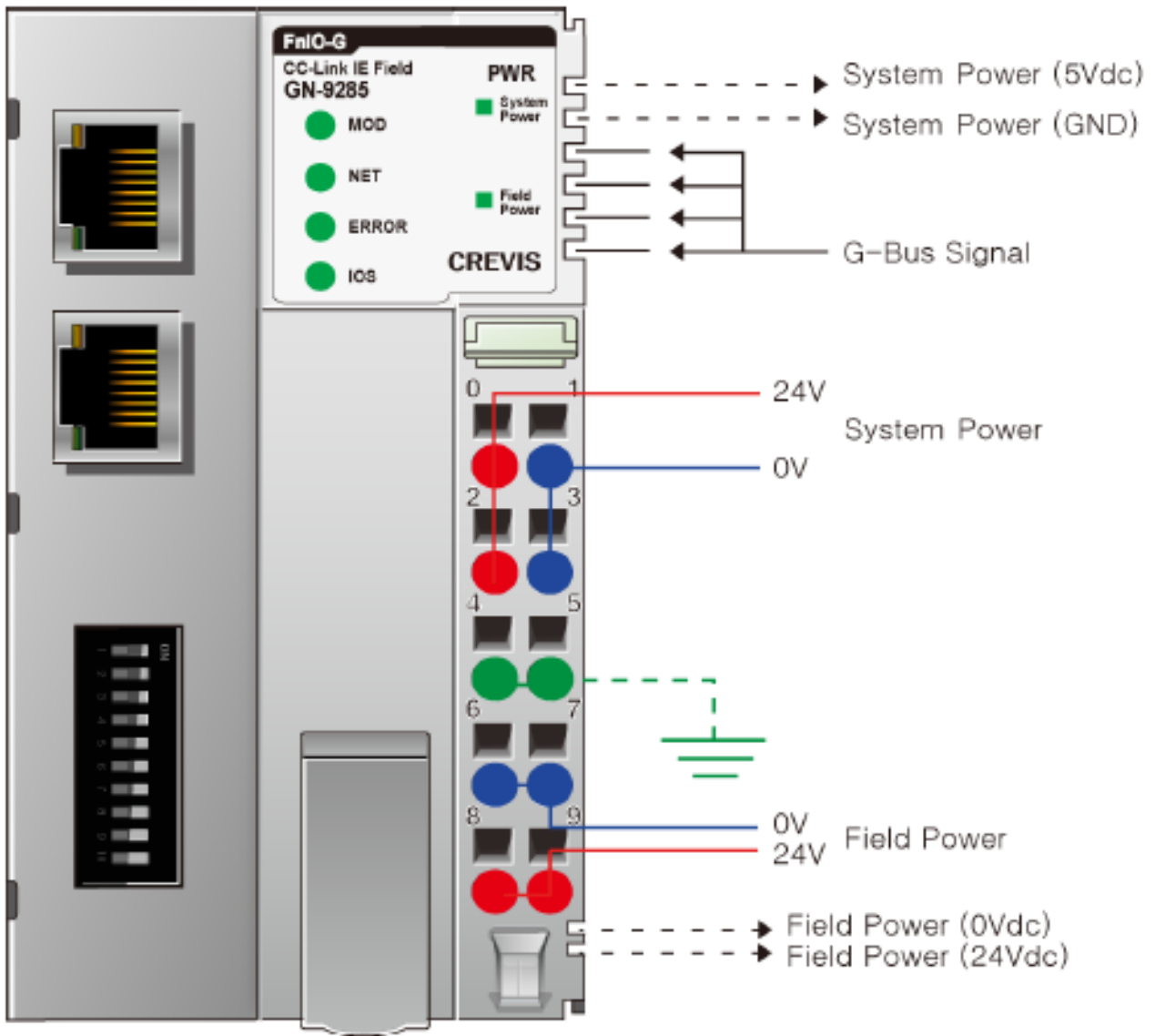

## 2.2. Specification

### 2.2.1. General Specification

<b>Environmental specification</b>	
Operating Temperature	60°C ~ 70°C : Power dissipation is limited to 0.8A. -40°C ~ 60°C : 1.5A full load is allowed.
UL Temperature	-20°C~60°C
Storage Temperature	-40°C~85°C
Relative Humidity	5% ~ 90% non-condensing
Mounting	DIN rail
<b>General specification</b>	
Shock Operating	IEC 60068-2-27
Vibration Resistance	Based on IEC 60068-2-6 DNVGL-CG-0039 : Vibration Class B, 4g
Industrial Emissions	EN 61000-6-4/A11 : 2011
Industrial Immunity	EN 61000-6-2 : 2005
Installation Position	Vertical and horizontal installation is available.
Product Certifications	CE, UL, FCC



## 2.2.2. Input Specification

Items	Specification
<b>Communication Specification</b>	
Adapter Type	Slave node (CC-Link IE Field Network)
Max. Expansion Module	63slots
Max. Data Size(Input + Output)	Max 128 bytes each slot
Max. Nodes number	120
Interface Connector	RJ-45 socket * 2pcs 8P8C Connector
Other Serial Port	RS232 for MODBUS/RTU, Touch Pannel or IOGuide
Serial Configuration (RS232)	Node : 1 (Fixed) Baud Rate : 115200 (Fixed) Data bit : 8 (Fixed) Parity bit : No parity (Fixed) Stop bit : 1 (Fixed)
Indicator	5 LED 1 Green/Red, Module Status (MOD) 1 Green, Current Running Status (NET) 1 Green, Error Status (ERROR) 1 Green/Red Expansion I/O Module Status (IOS) 1 Green, Field Power Status 2 LED (each RJ45 Connector) 1 Green, Active 1 Yellow, Link
Module Location	Starter module left side of G-bus system
Field Power Detection	About 14Vdc
Ethernet Standard	IEEE 802.3ab(1000Base-T)
Cable	Shield copper Cable(Cat.5e)
Network Topology	Star / Line / Ring / Mixture of star and Line
Station class	Intelligent Device station
RX / RY Size	256Bytes
RWW / RWR Size	1024Bytes
<b>General specification</b>	
UL System Power	Supply voltage : 24Vdc nominal, Class 2
System Power	Supply voltage : 24Vdc nominal Supply voltage range : 15~30Vdc Protection : Output current limit (Min. 1.5A) Reverse polarity protection
Power Dissipation	140mA typical @ 24Vdc
Current for I/O Module	1.5A @ 5Vdc(When using in '60°C ~ 70 °C' temperature environment, the power dissipation is limited to 0.8A.)
Isolation	System power to internal logic : Non-isolation System power I/O driver : Isolation
UL Field Power	Supply voltage : 24Vdc nominal, Class 2
Field Power	Supply voltage : 24Vdc nominal(Max. 30Vdc) * Field Power Range is different depending on IO Module series. Refer to IO Module's Specification.
Max. Current Field Power Contact	DC 10A Max
Wiring	I/O Cable Max. 2.0mm <sup>2</sup> (AWG 14)
Torque	0.8Nm(7 lb-in)

---

Weight	<165g
Module Size	54mm x 99mm x 70mm
<b>Environment Condition</b>	<b>Refer to '1. Environment Specification'</b>

## 2.3. LED Indicator

### 2.3.1. MOD (Module Status LED)

Status	LED is	To indicate
Not Powered	OFF	Not power is supplied to the unit.
Normal, Operational	Green	The unit is operating in normal condition.
Device in Standby	RED	The EEPROM parameter is not initialized yet. Serial Number is zero value (0x00000000)
Firmware upgrade	Flashing Green	Firmware upgrade. Boot mode

### 2.3.2. NET (Network Status LED)

Status	LED is	To indicate
Init / No Communication	Red	No Communication / Communication Disconnection
Communication	Green	Normal Communication
Communication Error	OFF	Communication Error / Token passing

### 2.3.3. ERROR (Error status LED)

Status	LED is	To indicate
No Error	OFF	
Invalid Configuration	Flashing Red	TBD

### 2.3.4. IOS LED (G-Bus Status LED)

Status	LED is	To indicate
Not Powered No Expansion Module	OFF	Device has no expansion module or may not be powered.
Do not have I/O	Flashing Red	Fn-bus is normal but does not exchanging I/O data. (Passed the expansion module configuration)
Internal bus Connection, Run Exchanging I/O	Green	Exchanging I/O data.
Expansion Configuration Failed	Red	One or more expansion module occurred in fault state. <ul style="list-style-type: none"> <li>- Detected invalid expansion module ID.</li> <li>- Too many expansion module</li> <li>- Initialization failure</li> <li>- Overflowed Input/Output Size</li> <li>- Communication failure.</li> <li>- Changed expansion module configuration.</li> <li>- Mismatch vendor code between adapter and expansion module.</li> </ul>

### 2.3.5. Field Power LED (Field Power, LED)

Status	LED is	To indicate
Not supplied field power	OFF	Not supplied 24Vdc field power, 5Vdc system power.
Supplied field power	Green	Supplied 24Vdc field power, 5Vdc system power.

### 2.3.6. Indicator Status and Flash Rates

LED ON	Constantly ON
LED OFF	Constantly OFF.
LED flickering	Equal ON and OFF times with a frequency of approximately 10 Hz: ON for approximately 50ms and OFF for approximately 50ms.
LED blinking	Equal ON and OFF times with a frequency of approximately 2, 5Hz: ON for approximately 200ms followed by OFF for approximately 200ms.
LED single flash	One short flash (approximately 200ms) followed by a long OFF phase (approximately 1000ms)
LED double flash	A sequence of two short flashes (approximately 200ms), separated by an OFF phase (approximately 200ms). The sequence is finished by a long OFF phase (approximately 1000ms)
LED triple flash	A sequence of three short flashes (approximately 200ms), separated by an OFF phase (approximately 200ms). The sequence is finished by a long OFF phase (approximately 1000ms)

### 3. Dimension

#### 3.1. GN-9285

(mm)

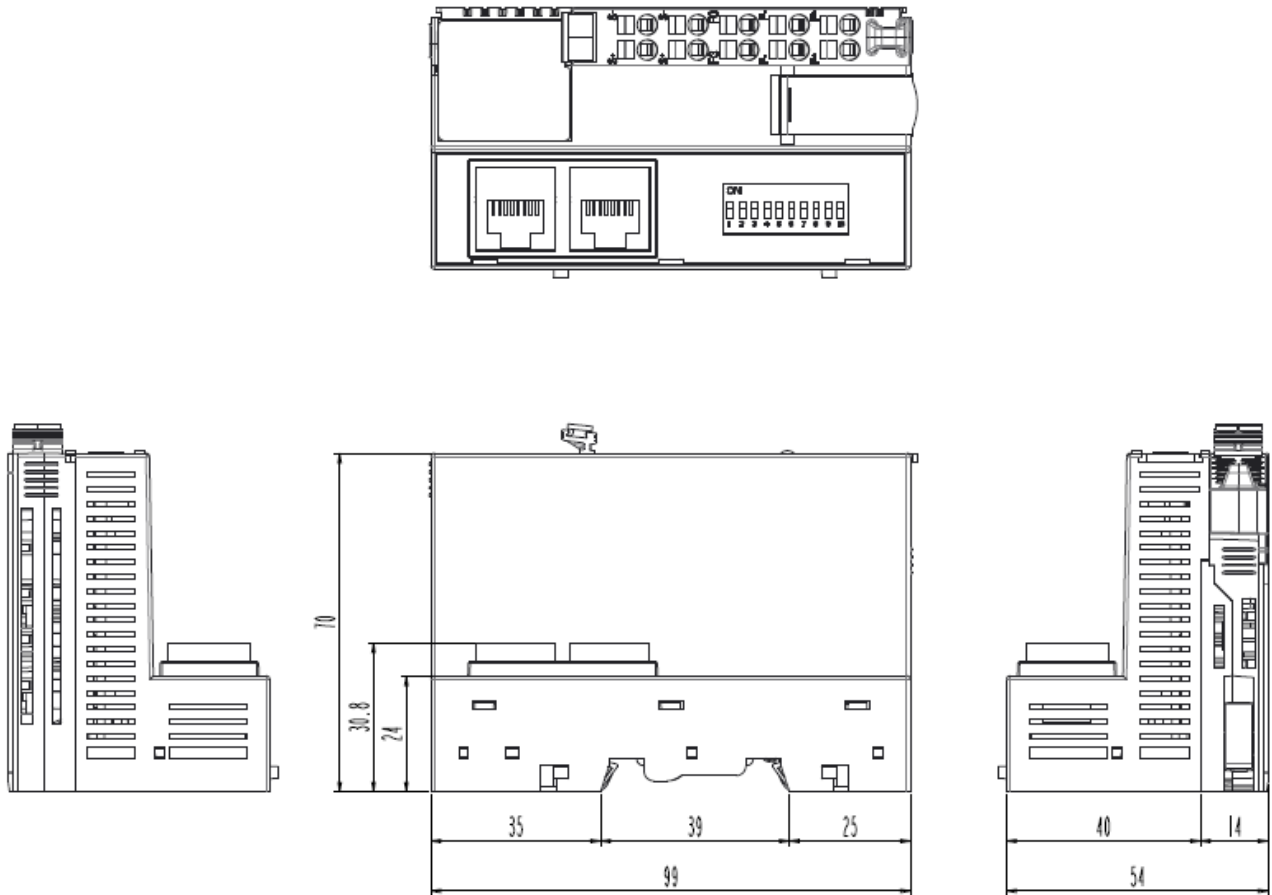

## 4. Mechanical Set Up

### 4.1. Total Expansion

The number of the module assembly that can be connected is 63.

### 4.2. Plugging and Removal of the Components.

<p>DANGER</p> 	<p>Before work is done on the components, the voltage supply must be turned off.</p>
---	--





As above figure in order to safeguard the FnIO module from jamming, it should be fixed onto the DIN rail with locking level. To do so, fold on the upper of the locking lever.

To pull out the FnIO module, unfold the locking lever as below figure.

### 4.3. Internal FnBus/Field Power Contacts

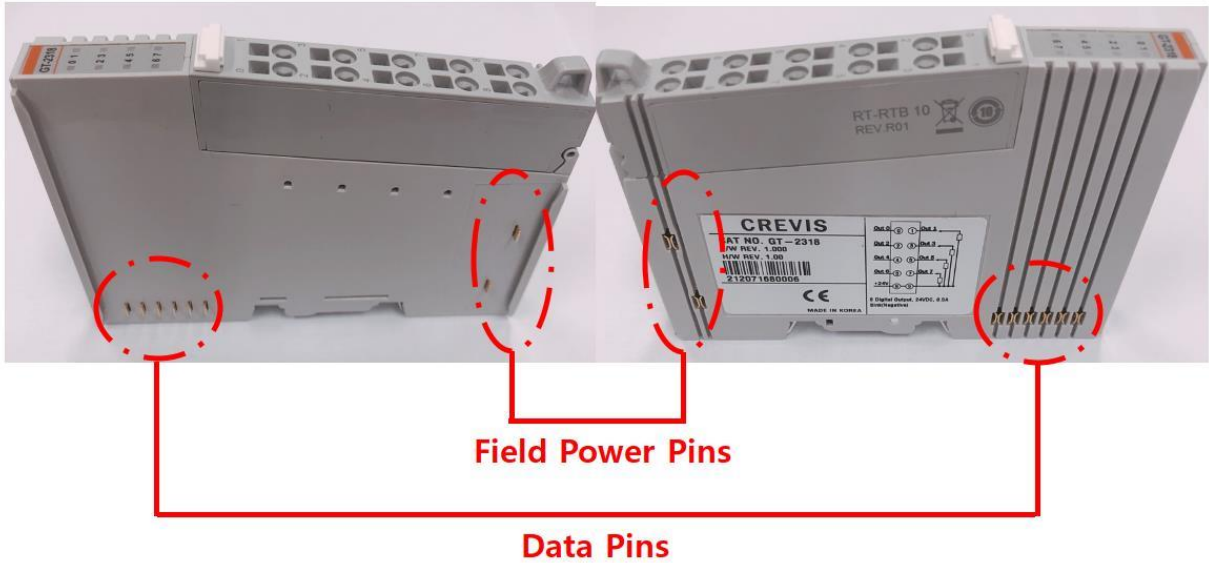
Communication between the NA series and the expansion module as well as system / field power supply of the bus modules is carried out via the internal bus. It is comprised of 6 data pin and 2 field power pin.



<p><b>DANGER</b></p> 	<p>Do not touch data and field power pins in order to avoid soiling and damage by ESD noise.</p>
--	--

## 5. CC-Link Electrical Interface

### 5.1. G-Bus System

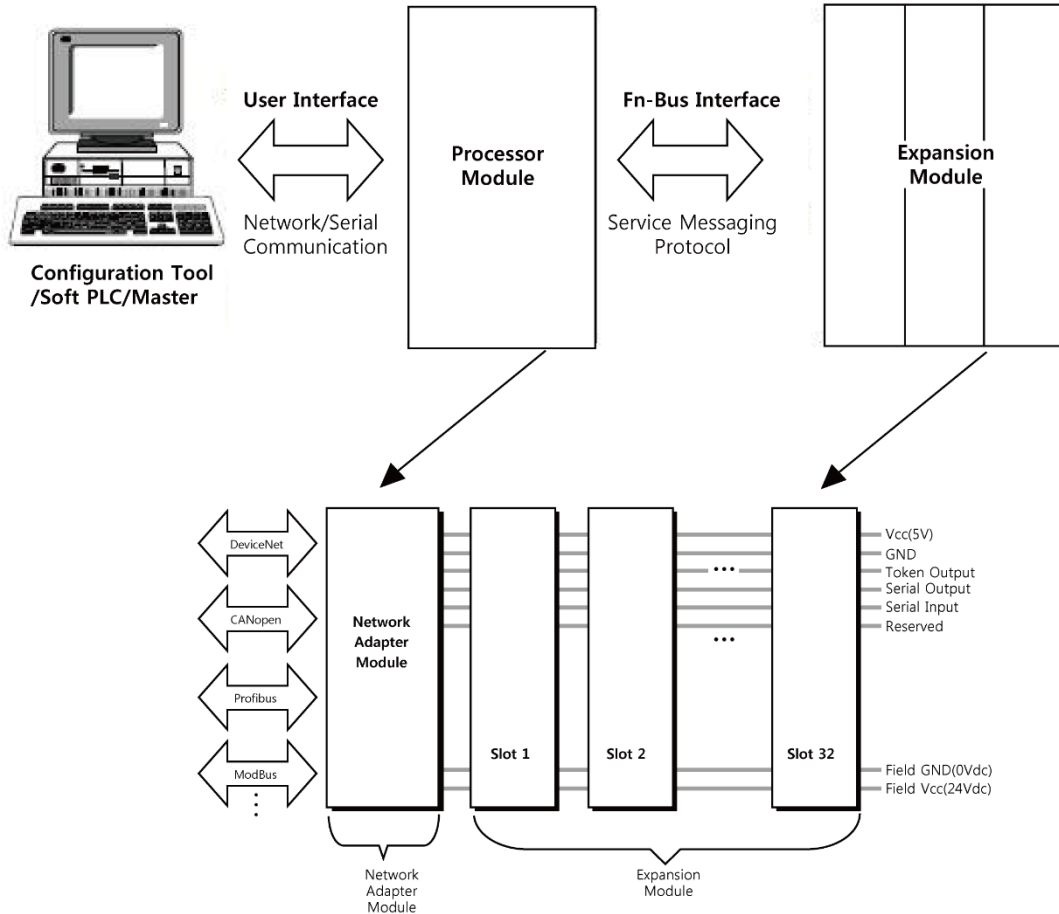

• **Network Adapter Module**

The Network Adapter Module forms the link between the field bus and the field devices with the Expansion Modules.

The connection to different field bus systems can be established by each of the corresponding Network Adapter Module, e.g. for SyncNet, PROFIBUS, CANopen, DeviceNet, Ethernet/IP, CC-Link, MODBUS/Serial, MODBUS/TCP etc.



- **Expansion Module**

The Expansion Modules are supported a variety of input and output field devices. There are digital and analog input/output modules and special function modules.

- **Two types of FnBus Message**

- Service Messaging
- I/O Messaging

#### **FnBus Pin Description**

<b>No.</b>	<b>Name</b>	<b>Description</b>
1	Vcc	System supply voltage (5V dc).
2	GND	System Ground.
3	Token Output	Token output port of Processor module.
4	Serial Output	Transmitter output port of Processor module.
5	Serial Input	Receiver input port of Processor module.
6	Reserved	Reserved for bypass Token.
7	Field GND	Field Ground.
8	Field Vcc	Field supply voltage (24Vdc).

## 6. GN-9285 Communication Interface

### 6.1. RJ-45 Socket

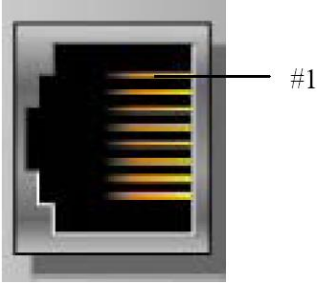

Shielded RJ-45 Socket

RJ-45	Signal Name	Description
1	TRX1+	TRX1+
2	TRX1-	TRX1-
3	TRX2+	TRX2+
4	TRX2-	TRX2-
5	TRX3+	TRX3+
6	TRX3-	TRX3-
7	TRX4+	TRX4+
8	TRX4-	TRX4-
Case	Shield	

### 6.2. Dip Switch (TBD)

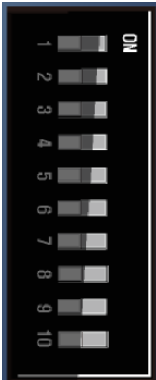

DIP Pole#	Description	
1	Node ID #0	Min. 1 ~ Max. 120 #default Node ID : 1
2	Node ID #	
3	Node ID #	
4	Node ID #	
5	Node ID #	
6	Node ID #	
7	Node ID #	
8	Node ID #	
9	Fault Action	OFF : Hold Last Value ON : Clear All Output Value
10	= ON : Firmware Upgrade	

## 7. MODBUS Interface

### 7.1 MODBUS Interface Register/Bit Map

- Register Map

Start Address	Read/Write	Description	Func. Code
0x0000 ~	Read	Process input image register(Rwr)	3,4,23
0x0800 ~	Read/Write	Process output image register(Rww)	3,16,23
0x8000 ~	Read	Process input image bit (Rx)	3,4,23
0x8800 ~	Read/Write	Process output image bit (Ry)	3,5,15,23
0x1000 *	Read	Adapter Identification special registers.	3,4,23
0x1100 *	Read	Adapter information special register.	3,4,6,23
0x2000 *	Read/Write	Expansion Slot Information special registers.	3,4,6,16,23

\* The special register map must be accessed by read/write of every each address (one address).

- Register Map

Start Address	Read/Write	Description	Func. Code
0x0000~	Read	Process input image bits All input registers area are addressable by bit address. Size of input image bit is size of input image register * 16.	2
0x1000~	Read/Write	Process output image bits All output registers area are addressable by bit address. Size of output image bit is size of output image register * 16.	1,5,15

## 7.2 Supported MODBUS Function Codes

Function Code	Function	Description
1(0x01)	Read Coils (Read output bit)	This function code is used to read from 1 to 2000 contiguous status of coils in a remote device. The Request PDU specifies the starting address, i.e. the address of the first coil specified, and the number of coils. In the PDU Coils are addressed starting at zero. Therefore coils numbered 1-16 are addressed as 0-15. The coils in the response message are packed as one coil per bit of the data field. Status is indicated as 1= ON and 0= OFF.
2(0x02)	Read Discrete Inputs (Read input bit)	This function code is used to read from 1 to 2000 contiguous status of discrete inputs in a remote device. The Request PDU specifies the starting address, i.e. the address of the first input specified, and the number of inputs. In the PDU Discrete Inputs are addressed starting at zero. Therefore Discrete inputs numbered 1-16 are addressed as 0-15. The discrete inputs in the response message are packed as one input per bit of the data field. Status is indicated as 1= ON; 0= OFF.
3(0x03)	Read Holding Registers (Read output word)	This function code is used to read the contents of a contiguous block of holding registers in a remote device. The Request PDU specifies the starting register address and the number of registers. The register data in the response message are packed as two bytes per register, with the binary contents right justified within each byte. For each register, the first byte contains the high order bits and the second contains the low order bits.
4(0x04)	Read Input Registers (Read input word)	This function code is used to read from 1 to approx. 125 contiguous input registers in a remote device. The Request PDU specifies the starting register address and the number of registers. The register data in the response message are packed as two bytes per register, with the binary contents right justified within each byte. For each register, the first byte contains the high order bits and the second contains the low order bits.
5(0x05)	Write Single Coil (Write one bit output)	This function code is used to write a single output to either ON or OFF in a remote device. The requested ON/OFF state is specified by a constant in the request data field. A value of FF 00 hex requests the output to be ON. A value of 00 00 requests it to be OFF. All other values are illegal and will not affect the output.
6(0x06)	Write Single Register (Write one word output)	This function code is used to write a single holding register in a remote device. Therefore register numbered 1 is addressed as 0. The normal response is an echo of the request, returned after the register contents have been written.
8(0x08)	Diagnostics	MODBUS function code 08 provides a series of tests

	(Read diagnostic register) *Refer to the 4.2.1	for checking the communication system between a client ( Master) device and a server ( Slave), or for checking various internal error conditions within a server. The function uses a two-byte sub-function code field in the query to define the type of test to be performed. The server echoes both the function code and sub-function code in a normal response. Some of the diagnostics cause data to be returned from the remote device in the data field of a normal response.
15(0x0F)	Write Multiple Coils (Write a number of output bits)	This function code is used to force each coil in a sequence of coils to either ON or OFF in a remote device. The Request PDU specifies the coil references to be forced. Coils are addressed starting at zero. A logical '1' in a bit position of the field requests the corresponding output to be ON. A logical '0' requests it to be OFF. The normal response returns the function code, starting address, and quantity of coils forced.
16(0x10)	Write Multiple registers (Write a number of output words)	This function code is used to write a block of contiguous registers (1 to approx. 120 registers) in a remote device. The requested written values are specified in the request data field. Data is packed as two bytes per register. The normal response returns the function code, starting address, and quantity of registers written.
23(0x17)	Read/Write Multiple registers (Read a number of input words /Write a number of output words)	Read a number of input words /Write a number of output words This function code performs a combination of one read operation and one write operation in a single MODBUS transaction. The write operation is performed before the read. The request specifies the starting address and number of holding registers to be read as well as the starting address, number of holding registers, and the data to be written. The byte count specifies the number of bytes to follow in the write data field. The normal response contains the data from the group of registers that were read. The byte count field specifies the quantity of bytes to follow in the read data field.

- Refer to MODBUS APPLICATION PROTOCOL SPECIFICATION V1.1a

**Sub-function 0x0000(0) Return Query Data**

The data passed in the request data field is to be returned (looped back) in the response.  
The entire response message should be identical to the request.

Sub-function	Data Field (Request)	Data Field (Response)	Description
0x0000(0)	Any	Echo Request Data	

**Sub-function 0x0001(1) Restart Communications Option**

The remote device could be initialized and restarted, and all of its communications event counters are cleared. Especially, data field 0x55AA make the remote device to restart with factory default setup of EEPROM.

Sub-function	Data Field (Request)	Data Field (Response)	Description
0x0001(1)	0x0000, 0xFF00	Echo Request Data	Reset Only
0x0001(1)	0x55AA+0xAA55+Sumcheck	Echo Request Data	Reset with Factory default

**Sub-function 0x000B(11) Return Bus Message Count**

The response data field returns the quantity of messages that the remote device has detected on the communications system since its last restart, clear counters operation, or power-up.

Sub-function	Data Field (Request)	Data Field (Response)	Description
0x000B(11)	0x0000	Total Message Count	

**Sub-function 0x000C(12) Return Bus Communication Error Count**

The response data field returns the quantity of CRC errors encountered by the remote device since its last restart, clear counters operation, or power-up.

Sub-function	Data Field (Request)	Data Field (Response)	Description
0x000C(12)	0x0000	CRC Error Count	

**Sub-function 0x000D(13) Return Bus Exception Error Count**

The response data field returns the quantity of MODBUS exception responses returned by the remote device since its last restart, clear counters operation, or power-up.

Exception responses are described and listed in section 3.2.11.

Sub-function	Data Field (Request)	Data Field (Response)	Description
0x000D(13)	0x0000	Exception Error Count	

**Sub-function 0x000E(14) Return Slave Message Count**

The response data field returns the quantity of messages addressed to the remote device, or broadcast, that the remote device has processed since its last restart, clear counters operation, or power-up.

Sub-function	Data Field (Request)	Data Field (Response)	Description
0x000E(14)	0x0000	Slave Message Count	

**Sub-function 0x000F(15) Return Slave No Response Count**

The response data field returns the quantity of messages addressed to the remote device for which it has returned no response (neither a normal response nor an exception response), since its last restart, clear counters operation, or power-up.

Sub-function	Data Field (Request)	Data Field (Response)	Description
0x000F(15)	0x0000	Slave No Response Count	

**Sub-function 0x0064(100) Return Slave ModBus, Internal Status**

The response data field returns the status of ModBus and Internal addressed to the remote device. This status values are identical with status 1 word of input process image.

Sub-function	Data Field (Request)	Data Field (Response)	Description
0x0064(100)	0x0000	ModBus, Internal Status	Same as status 1 word

## Error Response

In an exception response, the server sets the MSB of the function code to 1. This makes the function code value in an exception response exactly 80 hexadecimal higher than the value would be for a normal response.

- **Exception Codes**

Exception Code	Name	Description
01	Illegal Function	The function code received in the query is not an allowable action for the server (or slave).
02	Illegal Data Address	The data address received in the query is not an allowable address for the server (or slave).
03	Illegal Data Value	A value contained in the query data field is not an allowable value for server (or slave).
04	Slave Device Failure	An unrecoverable error occurred while the server (or slave) was attempting to perform the requested action.
05	Acknowledge	The server (or slave) has accepted the request and is processing it, but a long duration of time will be required to do so.
06	Slave Device Busy	Specialized use in conjunction with programming commands. The server (or slave) is engaged in processing a long-duration program command. The client (or master) should retransmit the message later when the server (or slave) is free.
08	Memory Parity Error	The server (or slave) attempted to read record file, but detected a parity error in the memory. The client (or master) can retry the request, but service may be required on the server (or slave) device.
0A	Gateway Path Unavailable	Specialized use in conjunction with gateways, indicates that the gateway was unable to allocate an internal communication path from the input port to the output port for processing the request.

## 7.3 MODBUS Special Register Map

The special register map can be accessed by function code 3, 4, 6 and 16. Also the special register map must be accessed by read/write of every each address (one address).

### Adapter Identification Special Register (0x1000, 4096)

Address	Access	Type, Size	Description
0x1000(4096)	Read	1word	Vendor ID = 0x02E5(741), Crevis. Co., Ltd.
0x1001(4097)	Read	1word	Device type = 0x000C, Network Adapter
0x1002(4098)	Read	1word	Product code = 0x90C0(GN-9285)
0x1003(4099)	Read	1word	Firmware revision, if 0x0100, revision 1.00
0x1004(4100)	Read	2words	Product unique serial number
0x1005(4101)	Read	String upto 34bytes	Product name string (ASCII) "GN9285_CC-Link_IE_Adapter"
0x1010(4112)	Read	2words	Firmware release date
0x1013(4115)	Read	1word	Firmware Code = 0x9285
0x101E(4126)	Read	7words - 1word - 1word - 1word - 1word - 1word - 2words	Composite Id of following address 0x1100(4352), Modbus RS232 Node. (Fixed 0x0001) 0x1000(4096), Vendor ID 0x1001(4097), Device type 0x1002(4098), Product code 0x1003(4099), Firmware revision 0x1004(4100), Product serial number

- String Type consist of valid string length (first 1word) and array of characters

### Adapter Information Special Register (0x1100, 4352)

Address	Access	Type, Size	Description
0x1102(4354)	Read	1word	Start address of input image word register. =0x0000
0x1103(4355)	Read	1word	Start address of output image word register. =0x0800
0x1104(4356)	Read	1word	Size of input image word register. = 0x0078
0x1105(4357)	Read	1word	Size of output image word register. = 0x0078
0x1106(4358)	Read	1word	Start address of input image bit. = 0x8000
0x1107(4359)	Read	1word	Start address of output image bit. =0x8800
0x1108(4360)	Read	1word	Size of input image bit.= 0x780
0x1109(4361)	Read	1word	Size of output image bit. = 0x780
0x110A(4362)	Read	1word	Update time for cyclic data change (same as 0x1028)
0x110D(4365)	Read	1word	Current Dip Switch State and Field Power Status (MSB) ex) Dip SW(0x01), Field Power On = 0x8001
0x110E(4366)	Read	upto 33words	Expansion slot's ST-number including NA First 1word is adapter's number, if GN-9289, then 0x9289



0x1110(4368)	Read	1word	Number of expansion slot
0x1113(4371)	Read	upto 33words	Expansion slot Module Id. Refer to Appendix A.1 Product List. First 1word is adapter's module id.
0x1119(4377)	Read	1word	Hi byte is ModBus status, low byte is internal status. Zero value means 'no error'.

\*After the system is reset, the new "Set Value" action is applied.

\*\* If the slot location is changed, set default value automatically (all expansion slot are live).

**Expansion Slot Information Special Register (0x2000, 8192)**

Each expansion slot has 0x20(32) address offset and same information structure.

Slot#1	0x2000(8192)~0x201F(8223)	Slot#2	0x2020(8224)~0x203F(8255)
Slot#3	0x2040(8256)~0x205F(8287)	Slot#4	0x2060(8288)~0x207F(8319)
Slot#5	0x2080(8320)~0x209F(8351)	Slot#6	0x20A0(8352)~0x20BF(8383)
Slot#7	0x20C0(8384)~0x20DF(8415)	Slot#8	0x20E0(8416)~0x20FF(8447)
Slot#9	0x2100(8448)~0x211F(8479)	Slot#10	0x2120(8480)~0x213F(8511)
Slot#11	0x2140(8512)~0x215F(8543)	Slot#12	0x2160(8544)~0x217F(8575)
Slot#13	0x2180(8576)~0x219F(8607)	Slot#14	0x21A0(8608)~0x21BF(8639)
Slot#15	0x21C0(8640)~0x21DF(8671)	Slot#16	0x21E0(8672)~0x21FF(8703)
Slot#17	0x2200(8704)~0x221F(8735)	Slot#18	0x2220(8736)~0x223F(8767)
Slot#19	0x2240(8768)~0x225F(8799)	Slot#20	0x2260(8800)~0x227F(8831)
Slot#21	0x2280(8832)~0x229F(8863)	Slot#22	0x22A0(8864)~0x22BF(8895)
Slot#23	0x22C0(8896)~0x22DF(8927)	Slot#24	0x22E0(8928)~0x22FF(8959)
Slot#25	0x2300(8960)~0x231F(8991)	Slot#26	0x2320(8992)~0x233F(9023)
Slot#27	0x2340(9024)~0x235F(9055)	Slot#28	0x2360(9056)~0x237F(9087)
Slot#29	0x2380(9088)~0x239F(9119)	Slot#30	0x23A0(9120)~0x23BF(9151)
Slot#31	0x23C0(9152)~0x23DF(9183)	Slot#32	0x23E0(9184)~0x23FF(9215)
Slot#33	0x2400(9216)~0x241F(9247)	Slot#34	0x2420(9248)~0x243F(9279)

.....  
Slot#63 0x27C0(10176)~0x27DF(10207)

Address Offset	Expansion Slot#1	Expansion Slot#2	Expansion Slot#3	Expansion Slot#4	.....	Expansion Slot#63
+ 0x00(+0)	0x2000(8192)	0x2020(8224)	0x2040(8256)	0x2060(8288)	.....	0x27C0(10176)
+ 0x01(+1)	0x2001(8193)	0x2021(8225)	0x2041(8257)	0x2061(8289)	.....	0x27C1(10177)
+ 0x02(+2)	0x2002(8194)	0x2022(8226)	0x2042(8258)	0x2062(8290)	.....	0x27C2(10178)
+ 0x03(+3)	0x2003(8195)	0x2023(8227)	0x2043(8259)	0x2063(8291)	.....	0x27C3(10179)
+ 0x04(+4)	0x2004(8196)	0x2024(8228)	0x2044(8260)	0x2064(8292)	.....	0x27C4(10180)
+ 0x05(+5)	0x2005(8197)	0x2025(8229)	0x2045(8261)	0x2065(8293)	.....	0x27C5(10181)
+ 0x06(+6)	0x2006(8198)	0x2026(8230)	0x2046(8262)	0x2066(8294)	.....	0x27C6(10182)
+ 0x07(+7)	0x2007(8199)	0x2027(8231)	0x2047(8263)	0x2067(8295)	.....	0x27C7(10183)
+ 0x08(+8)	0x2008(8200)	0x2028(8232)	0x2048(8264)	0x2068(8296)	.....	0x27C8(10184)
+ 0x09(+9)	0x2009(8201)	0x2029(8233)	0x2049(8265)	0x2069(8297)	.....	0x27C9(10185)
+ 0x0A(+10)	0x200A(8202)	0x202A(8234)	0x204A(8266)	0x206A(8298)	.....	0x27CA(10186)
+ 0x0B(+11)	0x200B(8203)	0x202B(8235)	0x204B(8267)	0x206B(8299)	.....	0x27CB(10187)
+ 0x0C(+12)	0x200C(8204)	0x202C(8236)	0x204C(8268)	0x206C(8300)	.....	0x27CC(10188)
+ 0x0D(+13)	0x200D(8205)	0x202D(8237)	0x204D(8269)	0x206D(8301)	.....	0x27CD(10189)

+ 0x0E(+14)	0x200E(8206)	0x202E(8238)	0x204E(8270)	0x206E(8302)	.....	0x27CE(10190)
+ 0x0F(+15)	0x200F(8207)	0x202F(8239)	0x204F(8271)	0x206F(8303)	.....	0x27CF(10191)
+ 0x10(+16)	0x2010(8208)	0x2030(8240)	0x2050(8272)	0x2070(8304)	.....	0x27D0(10192)
+ 0x11(+17)	0x2011(8209)	0x2031(8241)	0x2051(8273)	0x2071(8305)	.....	0x27D1(10193)
+ 0x12(+18)	0x2012(8210)	0x2032(8242)	0x2052(8274)	0x2072(8306)	.....	0x27D2(10194)
+ 0x13(+19)	0x2013(8211)	0x2033(8243)	0x2053(8275)	0x2073(8307)	.....	0x27D3(10195)
+ 0x14(+20)	0x2014(8212)	0x2034(8244)	0x2054(8276)	0x2074(8308)	.....	0x27D4(10196)
+ 0x15(+21)	0x2015(8213)	0x2035(8245)	0x2055(8277)	0x2075(8309)	.....	0x27D5(10197)
+ 0x16(+22)	0x2016(8214)	0x2036(8246)	0x2056(8278)	0x2076(8310)	.....	0x27D6(10198)
+ 0x17(+23)	0x2017(8215)	0x2037(8247)	0x2057(8279)	0x2077(8311)	.....	0x27D7(10199)
+ 0x18(+24)	0x2018(8216)	0x2038(8248)	0x2058(8280)	0x2078(8312)	.....	0x27D8(10200)
+ 0x19(+25)	0x2018(8217)	0x2038(8249)	0x2058(8281)	0x2078(8313)	.....	0x27D9(10201)
+ 0x1A(+26)	0x201A(8218)	0x203A(8250)	0x205A(8282)	0x207A(8314)	.....	0x27DA(10202)
+ 0x1B(+27)	0x201B(8219)	0x203B(8251)	0x205B(8283)	0x207B(8315)	.....	0x27DB(10203)
+ 0x1C(+28)	0x201C(8220)	0x203C(8252)	0x205C(8284)	0x207C(8316)	.....	0x27DC(10204)
+ 0x1D(+29)	0x201D(8221)	0x203D(8253)	0x205D(8285)	0x207D(8317)	.....	0x27DD(10205)
+ 0x1E(+30)	0x201E(8222)	0x203E(8254)	0x205E(8286)	0x207E(8318)	.....	0x27DE(10206)
+ 0x1F(+31)	0x201F(8223)	0x203F(8255)	0x205F(8287)	0x207F(8319)	.....	0x27DF(10207)

Address Offset	Access	Type, Size	Description
+ 0x02(+2) **	Read	1 word	Input start register address of input image word this slot.
+ 0x03(+3) **	Read	1 word	Input word's bit offset of input image word this slot.
+ 0x04(+4) **	Read	1 word	Output start register address of output image word this slot.
+ 0x05(+5) **	Read	1 word	Output word's bit offset of output image word this slot.
+ 0x06(+6) **	Read	1 word	Input bit start address of input image bit this slot.
+ 0x07(+7) **	Read	1 word	Output bit start address of output image bit this slot.
+ 0x08(+8) **	Read	1 word	Size of input bit this slot
+ 0x09(+9) **	Read	1 word	Size of output bit this slot
+ 0x0A(+10)**	Read	n word	Read input data this slot
+ 0x0B(+11)**	Read	n word	Read output data this slot
+ 0x0E(+14)	Read	1 word	ST-number, if ST-1218, returns 0x1218
+ 0x0F(+15)	Read	String upto 72byte	First 1 word is length of valid character string. If ST-1218, returns "00 20 53 54 2D 31 32 31 38 2C 20 46 6E 49 4F 20 38 20 53 69 6E 6B 69 6E 67 20 49 6E 20 32 34 56 64 63" Valid character size = 0x001E =30 characters, "GT-1218, FnIO 8 Sinking In 24Vdc"
+ 0x10(+16)	Read	1 word	Size of configuration parameter byte
+ 0x11(+17)**	Read/Write	n word	Read/write Configuration parameter data, up to 8byte. Refer to A.2 ***
+ 0x17(+23)	Read	2word	Firmware Revision ex) 0x00010010 (Major revision 1 /Minor revision 1, Rev 1.001)

\* After the system is reset, the new "Set Value" action is applied.

\*\* Nothing of output, input, memory or configuration parameter corresponding slot returns Exception 02.

## 7.4 MODBUS Reference

MODBUS Reference Documents

<http://www.modbus.org>

MODBUS Tools

<http://www.modbustools.com>, modbus poll

<http://www.win-tech.com>, modscan32

## 8. Trouble Shooting

### 8.1. How to diagnose by LED indicator

LED Status	Cause	Action
All LED turns off	- No power	- Check main power Cable
MOD LED is red	- Occurrence critical error in firmware	- Contact Sales team and send module for repair.
DLINK LED turn off	- Disconnected	- Check the communication cable or communication setting.
DLINK LED Flashing Green	- Cyclic transmission is not being performed	- Check the status of the master.
RUN/ERR turn off	- Device is idle or may not be powered.	- Check main power Cable
RUN/ERR Flashing Red	- Duplication of slave stations	- Check IP of slave stations
RUN/ERR is red	- Duplication of master stations - Invalid the occupied stations	- Check IP of slave stations - Check the occupied stations
IOS LED turns off	- Device may not be powered.	- Check main power Cable
IOS LED flashes red	- Adapter has no expansion module	- Add one or more expansion modules.
IOS LED is red	One or more expansion module occurred in fault state. - Detected invalid expansion module ID. - Overflowed Input/Output Size - Too many expansion module - Initialization failure - Communication failure. - Changed expansion module configuration. - Mismatch vendor code between adapter and expansion module.	- Use expansion slot up to 32. - Compose that IO total size is not excess. - Check status of expansion IO connection. - Check the vendor code of module.
Field Power LED turns off	- Field power is not supplied.	- Check main power Cable - Contact Sales team and send module for repair.
System Power LED turns off	- System power is not supplied.	- Check main power Cable - Contact Sales team and send module for repair.

## APPENDIX A

### A.1. Product List

No.	GT-Number	Description	ID(hex)
<b>Digital Input Module</b>			
1	GT-1238	8 Points, Universal, 24Vdc, 10RTB	1238
2	GT-123F	16 Points, Universal, 24Vdc, 20P connector	123F
3	GT-12DF	16 Points, Universal, 24Vdc, 18RTB	12DF
4	GT-12FA	32 Points, Universal, 24Vdc, 40P connector	12FA
5	GT-1428	8 Sink Input / 8 Source Output with Diagnostic, 24Vdc	1428
6	GT-1804	4 Points, 120Vac, 10RTB	1804
7	GT-1904	4 Points, 240Vac, 10RTB	1904
<b>Digital Output Module</b>			
8	GT-2318	8 Points, Sink, 24Vdc/0.5A, 10RTB	2318
9	GT-2328	8 Points, Source, 24Vdc/0.5A, 10RTB	2328
10	GT-221F	16 Points, Sink, 24Vdc/0.3A, 20P connector	221F
11	GT-222F	16 Points, Source, 24Vdc/0.3A, 20P connector	222F
12	GT-225F	16 Points, Sink, 24Vdc/0.3A, 18RTB	225F
13	GT-226F	16 Points, Source, 24Vdc/0.3A, 18RTB	226F
14	GT-22BA	32 Points, Sink, 24Vdc/0.3A, 40P connector	22BA
15	GT-22CA	32 Points, Source, 24Vdc/0.3A, 40P connector	22CA
16	GT-2418	8 Channels Sink Output with Diagnostics	2418
17	GT-2428	8 Channels Source Output with Diagnostics	2428
18	GT-2618	8 Points, Sink, 24Vdc/2A, 10RTB	2618
19	GT-2628	8 Points, Source, 24Vdc/2A, 10RTB	2628
20	GT-2734	4 Points, MOS Relay, 240Vdc/ac, 0.5A, 10RTB	2734
21	GT-2738	8 Points, MOS Relay Output Terminal, 240Vdc, 0.5A	2738
22	GT-2744	4 Points, Relay, 24Vdc/2A, 240Vac/2A, 10RTB	2744
23	GT-2764	4 Points, MOS Relay, 24Vdc/ac, 2A, 10RTB	2764
24	GT-2768	8 Points, Relay Output Terminal, 24Vdc/ac, 2A	2768
25	GT-2784	4 Points, MOS Relay, 110Vdc/ac, 1A, 10RTB	2784
26	GT-2788	8 Points, Relay Output Terminal, 110Vdc/ac, 1A	2788
<b>Analog Input Module</b>			
27	GT-3002	2ch load cell input unit, strain gauge	3002
28	GT-3114	4 Channels, 0~20, 4~20mA, 12bits, 10RTB	3114
29	GT-3154	4 Channels, 0~20, 4~20mA, 16bits, 10RTB	3154
30	GT-3118	8 Channels, 0~20, 4~20mA, 12bits, 10RTB	3118
31	GT-3158	8 Channels, 0~20, 4~20mA, 16bits, 10RTB	3158
32	GT-311F	16 Channels, 0~20, 4~20mA, 12bits, 20P connector	311F
33	GT-315F	16 Channels, 0~20, 4~20mA, 16bits, 20P connector	315F
34	GT-317F	16 Channels, 0~20, 4~20mA, 12bits, 18RTB	317F
35	GT-319F	16 Channels, 0~20, 4~20mA, 16bits, 18RTB	319F
36	GT-3424	4 Channels, 0~10, 0~5, 1~5Vdc, 12bits, 10RTB	3424
37	GT-3464	4 Channels, 0~10, 0~5, 1~5Vdc, 16bits, 10RTB	3464
38	GT-3428	8 Channels, 0~10, 0~5, 1~5Vdc, 12bits, 10RTB	3428
39	GT-3468	8 Channels, 0~10, 0~5, 1~5Vdc, 16bits, 10RTB	3468
40	GT-342F	16 Channels, 0~10, 0~5, 1~5Vdc, 12bits, 20P connector	342F

41	GT-346F	16 Channels, 0~10, 0~5, 1~5Vdc, 16bits, 20P connector	346F
42	GT-347F	16 Channels, 0~10, 0~5, 1~5Vdc, 12bits, 18RTB	347F
43	GT-349F	16 Channels, 0~10, 0~5, 1~5Vdc, 16bits, 18RTB	349F
44	GT-3704	4 Channels, RTD, 10RTB	3704
45	GT-3708	8 Channels, RTD, 20P connector	3708
46	GT-3804	4 Channels, Thermocouple, 10RTB	3804
47	GT-3808	8 Channels, Thermocouple, 20P connector	3808
48	GT-3714	4 Channels, TEMP. Controller, RTD Input, SSR Output	3714
49	GT-3734	4 Channels, TEMP. Controller, RTD Input, Current Output	3734
50	GT-3814	4 Channels, TEMP. Controller, TC Input, SSR Output	3814
51	GT-3834	4 Channels, TEMP. Controller, TC Input, Current Output	3834
52	GT-3901	AC Measurement	3901
53	GT-3914	4 Channels, Differential, 0~20, 4~20, +/-20mA, 12Bits, 10RTB	3914
54	GT-3934	4 Channels, Differential, 0~20, 4~20, +/-20mA, 16Bits, 10RTB	3934
55	GT-3918	8 Channels, Differential, 0~20, 4~20, +/-20mA, 12Bits, 18RTB	3918
56	GT-3938	8 Channels, Differential, 0~20, 4~20, +/-20mA, 16Bits, 18RTB	3938
57	GT-3924	4 Channels, Differential, 0~5, 0~10, +/-5, +/-10Vdc, 12Bits, 10RTB	3924
58	GT-3944	4 Channels, Differential, 0~5, 0~10, +/-5, +/-10Vdc, 16Bits, 10RTB	3944
59	GT-3928	8 Channels, Differential, 0~5, 0~10, +/-5, +/-10Vdc, 12Bits, 18RTB	3928
60	GT-3948	8 Channels, Differential, 0~5, 0~10, +/-5, +/-10Vdc, 16Bits, 18RTB	3948
<b>Analog Output Module</b>			
61	GT-4114	4CH, 0~20mA, 12Bits, 10RTB	4114
62	GT-4154	4CH, 0~20mA, 16Bits, 10RTB	4154
63	GT-4118	8CH, 0~20mA, 12Bits, 10RTB	4118
64	GT-4158	8CH, 0~20mA, 16Bits, 10RTB	4158
65	GT-4214	4 Channels, Current Output, 4~20mA, 12bits	4214
66	GT-4254	4 Channels, Current Output, 4~20mA, 16bits	4254
67	GT-4218	8 CHANNELS CURRENT OUTPUT, 4~20mA, 12BIT	4218
68	GT-4258	8 CHANNELS CURRENT OUTPUT, 4~20mA, 16BIT	4258
69	GT-4424	4CH, 0~10Vdc, 12Bits, 10RTB	4424
70	GT-4464	4CH, 0~10Vdc, 16Bits, 10RTB	4464
71	GT-4428	8CH, 0~10Vdc, 12Bits, 10RTB	4428
72	GT-4468	8CH, 0~10Vdc, 16Bits, 10RTB	4468
73	GT-442F	16CH, 0~10Vdc, 12Bits, 20P Connector	442F
74	GT-446F	6CH, 0~10Vdc, 16Bits, 20P Connector	446F
75	GT-447F	16CH, 0~10Vdc, 12Bits, 18RTB	447F
76	GT-449F	16CH, 0~10Vdc, 16Bits, 18RTB	449F
77	GT-4524	AO 4 CHs, ±10Vdc, 12Bits, 10RTB	4524
78	GT-4564	AO 4 CHs, ±10Vdc, 16Bits, 10RTB	4564
<b>Special Module</b>			
79	GT-5102	2CH, Encoder, Input, 5Vdc, 10RTB	5102
80	GT-5112	High Speed Counter, 2CHs, 24Vdc, Encoder Input, 10RTB	5112
81	GT-5114	High Speed Counter, 4CHs, 24Vdc, Encoder Input, 10RTB	5114
82	GT-5211	1CH, RS 232, RTS/CTS, Full Duplex Type, 10RTB	5211
83	GT-5212	2CH, RS 232, Full Duplex Type, 10RTB	5212
84	GT-5221	1CH, RS 485, Full Duplex Type, 10RTB	5221
85	GT-5231	1CH, RS 485, Half Full Duplex Type, 10RTB	5231
86	GT-5232	2CH, RS 485, Half Full Duplex Type, 10RTB	5232

87	GT-5352	2CH, Synchronous Serial Interface Input, 10RTB	5352
88	GT-5442	PWM Output, 2CHs, 0.5A/24Vdc, Source, 18RTB	5442
89	GT-5444	PWM Output, 4CHs, 0.5A/24Vdc, Source, 18RTB	5444
90	GT-5642	Pulse Output, 2CHs, 0.5A/24Vdc, Source, 18RTB	5642
91	GT-5652	Pulse Output, 2CHs, RS422 (Differential), 18RTB	5652
92	GT-5521	1CH, Stepper Module (TBD)	5521
<b>Power Module</b>			
93	GT-7408	Shield Module	7408
94	GT-7508	Common for 0Vdc	7508
95	GT-7511	Power Expansion, In 24Vdc, Out 1A/5Vdc	7511
96	GT-7518	Common for 24Vdc	7518
97	GT-7588	Common for 0Vdc, 24Vdc	7588
98	GT-7641	Field Power, 5/24/48 Vdc, 110/220 Vac	7641
99	GT-7151	Noise Filter Module, 18RTB, None ID Type	7151
100	GT-7851	Noise Filter Module, 18RTB, ID Type	7851

## A.2. Glossary

- System Power: The power for starting up CPU.
- Field Power: The power for input and output line.
- Terminator Resistor: Resistor for prevention reflected wave.
- EDS: Electronic Data Sheet.
- sinking: The method of input and output what device does not have power source.
- sourcing: The method of input and output what device have power source.