



ESSENTRA

essentracomponents.com

© 2013 Essentra Components. All rights reserved.
Registered in England, Company No. 547495.
Registered Office: Avebury House,
201-249 Avebury Boulevard, Milton Keynes, MK9 1AU

Condition of Sale can be found on our website:
essentra.com.

Essentra Components does not warrant that the files will be error free and may create new versions ("Upgrades") at any time, which may correct such errors. Essentra Components has no obligation to notify you of such upgrades. Any upgraded file will be published to the website, when it becomes available.

You are not permitted to load any of the files on to a network server for the purposes of distribution to one or more other computer(s) on that network or to effect such distribution. Essentra Components shall not be liable for any loss or damage whatsoever or however caused, arising directly or indirectly from the use of the files.

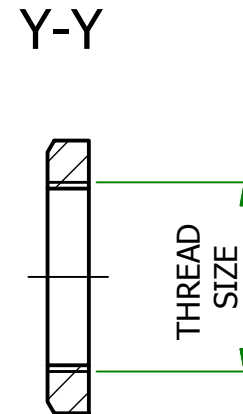
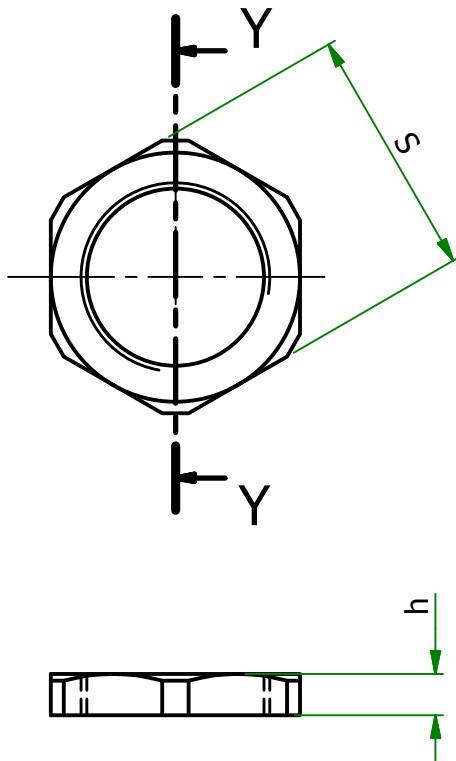

UNCONTROLLED

UNLESS OTHERWISE STATED

ALL DIMENSIONS IN mm			DO NOT SCALE
LINEAR TOLERANCE			THIRD ANGLE PROJECTION
SIZE	(0)	(0.0)	(0.00)
0-10mm	±0.5	±0.15	±0.10
10-30mm	±0.5	±0.20	±0.15
30-50mm	±0.5	±0.30	±0.20
50-100mm	±0.8	±0.50	±0.25
100-200mm	±1.5	±0.80	±0.40
200-300mm	±2.0	±1.20	±0.80
300-500mm	±3.0	±2.00	±1.00
+500mm	±5.0	±3.00	±1.50

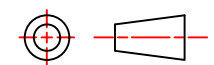

ANGULAR TOLERANCE ±0.5 DEGREES
UNSPECIFIED RADII 0.25mm
DRAFT ANGLE 0.5 DEGREES
DIMENSIONS IN BRACKETS [] ARE
IN INCHES FOR REFERENCE ONLY

ORG.SCALE NTS CREATE DATE 13/Sep/2014

MATERIAL NYLON/NEOPRANE

ITEM No. 467595

TITLE LOCKNUT AND SEALING
WASHER for CABLE GLAND

DWG.No. P110220-4-1

ISSUE No. 1

Part Number	Thread Size	S	h	Colour	Washer Part Number	Part ID
467595	PG 42	63.0 - 65.0	8	BLACK	467653	1148681