

UNCONTROLLED DOCUMENT

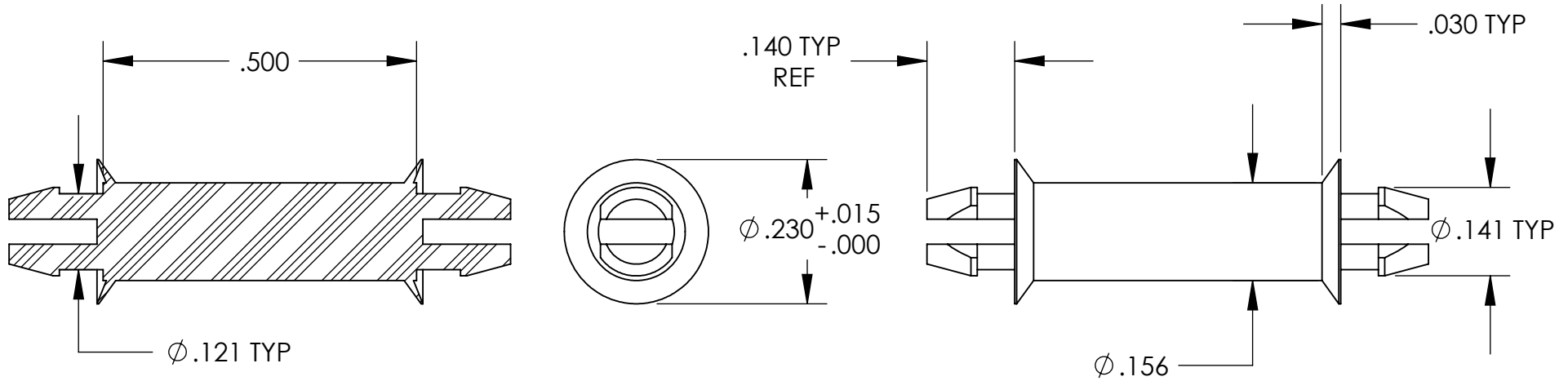

NOTES:
 BOTH ENDS FIT A .125 HOLE
 PANEL THICKNESS .062 ±.015

TOLERANCES UNLESS NOTED

- ±.005 ON DIMENSIONS THRU .625
- ±.008 ON DIMENSIONS .626 THRU 1.000
- ±.010 ON DIMENSIONS 1.001 THRU 1.500
- ±.015 ON DIMENSIONS LARGER THAN 1.500
- ±.015 ON FRACTIONAL DIMENSIONS

WE RESERVE THE RIGHT
 TO DISCONTINUE ITEMS,
 CHANGE SPECIFICATIONS
 OR DESIGN AT ANY TIME
 WITHOUT NOTICE AND
 WITHOUT INCURRING
 ANY OBLIGATIONS

PROPERTY OF		
MICRO PLASTICS INC.		
CATALOG DRAWING PCB SUPPORTS "DMSP SERIES" MICRO P/N 27DMSP00500 DWG. # 27DMSP00500 FILE SERVER\ENG\WEB		
MATERIAL:		NYLON 6/6
DATE	SCALE	SD
	4:1	