



ESSENTRA

COMPONENTS

essentracomponents.com

© 2013 Essentra Components. All rights reserved.
Registered in England, Company No. 547495.
Registered Office: Avebury House,
201-249 Avebury Boulevard, Milton Keynes, MK9 1AU

Condition of Sale can be found on our website:
essentra.com.

Essentra Components does not warrant that the files will be error free and may create new versions ("Upgrades") at any time, which may correct such errors. Essentra Components has no obligation to notify you of such upgrades. Any upgraded file will be published to the website, when it becomes available.

You are not permitted to load any of the files on to a network server for the purposes of distribution to one or more other computer(s) on that network or to effect such distribution. Essentra Components shall not be liable for any loss or damage whatsoever or however caused, arising directly or indirectly from the use of the files.

C-C (5 : 1)

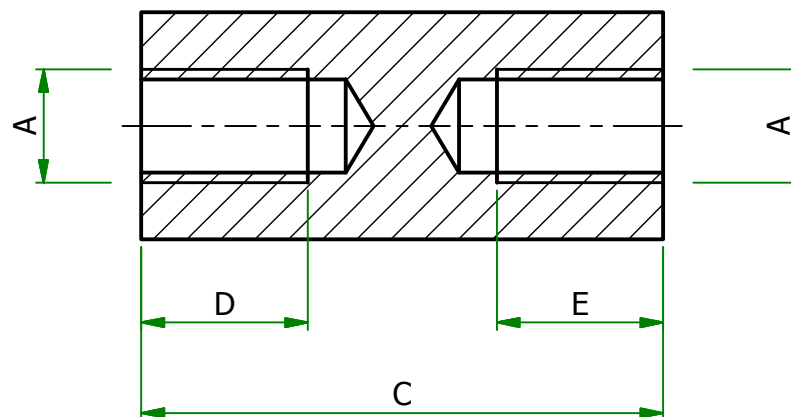
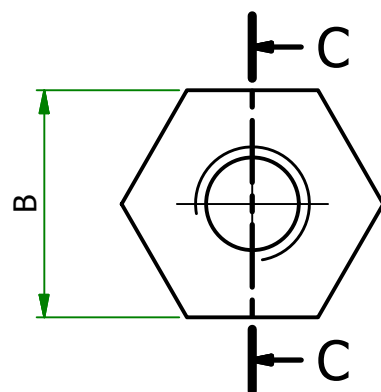

UNCONTROLLED

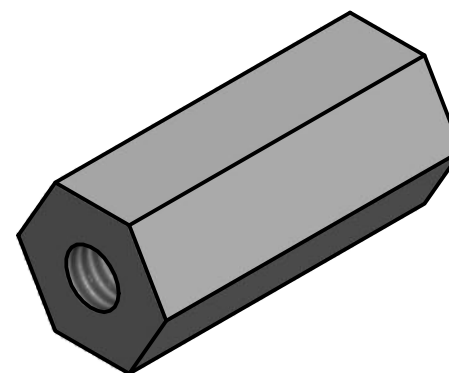

UNLESS OTHERWISE STATED

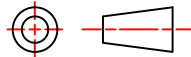
ALL DIMENSIONS IN mm				DO NOT SCALE	
LINEAR TOLERANCE				THIRD ANGLE PROJECTION	
SIZE	(0)	(0.0)	(0.00)	 ANGULAR TOLERANCE ±0.5 DEGREES UNSPECIFIED RADII 0.25mm DRAFT ANGLE 0.5 DEGREES	
0-10mm	±0.5	±0.15	±0.10		
10-30mm	±0.5	±0.20	±0.15		
30-50mm	±0.5	±0.30	±0.20		
50-100mm	±0.8	±0.50	±0.25		
100-200mm	±1.5	±0.80	±0.40		
200-300mm	±2.0	±1.20	±0.80		
300-500mm	±3.0	±2.00	±1.00		
+500mm	±5.0	±3.00	±1.50		

ORG.SCALE 5:1

MATERIAL NYLON + GF

ITEM No. 302308059935

TITLE HEXAGONAL F/F SPACER (Type-2)

DWG.No. 302... Series

ISSUE No. 1

Item	Colour	A	B	C	D	E
302308059935	BLACK	M3	6	8	4	4