

UNCONTROLLED DOCUMENT

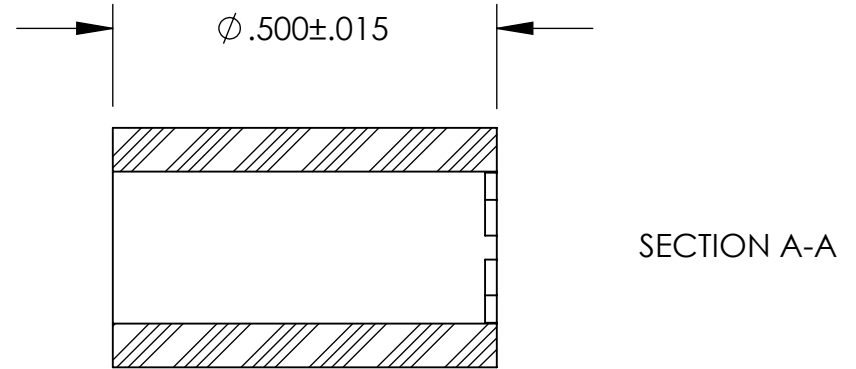
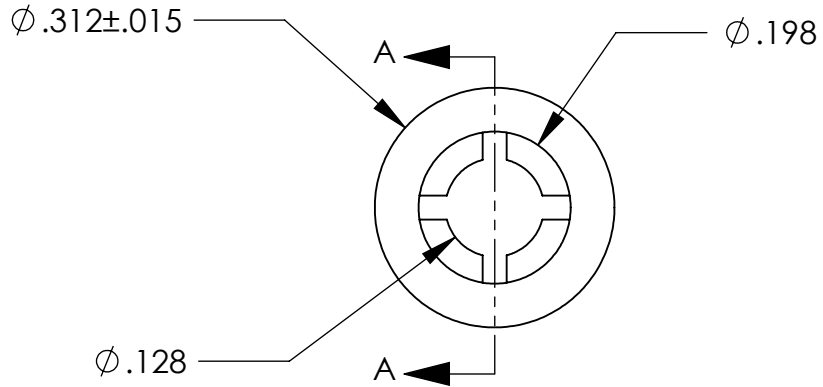

TOLERANCES UNLESS NOTED

- $\pm .005$ ON DIMENSIONS THRU $.625$
- $\pm .008$ ON DIMENSIONS $.626$ THRU 1.000
- $\pm .010$ ON DIMENSIONS 1.001 THRU 1.500
- $\pm .015$ ON DIMENSIONS LARGER THAN 1.500
- $\pm .015$ ON FRACTIONAL DIMENSIONS

WE RESERVE THE RIGHT
TO DISCONTINUE ITEMS,
CHANGE SPECIFICATIONS
OR DESIGN AT ANY TIME
WITHOUT NOTICE AND
WITHOUT INCURRING
ANY OBLIGATIONS

| | | |
|---|-------|-----------|
| PROPERTY OF | | |
| MICRO PLASTICS INC. | | |
| CATALOG DRAWING RETAINING SPACER MICRO P/N 13SPRT067 DWG. # 13SPRT067 FILE SERVER\ENG\WEB | | |
| MATERIAL: | | 6/6 NYLON |
| DATE | SCALE | TA |
| | 4:1 | |