

UNCONTROLLED DOCUMENT

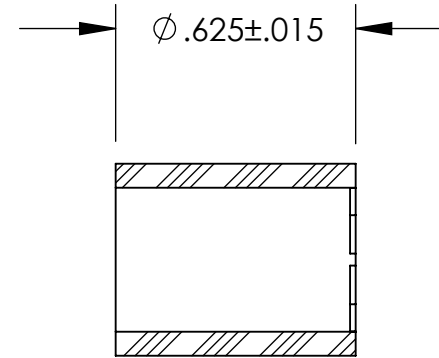
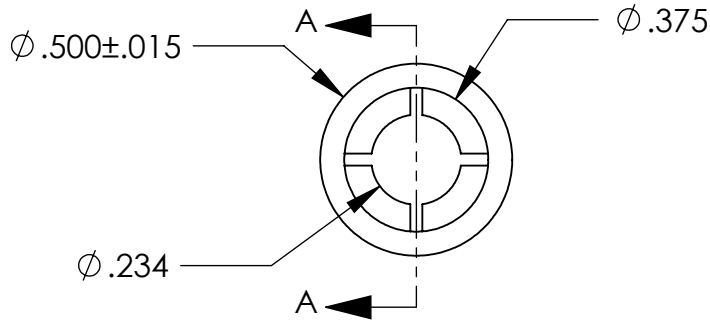

TOLERANCES UNLESS NOTED

- $\pm .005$ ON DIMENSIONS THRU $.625$
- $\pm .008$ ON DIMENSIONS $.626$ THRU 1.000
- $\pm .010$ ON DIMENSIONS 1.001 THRU 1.500
- $\pm .015$ ON DIMENSIONS LARGER THAN 1.500
- $\pm .015$ ON FRACTIONAL DIMENSIONS

WE RESERVE THE RIGHT
 TO DISCONTINUE ITEMS,
 CHANGE SPECIFICATIONS
 OR DESIGN AT ANY TIME
 WITHOUT NOTICE AND
 WITHOUT INCURRING
 ANY OBLIGATIONS

PROPERTY OF		
MICRO PLASTICS INC.		
CATALOG DRAWING RETAINING SPACER MICRO P/N 13SPRT114 DWG. # 13SPRT114 FILE SERVER\ENG\WEB		
MATERIAL:		6/6 NYLON
DATE	SCALE	TA
	2:1	