

CUT OUT

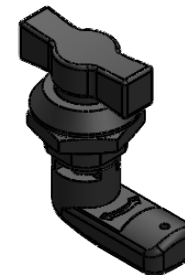
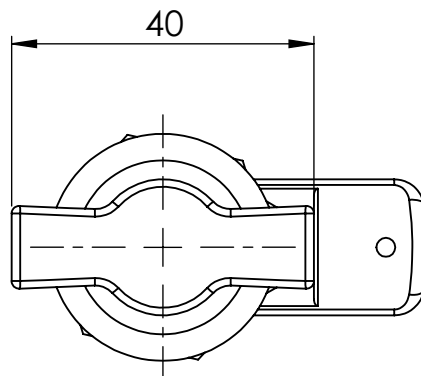

1:2

NOTE

MATERIAL
 HOUSING : PA6GFR30
 KNOB : PA6GFR30
 NUT : PA6GFR30
 CAM : PA6GFR30
 GASKET : RUBBER

ACTION : LH/RH

AWAITING APPROVAL

UNLESS OTHERWISE STATED

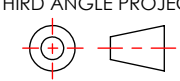
ALL DIMENSIONS IN mm	DO NOT SCALE																																				
LINEAR TOLERANCE	THIRD ANGLE PROJECTION																																				
<table border="1"> <tr> <th>SIZE</th> <th>(0)</th> <th>(0.0)</th> <th>(0.00)</th> </tr> <tr> <td>0-10mm</td> <td>±0.5</td> <td>±0.15</td> <td>±0.10</td> </tr> <tr> <td>>10-30</td> <td>±0.5</td> <td>±0.20</td> <td>±0.15</td> </tr> <tr> <td>>30-50</td> <td>±0.5</td> <td>±0.30</td> <td>±0.20</td> </tr> <tr> <td>>50-100</td> <td>±0.8</td> <td>±0.50</td> <td>±0.25</td> </tr> <tr> <td>>100-200</td> <td>±1.5</td> <td>±0.80</td> <td>±0.40</td> </tr> <tr> <td>>200-300</td> <td>±2.0</td> <td>±1.20</td> <td>±0.80</td> </tr> <tr> <td>>300-500</td> <td>±3.0</td> <td>±2.00</td> <td>±1.00</td> </tr> <tr> <td>>500</td> <td>±5.0</td> <td>±3.00</td> <td>±1.50</td> </tr> </table>	SIZE	(0)	(0.0)	(0.00)	0-10mm	±0.5	±0.15	±0.10	>10-30	±0.5	±0.20	±0.15	>30-50	±0.5	±0.30	±0.20	>50-100	±0.8	±0.50	±0.25	>100-200	±1.5	±0.80	±0.40	>200-300	±2.0	±1.20	±0.80	>300-500	±3.0	±2.00	±1.00	>500	±5.0	±3.00	±1.50	 ANGULAR TOLERANCE ±0.5 DEGREES UNSPECIFIED RADII 0.25mm DRAFT ANGLE 0.5 DEGREES DIMENSIONS IN BRACKETS [] ARE IN INCHES FOR REFERENCE ONLY
SIZE	(0)	(0.0)	(0.00)																																		
0-10mm	±0.5	±0.15	±0.10																																		
>10-30	±0.5	±0.20	±0.15																																		
>30-50	±0.5	±0.30	±0.20																																		
>50-100	±0.8	±0.50	±0.25																																		
>100-200	±1.5	±0.80	±0.40																																		
>200-300	±2.0	±1.20	±0.80																																		
>300-500	±3.0	±2.00	±1.00																																		
>500	±5.0	±3.00	±1.50																																		

ORG. SCALE: 1:1 CREATE DATE: 12/10/2018

MATERIAL: SEE NOTES

Part ID: 1078908 Project: P020265-1

TITLE:
 QRTN WING KNOB GRPR
 24.5MM

DWG. No. 0622091E

SHEET
 1 of 1
 ISSUE
 1