

CUT OUT

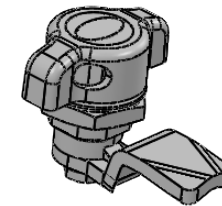

1:2

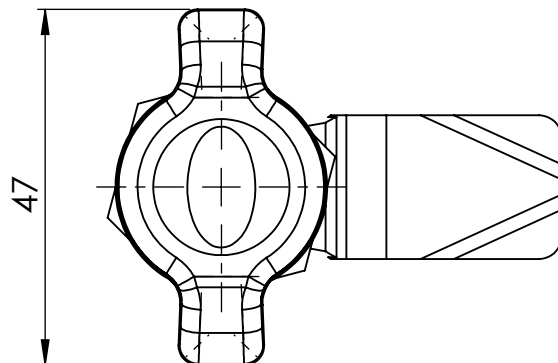

NOTE

MATERIAL
 HOUSING : ZAMAK ZNAL4CU1
 KNOB : ZAMAK ZNAL4CU1
 CAM : STEEL

ACTION : LH
 FINISH : CHROME PLATED

UNLESS OTHERWISE STATED

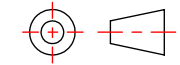
ALL DIMENSIONS IN mm	DO NOT SCALE
LINEAR TOLERANCE	THIRD ANGLE PROJECTION
SIZE (0) (0.0) (0.00)	
0-10mm ±0.5 ±0.15 ±0.10	ANGULAR TOLERANCE ±0.5 DEGREES
>10-30 ±0.5 ±0.20 ±0.15	UNSPECIFIED RADII 0.25mm
>30-50 ±0.5 ±0.30 ±0.20	DRAFT ANGLE 0.5 DEGREES
>50-100 ±0.8 ±0.50 ±0.25	DIMENSIONS IN BRACKETS [] ARE IN INCHES FOR REFERENCE ONLY
>100-200 ±1.5 ±0.80 ±0.40	
>200-300 ±2.0 ±1.20 ±0.80	
>300-500 ±3.0 ±2.00 ±1.00	
>500 ±5.0 ±3.00 ±1.50	

ORG. SCALE: 1:1 CREATE DATE: 03/12/2018

MATERIAL: SEE NOTES

Part ID: 1078889 Project: P020275-1

TITLE:
 QRTN LH WING KNOB GRPR
 8.5MM

DWG. No. 262160002E

SHEET
 1 of 1
 ISSUE
 1

APPROVED - UNCONTROLLED