

CUT OUT

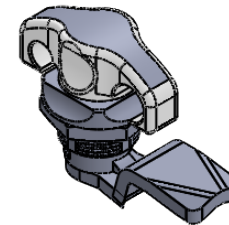

1:2

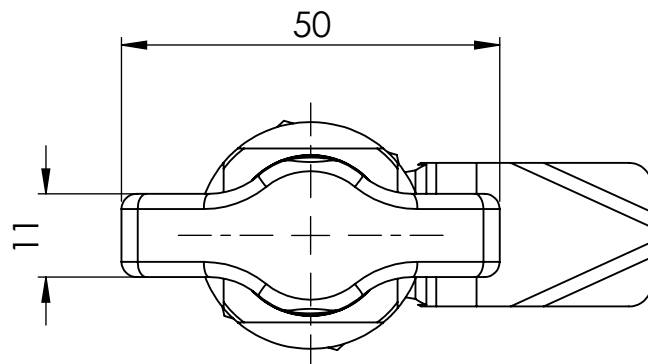

NOTE:

MATERIAL

HOUSING : ZAMAK ZnAl4Cu1

DRIVER : ZAMAK ZnAl4Cu1

CAM : Steel

ACTION : LH/RH

FINISH : BLACK COATED

UNLESS OTHERWISE STATED

ALL DIMENSIONS IN mm

DO NOT SCALE

LINEAR TOLERANCE

SIZE	(0)	(0.0)	(0.00)
0-10mm	±0.5	±0.15	±0.10
>10-30	±0.5	±0.20	±0.15
>30-50	±0.5	±0.30	±0.20
>50-100	±0.8	±0.50	±0.25
>100-200	±1.5	±0.80	±0.40
>200-300	±2.0	±1.20	±0.80
>300-500	±3.0	±2.00	±1.00
>500	±5.0	±3.00	±1.50

THIRD ANGLE PROJECTION

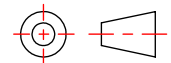

ANGULAR TOLERANCE ±0.5 DEGREES
 UNSPECIFIED RADII 0.25mm
 DRAFT ANGLE 0.5 DEGREES
 DIMENSIONS IN BRACKETS [] ARE
 IN INCHES FOR REFERENCE ONLY

ORG. SCALE: 1:1

CREATE DATE: 25/09/2017

MATERIAL: SEE NOTES

Part ID: 1336481

Project: P020275-1

TITLE:
 PADLOCKABLE BLACK
 ZAMAK LOCK WING KNOB

DWG. No.

562260E

SHEET
 1 of 1
 ISSUE
 1

AWAITING APPROVAL