

© THIS DRAWING IS THE EXCLUSIVE PROPERTY OF MARQUARDT. WITHOUT THEIR CONSENT IT MAY NOT BE REPRODUCED OR GIVEN TO THIRD PARTIES.

CONFIDENTIAL

VERTRAULICH

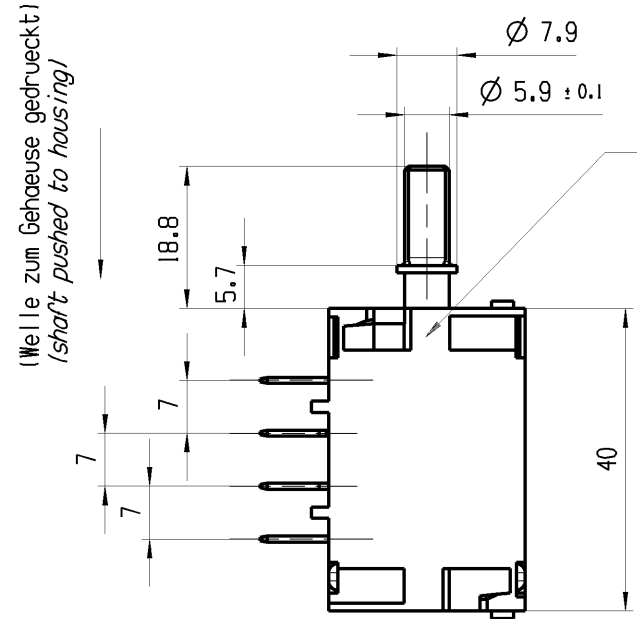

Aufschrift C
(Seite beliebig)
marking C
(side optional)

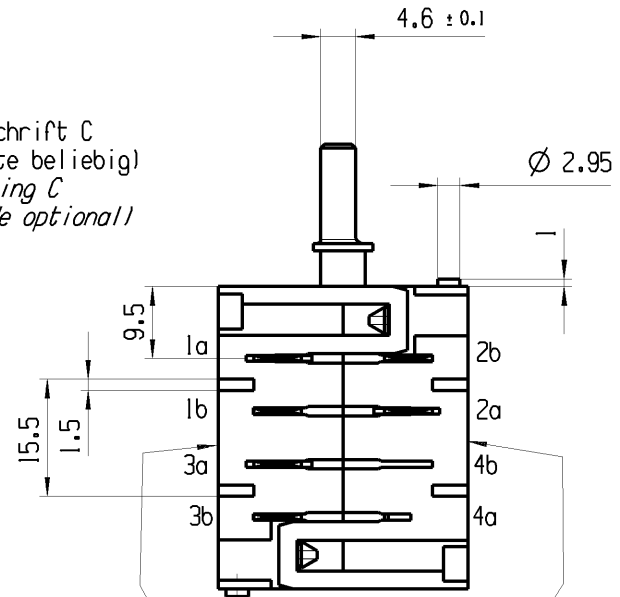

Aufschrift A
marking A

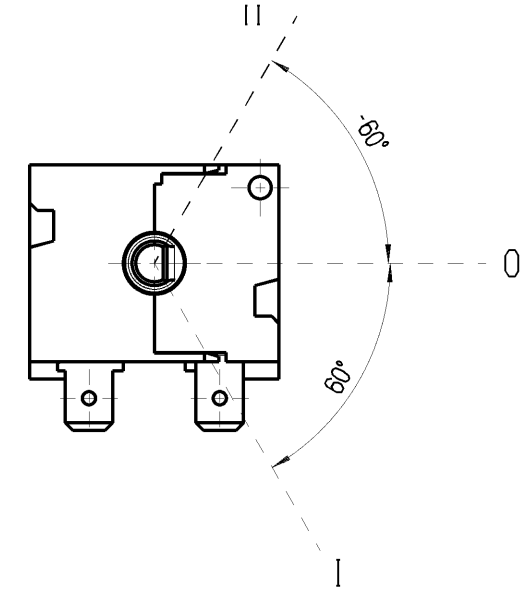

Welle in Position 0 gezeichnet
shaft shown in position 0

Position position	Winkel° angle°	Verbindung zwischen Anschlüssen connection between terminals			
		1a/1b	2a/b	3a/3b	4a/4b
II	-60°		○	○	
0	0°				
I	60°	○			

Endschlag bei -70° ± 4° und 70° ± 4°
end stop at -70° ± 4° and 70° ± 4°

Betaetigungsmoment ca. 35 Ncm
actuating torque approx. 35 Ncm

Aufschrift A eingespritzt:
marking A injected:

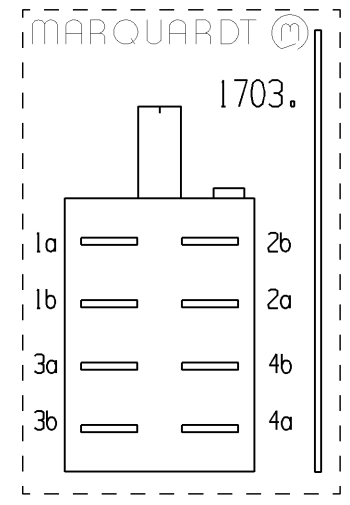

Aufschrift B
(Seite beliebig)
marking B
(side optional)

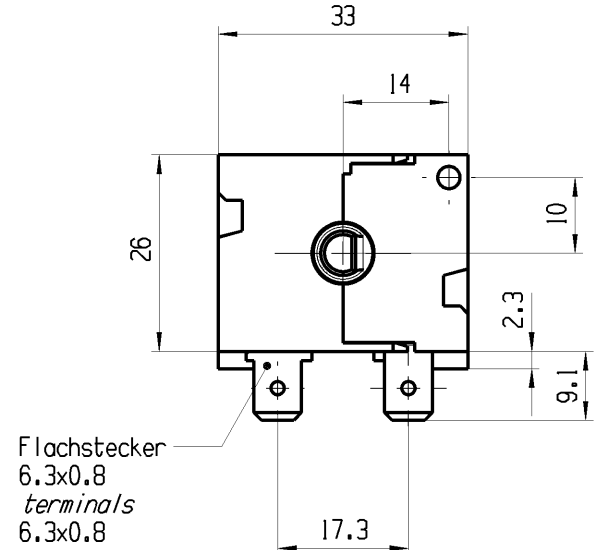

Flachstecker
6.3x0.8
terminals
6.3x0.8

(Gehäuse zusammengedrueckt)
(housings pressed together)

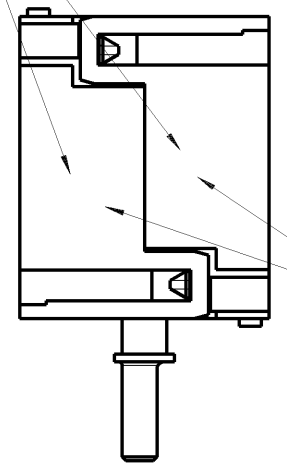

Aufschrift D
(Seite beliebig)
marking D
(side optional)

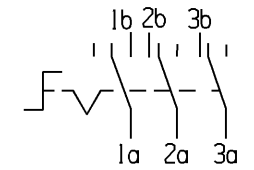

Drehschalter 3-polig
Fuer Gerate der Klasse II geeignet

Rotary Switch 3 pole
suitable for appliances of class II

Aufschrift B bedruckt:
marking B printed:

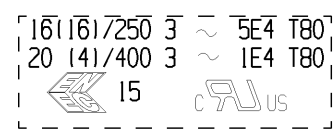

Aufschrift C gepraegt:
marking C stamped:

Herstellort -jahr/-woche (TJYWW)
code of manufacture: place/year/week (Tyyww)

Aufschrift D bedruckt:
marking D printed:

6506230

Aufschrift auf Verpackung:
marking on box:
6506230

Lieferzustand immer in Aus-Stellung
delivery condition always in OFF-position

Fuer Form und Lage FOR SHAPE AND LOC.	PROJEKTION	Allgemeintoleranzen UNTOLERANCED DIMENSIONS				Pause COPY	Blatt SHEET 01	TYP K	Zeichn./DRAWING NO. 17034101	Index c
		Abmasse und Nennmassbereiche Angaben in mm	Laenge LENGTH	Radien RADII	SCALE					
Fuer Winkel FOR ANGLE ± 2	PROJEKTION	0-6 ± 0.15	7-15 ± 0.2	15-30 ± 0.25	30-70 ± 0.4	70-120 ± 1.0	Original Din A3	Mossstab SCALE 1:1 30mm	GERAETESCHALTER appliance switch	
c	96138	02.06.15	HHE				CAD: NX V8.5		Ersatz fuer/REPLACEMENT OF V07197110	
b	95219	06.05.15	HHE				gez./DRAWN BY 23.01.09 BRC			
a	73385	01.06.11	MUT				gepr./CHECKED BY			
Ausg. ISSUE	Aenderung REVISION	gez. DRAWN BY	Ausg. ISSUE	Aenderung REVISION	gez. DRAWN BY	Ersatz fuer/REPLACEMENT OF V07197110		MARQUARDT		

© Alle Rechte bei Marquardt, auch fuer den Fall von Schutzrechtsmeldungen. Jede Veruegungsbefugnis, wie Kopier- und Weitergaberecht, bei uns.