

# **MITSUBISHI ELECTRIC**

## **E-Designer for the E1000-series**

---

**Reference Manual**

## Manual for E-Designer

# Foreword

This manual is a description of E-Designer, the configuration tool used to create applications for the operator panels in the E1000-series. Further on in the manual we refer to the configuration tool.

Please see the E-Designer User's Guide (MA00760) for function-based descriptions.

The manual assumes that the most recent versions of the system program (firmware) and configuration tool are used.

The configuration tool can also be used to create and edit projects for the operator panels in the E-series. Programming of the operator panels in the E-series is described in the manual MA00552D.

For specific controller details and the connected controller, we refer to the driver help file for the respective controller. The functionality in the operator panels is the same, regardless of which controller is connected to the operator panel.

The operator panel can be connected to many types of automation equipment, such as PLCs, servo and drives. In this document the expression "the controller" is used as a general term for the connected equipment.

© Mitsubishi Electric, MA00759F, 2008-07

The information in this document is subject to change without notice and is provided as available at the time of printing. The manufacturer reserves the right to change any information without updating this publication. The manufacturer assumes no responsibility for any errors that may appear in this document.

All examples in this document are only intended to improve understanding of the functionality and handling of the equipment. The manufacturer cannot assume any liability if these examples are used in real applications.

In view of the wide range of applications for this software, users must acquire sufficient knowledge themselves in order to ensure that it is correctly used in their specific application. Persons responsible for the application and the equipment must themselves ensure that each application is in compliance with all relevant requirements, standards and legislation in respect to configuration and safety.

The manufacturer will accept no liability for any damage incurred during the installation or use of any equipment mentioned in this document.

# Contents

<b>1</b>	<b>Installation .....</b>	<b>9</b>
1.1	The Configuration Tool.....	9
<b>2</b>	<b>General.....</b>	<b>11</b>
2.1	Method for Creating a Project.....	11
2.2	Blocks.....	12
2.3	Signal Format.....	13
2.4	Efficient Communication.....	14
2.5	Performance in the Operator Panel .....	16
2.6	Project Documentation .....	17
2.7	Service Menu.....	18
2.8	Diagnostic Page.....	20
<b>3</b>	<b>Configuration with the Configuration Tool .....</b>	<b>21</b>
3.1	Starting the Configuration Tool .....	22
3.2	Selecting Menu Language.....	22
3.3	Creating a Project.....	23
3.4	Saving a Project .....	27
3.5	Updating Drivers.....	27
3.6	Changing Project Properties .....	28
3.7	The Project Manager .....	29
3.8	The Block Manager .....	31
3.9	Showing Operator Panel around the Working Area.....	36
3.10	Configuration of Blocks .....	37
3.11	Using Text Blocks .....	41
3.12	Static Symbols .....	42
3.13	Changing I/Os .....	46
3.14	The I/O Browser .....	47
3.15	Changing BDTP Station .....	48

3.16	I/O Cross Reference.....	49
3.17	Other Managers/Editors .....	49
3.18	The File Menu.....	50
3.19	The Edit Menu.....	53
3.20	The View Menu.....	54
3.21	The Functions Menu .....	58
3.22	The Setup Menu.....	60
3.23	The Block Manager menu .....	74
3.24	The Object menu .....	75
3.25	The Layout Menu.....	76
3.26	The Project Menu.....	76
3.27	The Transfer Menu .....	77
3.28	The Window Menu.....	77
3.29	The Help Menu.....	77
<b>4</b>	<b>Graphic Presentation and Maneuvering.....</b>	<b>79</b>
4.1	General Parameters .....	79
4.2	Graphic Objects.....	88
4.3	Maneuvering Graphic Blocks Using the Key Pad.....	123
4.4	Maneuvering Objects Using the Touch Screen .....	126
<b>5</b>	<b>Text-based Presentation for Printouts and Reports .....</b>	<b>129</b>
5.1	General Parameters .....	129
5.2	Text Objects .....	131
<b>6</b>	<b>Trends.....</b>	<b>139</b>
6.1	Historical Trend .....	140
6.2	Defining Trend Objects.....	141
6.3	Transfer of Trend Data.....	145
6.4	Backup of Trend Data .....	147
<b>7</b>	<b>Message Library.....</b>	<b>149</b>

<b>8 Alarm Management</b> .....	<b>153</b>
8.1 Alarm Groups.....	154
8.2 Alarms.....	155
8.3 Alarm Properties.....	159
8.4 Alarm Import .....	161
8.5 Alarm Banner .....	162
8.6 Alarms in the Operator Panel .....	164
8.7 Alarm Backup.....	166
8.8 Graphic Alarm Page .....	168
<b>9 Recipes</b> .....	<b>169</b>
9.1 Calculation of Recipe Size .....	170
9.2 Recipe Properties and Recipe Directory.....	171
9.3 Creating a Recipe with the Operator Panel.....	173
9.4 Appending Recipes .....	174
9.5 Transferring Recipes to the Controller.....	175
9.6 Deleting Recipes.....	175
9.7 Using Recipes in a PC .....	175
9.8 Creating and Transferring Recipes with the Controller Program .....	176
9.9 Saving Individual Recipes on External Memory Card in Runtime .....	180
<b>10 Data Logger</b> .....	<b>183</b>
<b>11 Passwords</b> .....	<b>185</b>
11.1 Defining Security Levels .....	185
11.2 Defining Passwords .....	186
11.3 Logging in .....	187
11.4 Password for Project Transfer .....	187
11.5 Overriding Password .....	188
11.6 Changing Password in the Operator Panel .....	188
11.7 Password Handling via USB Flash Drive .....	188

<b>12 Printouts from the Operator Panel</b> .....	<b>189</b>
12.1 Connection to Printer.....	189
12.2 Text Block Reports .....	190
12.3 Graphic Block Printouts .....	190
12.4 Defining the Printout .....	191
12.5 Printer Properties.....	192
12.6 Control Codes to Printer .....	193
<b>13 Time Channels</b> .....	<b>195</b>
13.1 Defining Time Channels .....	195
13.2 Presentation in the Operator Panel .....	196
<b>14 Language Management</b> .....	<b>197</b>
14.1 Unicode in the Operator Panel .....	197
14.2 Creating Additional Application Languages .....	198
14.3 Translating/Editing Texts in the Configuration Tool .....	200
14.4 Properties for the Application Language .....	201
14.5 Export.....	203
14.6 Import .....	203
14.7 Show Index.....	203
14.8 Cross Reference .....	203
14.9 Reuse Index .....	204
14.10 Font Templates.....	205
14.11 Unicode in E1012 and E1022 .....	206
<b>15 System Monitor</b> .....	<b>209</b>
<b>16 Index Addressing</b> .....	<b>211</b>

<b>17 Communication .....</b>	<b>215</b>
17.1 Communication with Two Controllers (Dual Drivers).....	215
17.2 Data Exchange between Controllers .....	219
17.3 Transparent Mode.....	221
17.4 Passthrough Mode.....	225
17.5 The Operator Panel as a Communication Interface (No Protocol Mode).....	227
17.6 Modem Connection .....	231
<b>18 Network Communication.....</b>	<b>235</b>
18.1 Examples of Possible Networks.....	236
18.2 Network Communication through Ethernet .....	240
18.3 Serial Network Communication/PPP .....	244
18.4 Network Services .....	250
18.5 Network Accounts.....	267
18.6 Recommendations and Limitations for Network Communication ..	268
18.7 Obtaining the MAC Address during Runtime.....	270
<b>19 Network Functions in the Operator Panel.....</b>	<b>271</b>
19.1 FTP Server .....	271
19.2 SMTP Client.....	276
19.3 Web Server.....	277
<b>20 LEDs .....</b>	<b>287</b>
<b>21 Function Keys.....</b>	<b>289</b>
21.1 Definitions .....	290
21.2 Jump to Block with Function Keys.....	293
21.3 Joystick Function .....	294
21.4 Extended Function Keyboard .....	295
<b>22 Macros.....</b>	<b>297</b>

<b>23 Project Transfer</b> .....	<b>301</b>
23.1 Transfer Properties.....	301
23.2 TCP/IP Transfer.....	305
23.3 Serial Transfer.....	306
23.4 Modem Transfer.....	306
23.5 Transfer to/from External Memory Card.....	309
<b>24 Transfer of Controller Program and Parameters</b> .....	<b>311</b>
24.1 Transferring Controller Software to USB Flash Drive (Upload).....	311
24.2 Transferring Controller Software from USB Flash Drive (Download)	312
<b>25 Updating the Operator Panel</b> .....	<b>313</b>
25.1 Downloading the System Program via PC .....	313
25.2 Downloading the System Program via External Memory Card .....	314
25.3 Downloading the System Program in E1012 and E1022 .....	315



# 1 Installation

## 1.1 The Configuration Tool

The configuration tool is a software package used for developing projects for operator panels in the E1000-series. The functions in the configuration tool depend on which operator panel model is used.

In the configuration tool a project is created with graphic blocks and text blocks, which are then transferred to the operator panel. The configuration is described in the chapter *Configuration with the Configuration Tool*.

Help texts are available for all functions. The help text for the current function is displayed by pressing the F1 key. By clicking the help button in the toolbar and then clicking on a function, information is shown about that function.

### System Requirements

To use the configuration tool, a PC with at least 100 MB of available memory and Microsoft Windows 2000/XP Professional is required. The configuration tool can be used on either a color or monochrome screen. Microsoft Internet Explorer version 5.0 or later must be installed on the computer.

### Installing the Configuration Tool

The configuration tool is supplied on a CD. When placing the CD in the CD-ROM drive, the installation will start automatically. If not, select **Run** on the **Start** menu and enter D:\setup.exe (if D: is the CD-ROM drive). Select to install the configuration tool by clicking on the name and following the instructions.

The installation creates an icon for the configuration tool in the E-Designer group. Clicking **Start** and selecting **All Programs/E-Designer/E-Designer** starts the configuration tool.



## 2 General

This chapter describes the structure of an application project in the operator panel. There is also an explanation of the general principles, object parameters, and joint functions applicable in the operator panel.

### 2.1 Method for Creating a Project

The graphical structure of the application in the operator panel constitutes a well-arranged monitoring tool for the operator. It is important to organize the application well and to consider which functions are necessary. Start with the overall view, and then work down to the detailed level.

The application is built up of blocks, graphic blocks and/or text blocks. Values from the controller are shown and changed in the blocks. Each function becomes one or more blocks, depending on how complex the function is. A project can contain both graphic and text blocks, and each block can contain static and dynamic objects. The blocks should be arranged in hierarchies to achieve a structured application, and to simplify work procedures for the machine operator. The application can also be organized as sequence controls.

It is possible to test the complete application, or parts of it, before it is downloaded to the operator panel.

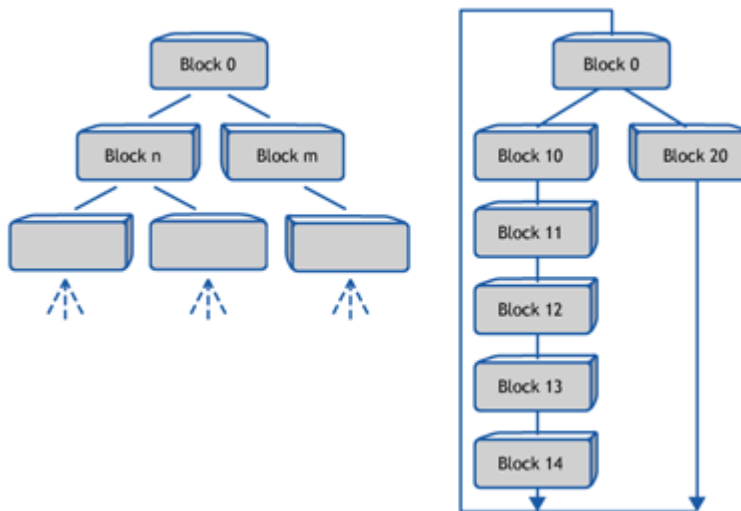

## 2.2 Blocks

Each block has a number between 0 and 989 allocated by the developer. The blocks 990-999 are reserved for special purposes, so-called system blocks. The operator panel is object-orientated, which means that a block can contain all the signals linked to an object for the control and monitoring of, for example, a pump.

Block properties, such as block number and type of block, are defined for each block.

The functions Alarms, Time channels, System Monitor, E-mail and Contrast Properties can also be invoked as blocks. These are designated system blocks. Text blocks are used for report printouts and e-mail, and cannot be displayed to the operator, except when using E1012, E1022 and 1032. The maximum number of blocks in a project is 990.

---

**Note:**

The block type cannot be changed for a defined block.

---

## 2.3 Signal Format

The following signal formats are available in the dialog for each object, on the assumption that the selected driver supports the signal format.

Format type	Area
Signed 16-bit	-32,768 - +32,767
Unsigned 16-bit	0 - +65,535
Signed 32-bit	-2147483648 - +2147483647*
Unsigned 32-bit	0 - +4294967295*
Float with exponent, 32-bit	$\pm 3.4E38^*$ . Numbers larger than 1,000,000 are shown with exponent.
Float without exponent, 32-bit	Parameters Positions (including decimal point and characters) and Decimals indicate the available area*. E.g. 8 positions and 3 decimals result in $\pm 999.999$ .
BCD Float	0 - 9999,9999.
BCD 16-bit	0 - 9999
BCD 32-bit	0 - 99999999*
HEX 16-bit	0 - FFFF
HEX 32-bit	0 - FFFF FFFF*
Seconds 16-bit	The object Analog numeric can present the time format. Syntax: <hours:minutes:seconds>. Example: The register value in D0=3661, the object Analog numeric linked to D0 and defined as Seconds 16-bit will then show <1:01:01>.
Seconds 32-bit	The object Analog numeric can present the time format*. Syntax: <hours:minutes:seconds>.
String	Character string which can be used in the dynamic function for graphic objects. Example: In the object Static symbol, Digital symbol and Multiple symbol, the dynamic property Symbol can be linked to a register with the format String.
Array 16-bit	Table format which can be used for an Event in the dynamic function for graphic objects. Example: A group of registers is to be allocated different values when "Value entered" is equal to 99. The first value in the field Value will then be entered to register D21 in the field Signal. If the field Value appears as follows, <1,2,3,4> the value 2 will be entered in next subsequent register (D22), etc.

\* Values in 32-bit format will contain some inexactness, since both the configuration tool and the operator panel handles only the first 6 digits of a 32-bit value. The remaining digits will be truncated or changed into zeroes.

## 2.4 Efficient Communication

To make the communication between the operator panel and the controller quick and efficient the following should be noted about how the signals are read and how the reading can be optimized.

### Signals Affecting Communication Time

Only signals to objects in the current block are read continuously. This also includes signals for object dynamics. Signals to objects in other blocks are not read, thus the number of blocks does not affect the communication time.

Besides the signals to objects in the current block, the operator panel reads the following signals from the controller continuously:

Display signals (Block Properties)

Print signals (Block Properties)

LED registers

Alarm signals

Remote acknowledge signals on alarms and alarm groups

Login signal (Passwords)

Logout signal (Passwords)

Registers for trend curves

Bar graph registers if using min/max indicators

New display register

Buzzer register

Backlight signal

Cursor control block

Recipe control block

Library index register

Index Registers

Controller clock register if the controller clock is used in the operator panel

List erase signal (Alarm Properties)

No protocol control register

No protocol on signal

### Signals not Affecting the Communication Time

The following signals do not affect the communication time:

- Signals linked to function keys
- Time channels
- Objects in the alarm messages

## How to Make the Communication More Efficient

### Group Controller Signals Consecutively

Signals from the controller are read most rapidly if all signals in the list above are consecutive. If for example, 100 signals are defined, the quickest way to read these is to link them, for example, M0.0-M11.7. If the signals are spread (e.g. I0.4, Q30.0, M45.3 etc.) the updating is slower.

### Efficient Block Changes

Block changes are carried out most rapidly and efficiently through the block jump function on the function keys or through a jump object. **Display** signals in block properties should only be used when the controller is to force the presentation of another block. The **New display** register can also be used if the controller is to change the block. This does not affect communication as much as a larger number of **Display** signals.

### Use the Clock in the Operator Panel

An extra load is put on communication if the clock in the controller system is used, since the clock register must be read up to the operator panel. Downloading of the clock to the controller also creates an extra load. The interval between downloads should therefore be as long as possible.

### Packaging of Signals

When signals are to be transferred between the operator panel and controller, they are not all transferred at the same time. They are divided into packages, each containing a number of signals, instead. The number of signals in each package depends on which driver is used.

To make communication as fast as possible the number of packages has to be minimized. Consecutive signals require a minimum number of packages, but it is perhaps not always possible to program it this way. In such cases there is a “waste” between two signals. This gap in the maximum distance between two signals which can still be kept in the same package. The size of the gap depends on which driver is used.

Signal	1	2	3	4	5	6	7	8	9	10
Used	X	X					X	X	X	

  
Waste

## 2.5 Performance in the Operator Panel

In addition to the efficient communication chapter, it is very important to understand that the following (amongst other) will affect the performance of the panel:

- Number of signals
- Number of pens in trends and data logger
- Number of alarms
- Consecutive order of signals
- Driver performance
- Dual driver
- Type of panel
- Alarm list size
- Store all samples/ changed samples
- Sample interval
- Controller clock
- Large bitmaps
- VNC and other remote tools
- Poll groups
- Station handling
- Data exchange



## 2.6 Project Documentation

### Project Printouts

Select **File/Print...** to print the project.

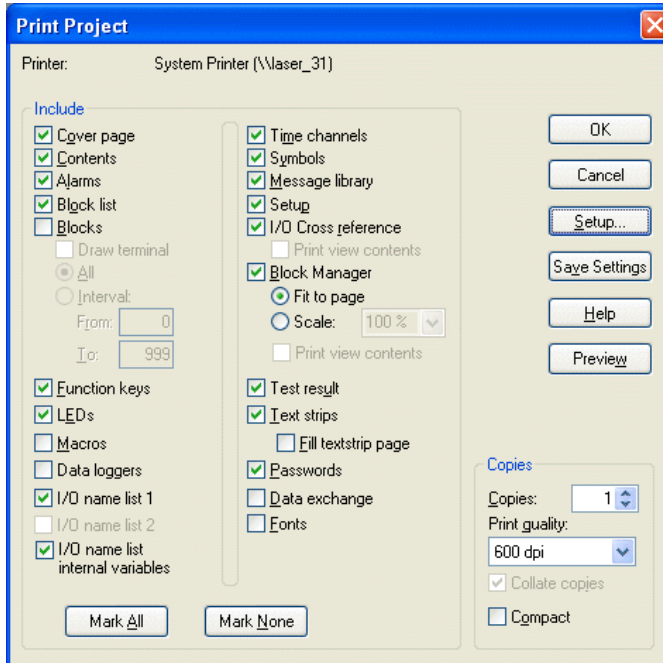

The project documentation is generated automatically by selecting the options in the Print Project dialog. Choose which parts to include by clicking the boxes. The project documentation can include a table of contents and a cover page (Document Header) with the option to include the desired logo and text. Select **File/Document Header** to define the contents. Click **Preview** to view the printout before sending it to the printer. Select **Setup** to configure the printer.

## 2.7 Service Menu

The Service Menu is accessed by setting the mode switches on the operator panel in mode 1000. Please see the Hardware and Installation manual for the operator panel for information about the mode switches.

The following options are available in the Service Menu:

### Network Settings

Select this option to access the Network Menu.

#### Network Menu

The options in the Network Menu corresponds to selecting **Settings/Network** in E-Designer and contains the following items:

Menu item	Described in
TCP/IP Settings	<a href="#">18.2 Network Communication through Ethernet</a>
Accounts	<a href="#">18.5 Network Accounts</a>
Services	<a href="#">18.4 Network Services</a>

### Erase Project Memory

This option erases the project memory.

### Load Project from Memory Card

An empty operator panel can be started with an existing E-Designer project, used in another panel. The project first has to be saved to a Compact Flash memory card or USB memory stick via the function **Save project to memory card** (for example via a function key).

Insert the memory card in the empty panel before boot-up. Then select **Load project from memory card** in the service menu and follow the instructions.

### Enter Transfer Mode

Allows entering transfer mode manually, needed to download projects via GSM modem. See section [Transfer via GSM Modem](#) for details.

### Enter Run Mode

Allows entering run mode manually, needed to download projects via GSM modem. See section [Transfer via GSM Modem](#) for details.

## **Update System Program from Memory Card**

Insert a Compact Flash or USB memory stick with a new system program and follow the instructions. The system program can also be updated via the configuration tool for the operator panels.

## **Calibrate Touch Screen**

Follow the instructions on the screen to calibrate the touch screen.

## 2.8 Diagnostic Page

The diagnostic page is accessed by pressing a key or a touch key that has been configured for this purpose. See chapter [21 Function Keys](#).

The diagnostic page displays the following information:

```
E1070 U1.31 B122, Built Apr 17 2007 15:42:56
STARTS, RUN, CFL: 2, 0h, 0h

DYNAMIC MEMORY: 19312 KB FREE
FLASH MEM PROJ: 667 KB USED
FLASH MEM BACK: 0 KB USED
BLOCK UPDATE (ms): 1511

Driver 1 : DEMO 4.01.00
Poll group interval (ms) : 25 - - - Total
Static digital IO count : 0 - - - 0
Static analog IO count : 0 - - - 0
Static poll time (ms) : - - - -
Monitor digital IO count : 0 - - - 0
Monitor analog IO count : 0 - - - 0
Monitor poll time (ms) : - - - -
Timeouts : 0
Checksum errors : 0

COM1 FRAME, OVERRUN, PARITY: 0, 0, 0
COM2 FRAME, OVERRUN, PARITY: 0, 0, 0
```

Row	Contents
1	Information about the operator panel, panel version and when the version was built
2	Number of times the panel has been started, hours running, hours of backlight ON
3	Amount of free dynamic memory
4	Size of the project (in the flash memory). Only displayed if the PSCE command is used - see section <a href="#">Commands</a> . Using the command in projects with a large number of trend curves will considerably slow down loading the diagnostic page.
5	If a Compact Flash or USB memory card is used
6	Time in ms that it takes to draw/update the complete block
7	Driver information (name and version)
8	The different poll groups declared in the project (in this case Poll group 1 = 25 ms)
9	Number of static digital signals that are read
10	Number of static analog signals that are read
11	Poll time for all static signals (both digital and analog)
12	Number of digital signals that are monitored in the current block
13	Number of analog signals that are monitored in the current block
14	Poll time for all monitored signals in the current block
15	Number of timeouts in the communication
16	Number of checksum errors in the communication
17	Information about communication problems
18	Information about communication problems

**Note:**

Not all operator panel models display all the information above.

### 3 Configuration with the Configuration Tool

This chapter describes how to configure the operator panel using the configuration tool. How to install the software is explained in the chapter *Installation*.

The configuration can be performed using the menus, additionally, many functions can be reached easily by right-clicking on a component in the Project Manager or from different toolbars. Select **View/Toolbars** to display or hide different toolbars.

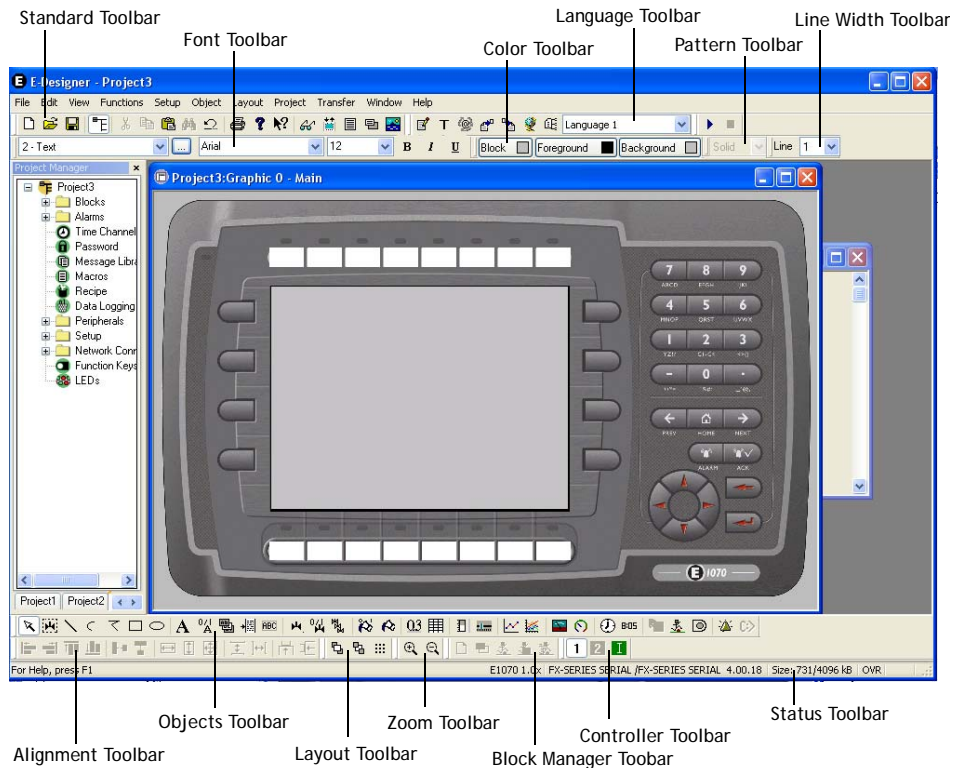

*Toolbars in the configuration tool.*

## 3.1 Starting the Configuration Tool

Click on **Start/All Programs/E-Designer/E-Designer**.

The menus **File**, **View**, **Properties** and **Help** are displayed in the menu bar when the configuration tool is started.

### The Standard Toolbar



The **Standard Toolbar** is used for functions such as opening and saving projects, copying and pasting objects, and undoing the latest actions. One button is used to display/hide the Project Manager, and another to print the current project. See chapter [Printouts from the Operator Panel](#) for further information. It is also possible to display the relevant help topic for a selected object or menu alternative by clicking the  button, and then clicking on an object or menu alternative in the configuration tool.

## 3.2 Selecting Menu Language

Select in which language to present the configuration tool under **Settings/Menu language**. This language will be used for menu texts, object names etc. In this manual we assume that **English** has been selected.

### 3.3 Creating a Project

A new project is created under **File/New**. Select the type of operator panel and controller to use in the project in the **Project Properties** dialog. All the alternatives are not available for every type of operator panel. Click **OK** to create a new project.

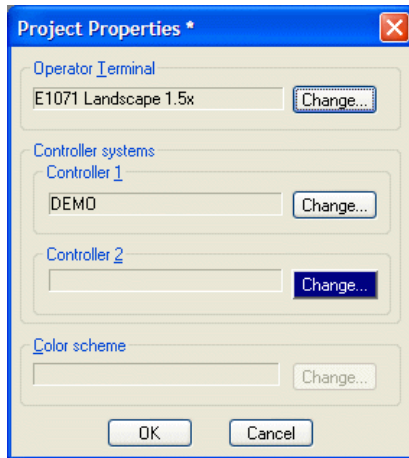

Click **Change**.

#### Operator Terminal

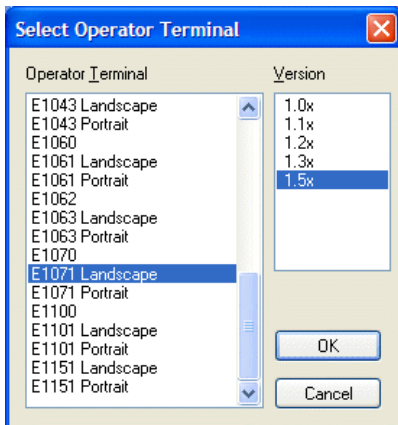

Select operator panel model and version (system program) for the operator panel used.

## Controller Systems

Select the controller the operator panel is to be connected to. Click the **Change** button to display the list of installed drivers. Select brand name and protocol. Click **OK** to finish. If you do not want to make any changes, click **Cancel**.

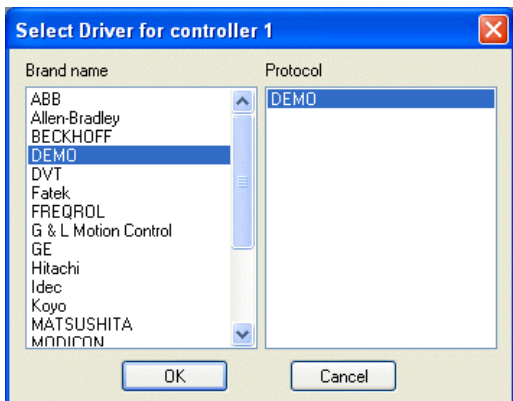

Two drivers can be used in the same project, i.e. the operator panel is capable of using two drivers. The driver for the second controller is selected in the same way as for the first. For further information about using two drivers in the project, see the section [Communication with Two Controllers \(Dual Drivers\)](#) in the chapter [Communication](#).

When selecting a protocol that can be used by several controller models, the model is chosen by right-clicking on the protocol in the **Peripherals** dialog, and selecting **Properties**.

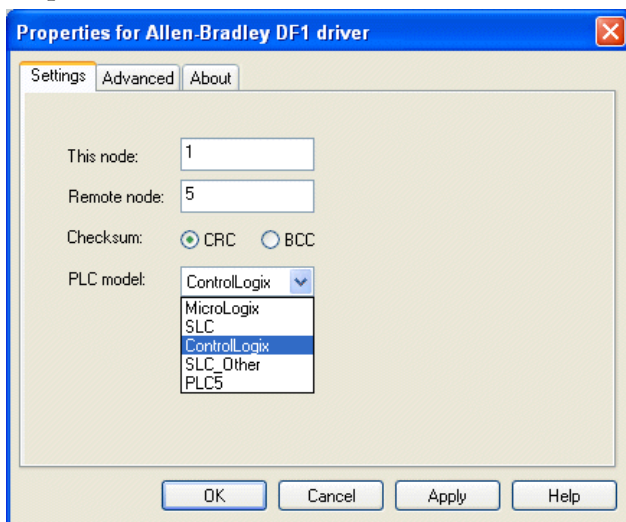



## Internal Variables

Internal variables can be used and selected in the same way as different drivers. A number of volatile and non-volatile user-defined variables can be selected. When a value is changed, the non-volatile variables are saved in the flash memory to be read at the next start-up. The system variables are fixed. These can be used to display e.g. poll intervals and for toggle functions. By clicking **Properties & Help** in the **I/O Browser** or selecting **Functions /I/O Configuration/Internal Variables** the following window is displayed.

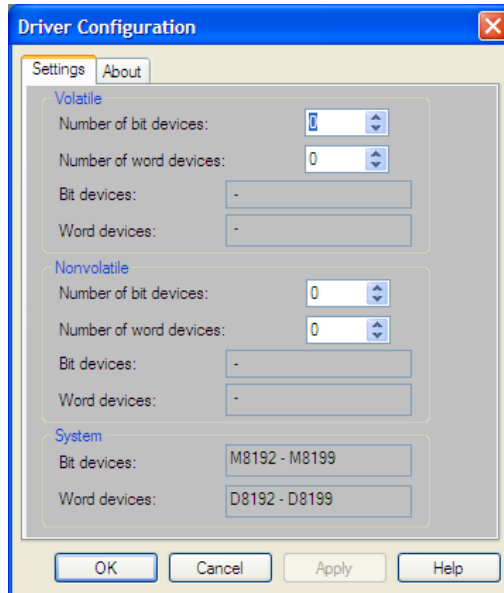

Variable type	Addressing area, bit	Addressing area, memory cell
Volatile	M0 - M4095	D0 - D4095
Non-volatile	M4096 - M8191	D4096 - D8191
System	M8192 - M8199	D8192 - D8199

The system variables are used according to the tables below:

Bit	Description
M8192	Always ON
M8193	Toggles between OFF and ON every second
M8194	Toggles between OFF and ON every 500 ms
M8195	Toggles between OFF and ON every 200 ms

Bit	Description
M8196	Communication Error bit for driver 1. The value 0 indicates a communication error. Not valid for slave drivers.
M8197	Communication Error bit for driver 2. The value 0 indicates a communication error. Not valid for slave drivers.
M8198- M8199	Not used

Memory cell	Description
D8192	Displays poll interval of connected Controller 1 (ms)
D8193	Displays poll interval of connected Controller 2 (ms)
D8194 - D8199	Not used

The internal variables will use a total of approximately 20 KB of memory in the operator panel. Unlike the regular drivers, it does not matter if internal variables are used in consecutive order or not.

## The Controller Toolbar



The driver for a selected object can be selected from the **Controller Toolbar**. Using internal variables is selected by clicking the I-symbol.

## Color Scheme

In the E-series operator panels color schemes can be created to determine the color of the background, menus, dialogs, and objects, etc. This is not supported in the E1000 panels.

Once a project is opened or created, the Project Manager is displayed, containing all components included in the current project. Functions in the project can be added and edited from the Project Manager, from different toolbars or from menus.

## The Status Bar



The **Status bar** is shown at the bottom of the window in the configuration tool.

The left part of the status bar describes the function of the selected menu, or presents a short description of the object that the cursor points at in the toolbar. The coordinates, line and column in the block manager, are also shown.

The right part of the status bar displays operator panel model and driver version in the current project, and how much memory is available in the operator panel once the project is transferred. **OVR** indicates that the **Insert** key (overwrite) is activated.

## 3.4 Saving a Project

Selecting **File/Save As** allows saving the project either as a regular project with a number of folders, or as a zipped file. A zipped project does not need to be unzipped before it is opened.

## 3.5 Updating Drivers

Drivers can be updated from the Internet or from disk. To implement the downloaded drivers, the configuration tool must be restarted.

### Updating Drivers from the Internet

Select **File/Update Drivers From/Internet** to update available drivers to the latest version, or to install new drivers. The computer has to have access to the Internet, but a web browser is not required. A list of all drivers that can be downloaded from the Internet is displayed when the connection is established.

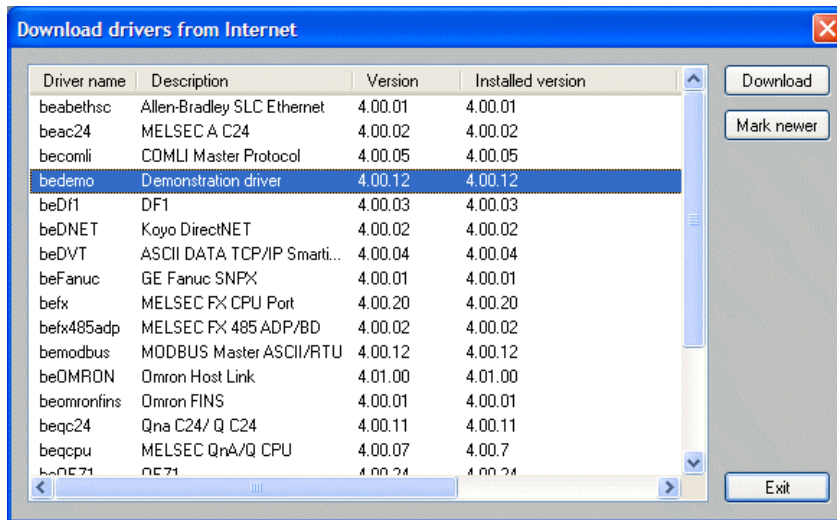

The list shows the version number of the available drivers and the version number of the installed drivers. Select which driver(s) to install in the configuration tool. The function **Mark newer** selects all drivers available in newer versions than the ones installed, including all drivers that are not installed. Click **Download**. Each driver takes up approximately 500 kB and can be used as soon as downloading is complete.

## Updating Drivers from Disk

Select **File/Update Drivers From/Disk** to update available drivers to the latest version, or to install new drivers from disk. Browse to the folder where the driver files are located. A list of all drivers that can be installed is now shown. Then follow the instructions above.

## 3.6 Changing Project Properties

Both the selected operator panel and controller can be changed for the project. Double-click on the project name in the Project Manager to display the Project Properties dialog. Click **Change** for the parameter **Operator Terminal** and/or **Controller systems**.

### Changing Operator Panel Version

If the system program in the operator panel is updated to a newer version, the operator panel version in the **Project Properties** dialog has to be changed also. Otherwise, the new functionality in the new operator panel version cannot be utilized.

### Changing Controller

If the controller in the project is changed to a system with another name for the signals used, these must be changed. This is easily done by using the internal name list. See the section *The Name List*.

1. Select **View/Name List**.
2. Click on the button **Undefined** to insert all I/Os used in the project in the name list.
3. Click on the button **Export** to export the name list to a text file. Enter a name and click **Save**. Define how the text file is to be separated.
4. Open the text file in a text editor, e.g. Wordpad.
5. Change all I/Os to signals used in the new controller, and save the file as a text file.
6. Double-click on the project name in the Project Manager to display the Project Properties dialog. Click **Change** for **Controller**.
7. Select the new controller to be used and click **OK** twice.
8. Click on the button **Import** in the dialog Name list, and click **No** to the question if invalid I/Os should be removed.
9. Click on the **Rebind** button to update all new I/Os in the project with the new names.

## 3.7 The Project Manager

When a project is created, the Project Manager is displayed, with all blocks and components included in the application. Expand the folders in the Project Manager, by clicking on the +, to display the contents of the folders.

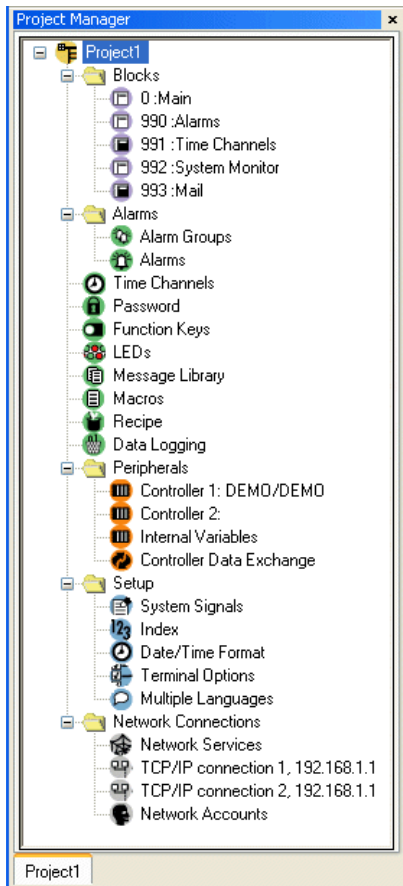

### The Blocks Folder

Some blocks in the **Blocks** folder are created automatically. The **Main** block, block 0, must always be used in the project. The system blocks **Alarms**, **Time Channels**, **System Monitor** and **Mail** cannot be deleted. A new block can be created by right-clicking on the folder and selecting **New**. Double-clicking on the **Blocks** folder displays *The Block Manager*.

## The Alarms Folder

**Alarm Groups** and **Alarm Messages** are automatically created in the **Alarms** folder. See chapter *Alarm Management* for information.

## The Peripherals Folder

Right-click on **Controller 1** or **Controller 2** to select another driver, to change the port the controller is connected to or to display the controller properties. See also section *Controller Systems*.

Right-click on **Internal Variables** and select **Properties** to display the Internal Variables properties. See also section *Internal Variables*.

**Controller Data Exchange** is described in section *Data Exchange between Controllers*.

## The Setup Folder

Properties for the operator panel can be made from the **Setup** folder.

See sections *System Signals*, *Index Addressing*, *Country/Language*, *Date/Time Format* (for **Clock Properties**), *Terminal Options* and *Multiple Languages* for information.

## The Network Folder

The properties that can be made under the **Network** folder are described in the sections *Network Services*, *Network Communication through Ethernet* (**TCP/IP Connection 1** and **TCP/IP Connection 2**) and *Network Accounts*.

## Other Project Manager Components

The functions *Time Channels*, *Passwords*, *Function Keys*, *LEDs*, *Message Library*, *Macros* and *Recipes* are described in separate chapters.

## 3.8 The Block Manager

Double-clicking on the **Blocks** folder displays the Block Manager, with an overview of all blocks in the project.

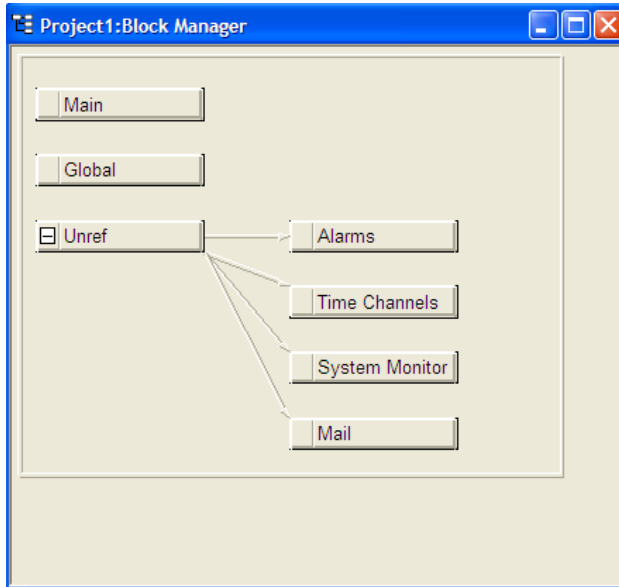

When the Block Manager is displayed, the *The Block Manager Toolbar* and the *The Zoom Toolbar* are highlighted.

### The Block Manager Toolbar



The buttons in the **Block Manager Toolbar** are used to add blocks and to display the properties dialog for the selected block. Additionally, regular block jumps can be added, as well as function key and touch key block jumps.

## Creating Blocks

Right-click on the Block Manager and select **New Block** to add a block in the project. A dialog with basic properties for the block is displayed.

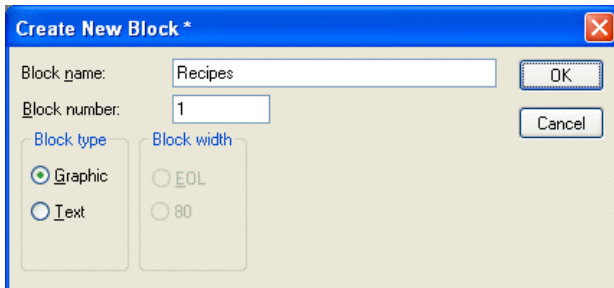

### Block name:

A name for the block can be entered here. The block name is shown in the Block Manager, in the Project Manager and in the Block List.

### Block number:

The number of the block. Block 0 is created automatically, and must always be used in a project.

### Block type

Select block type; graphic or text.

When clicking **OK**, the block is opened.



## Block Properties

Right-click on a block in Project Manager or in the Block Manager and select **Properties** to enter more detailed information about the block.

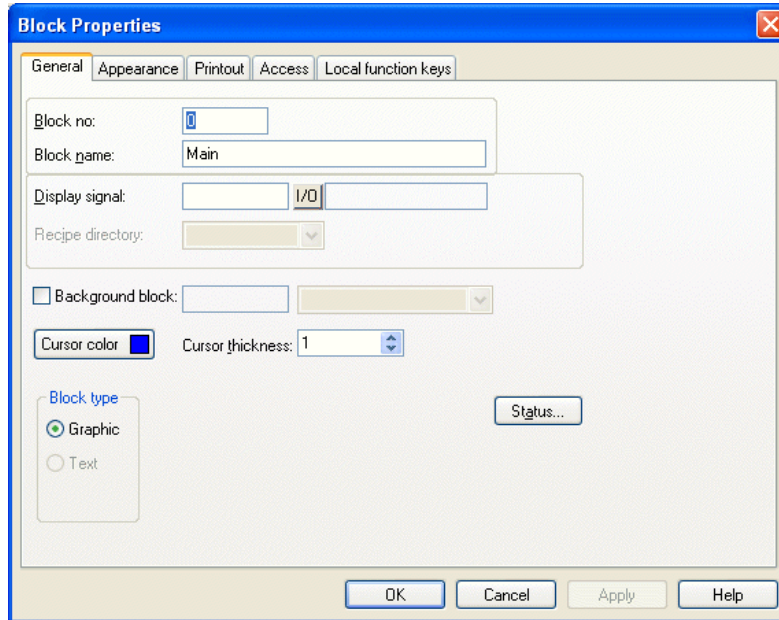

*The appearance of the properties dialog differs depending on the selected block type.*

### General

The following properties are defined under the **General** tab:

#### Block no:

The number of the block.

#### Block name:

A name for the block can be entered here. The block name is shown in the Block Manager, in the Project Manager and in the Block List.

#### Display signal:

A digital signal which, when activated, results in the block being shown on the operator panel's display. To change blocks as quickly as possible, display signals in consecutive order should be used. This field is not filled in if another method of changing blocks is used.

#### Recipe directory

Select a recipe directory in which all recipes created in the block will be saved. See the chapter [Recipes](#).

### **Background block:**

Only applicable for graphic blocks. Not available for E1012 and E1022. It is possible to select another block as the background block, to, for example, use the same background in more than one block. Select **View/Options/Show Background Block** when the Graphic Block Manager is active to show the background block when the actual block is edited.

---

### **Note:**

Only one dimension of background blocks can be used; i.e. when a background block is used, the background block of the background block will not be displayed in the operator panel.

---

### **Cursor color:**

Only applicable for graphic blocks. Select the color of the cursor in the operator panel. Not available for E1012, E1022 and E1032.

### **Cursor thickness:**

Only applicable for graphic blocks. Select the thickness of the cursor in the operator panel. Not available for E1012 and E1022.

### **Block type**

The block type was selected when the block was created, and cannot be changed.

### **Status**

Clicking the **Status** button opens the Block Options dialog, with the following properties for the status of the display in the operator panel. The properties do not affect system blocks.

**Disable main menu key:** Disables the [MAIN] key in the operator panel when the current block is visible on the display.

**Disable alarm list key:** Disables the [LIST] key in the operator panel when the current block is visible on the display.

**Auto data entry:** Moves the cursor automatically to the next maneuverable object after an input. The cursor can only be placed on maneuverable objects in this position.

**Disable PREV function:** Disables the [PREV] key and the function “Return to previous block” for the function keys in the operator panel when the current block is visible on the display.

**Disable ENTER function:** Disables the [ENTER] key in the operator panel when the current block is visible on the display. Only valid for digital objects.

### **Appearance**

Different colors and gradient styles can be selected under the **Appearance** tab.

**Printout**

The following properties are defined under the **Printout** tab:

**Print signal:**

A digital signal which, when activated, results in the block being printed out on a connected printer. **Display signal** and **Print signal** can be the same. Print signals in consecutive order should be used to obtain the fastest possible printouts.

**Completion signal:**

A digital signal activated by the operator panel when the printout is ready. The signal is normally set to one. If the box **Reset** is marked, the signal will be reset when the printout is ready.

**E-mail**

The E-mail tab is available for text blocks only. Not available for E1012 and E1022. The following properties can be defined:

**Send mail signal:**

The text block is sent as an e-mail message when the given digital signal is set to one. The block name corresponds to the e-mail message subject.

**Note:**

Only text blocks can be sent as e-mail messages.

**Mail completion signal:**

A digital signal activated by the operator panel when the message has been sent. The signal is normally set to one. If the box **Reset** is marked, the signal will be reset when the message has been sent.

**Mail to address:**

The address of the e-mail recipient is given here. Select up to 8 recipients from the list shown when clicking the ... button. The list of e-mail addresses is defined under **Setup/Network/Services/SMTP Client**. See section [SMTP Client](#) for information.

**Attach file:**

The name of a trend or recipe file to be attached with the message is given here. If there is a trend file or a recipe file with the same name, the trend file will be sent.

**Access**

The following properties are defined under the **Access** tab:

**Security Level:**

A security level (0-8) for the block is defined. If a security level other than 0 is stated, the operator must log in with a password corresponding to the given security level or higher.

**Local function keys**

Local function keys for the block can be defined under the **Local function keys** tab. See the chapter [Function Keys](#) for information. See also section [The Block List](#).

## 3.9 Showing Operator Panel around the Working Area

When double-clicking on a block in the **Blocks** folder in the Project Manager, an image of the current operator panel is drawn around the working area of the active block. Function keys, LEDs and text fields in the image can be edited by double-clicking on the image. This function can be turned off by unchecking the option **View/Options/Show Terminal**.

### Defining Function Keys

Double-click on a function key to create a local or global function key. The **Function Keys** tab in the Block Properties dialog is displayed. For a definition of function keys, see the chapter [Function Keys](#).

### Defining LEDs

Double-click on an LED to configure it. For definition of LEDs, see the chapter [LEDs](#).

### Creating Text Strips

Double-click on a text strip to display a dialog where text can be entered and adjusted, and background color and font can be selected. This function enables complete text strips to be designed and then printed out on plastic film, to be used on the operator panel.

## 3.10 Configuration of Blocks

Double-click on a block in the **Project Manager**. The working area for the block and the Objects Toolbar are now shown. The working area is the Graphic Block Manager or the Text Block Manager, depending on whether a graphic block or text block is opened. All objects that can be created in the block are available from the Objects Toolbar.

### The Objects Toolbar

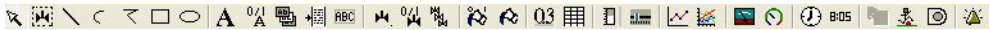

*The objects available differ depending on the selected operator panel and on the block type.*

An object is selected by clicking on it in the **Objects Toolbar** and placing the object in the working area using the cursor. Click to open the properties dialog for the selected object. Fill in the parameters, and click **OK**. The object is now shown in the working area. Static text or graphics are drawn directly in the working area.

The static graphic objects line, arc, ellipse, rectangle, symbol and text are used to draw background graphics. When static graphic objects are created signals can be linked to the objects under **Dynamics**, and in so doing make them dynamic.

The dynamic objects are linked to signals to create control and monitoring functions.

General parameters for the objects are described in the chapter *General*. The chapters *Graphic Presentation and Maneuvering* and *Text-based Presentation for Printouts and Reports* describe graphic and text objects.

In addition to the different objects, a button for selecting symbols and a marking pointer are also available, located to the very left on the toolbar.

See also section *Static Symbols*.

### The Alignment Toolbar



The **Alignment Toolbar** makes it easy to arrange multiple objects on the screen neatly. Objects can be aligned vertically and horizontally, and their size can be adjusted according to the last selected/created object (the reference object). Objects can also be distributed evenly, and tiled, using the buttons in the toolbar. When placing the cursor on a button in the toolbar, a short description is displayed as a tooltip, as well as a closer description in the **Status bar** at the bottom left of the screen.

## The Layout Toolbar



The buttons in the **Layout Toolbar** are used to send objects to the front or back of each other, and to show or hide a grid.

## The Color Toolbar

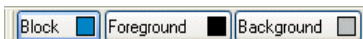

The **Color Toolbar** shows the foreground color and background color of a selected object, as well as the block color. Clicking on the buttons allows selecting other colors from the palette. Not available for E1012, E1022 and E1032.

## The Line Width Toolbar

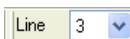

Select a line width used for lines, arcs, poly lines, rectangles and circles. The line width can also be selected from the object's properties dialog.

## The Font Toolbar



The **Font Toolbar** is used to select a pre-defined text style or to create user-defined styles. The text style is defined for the currently selected object. Selecting another font, font size or font style for an object creates a new text style in the drop-down list to the very left. Not available for E1012 and E1022.

## The Zoom Toolbar



The buttons in the **Zoom Toolbar** are used to zoom into or out from the working area or the Block Manager.

## Selecting Several Objects

Several objects in the working area can be selected at the same time by drawing a frame around them with the marking pointer. Alternatively, click on several objects while keeping the **Shift**-key pressed.

## Grouping Objects

After marking some objects on the working area, these can be grouped by selecting **Layout/Group**. Grouped objects are treated as one object, the size of which can be changed. The color and font can be changed individually for the objects in a grouped object. When clicking on an object in a grouped object, the editing dialog for that object is displayed.

Select **Layout/Ungroup** to ungroup a grouped object.

## The Library

The Library contains a number of catalogues with different symbol objects. It is also possible to define user-created catalogues by right-clicking on the Library and selecting **Catalogue/New**.

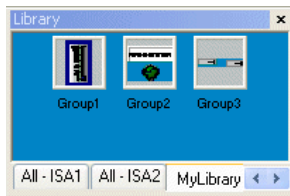

Grouped objects and symbols can be saved in the Library for reuse later, or in other projects. Right-click on a grouped object or symbol on the working area, select **Copy**, and then right-click in the Library and select **Paste**. A library object can be dragged from the Library to the working area.

By right-clicking on the Library, it is possible to customize the look of the Library. Library catalogues can be closed by right-clicking on the catalogue and selecting **Catalogue/Close**.

The Library can be hidden by selecting **View/Toolbars/Library**.

Symbol objects that are used in a project are saved in the project folder. These symbols can also be selected from the **Select Symbol** dialog, described in chapter [Static Symbols](#).

### Saving Symbols to the Library

Select one or several objects (grouped or ungrouped) on the working area with the cursor. Right-click on the selection and select **Copy**. Right-click in the Library and select **Paste**.

## Creating Series

Series of objects can be created in graphic blocks. Line up objects in a row or columns with the same object.

Then select the objects (not text objects), and choose **Object/Create Series**.

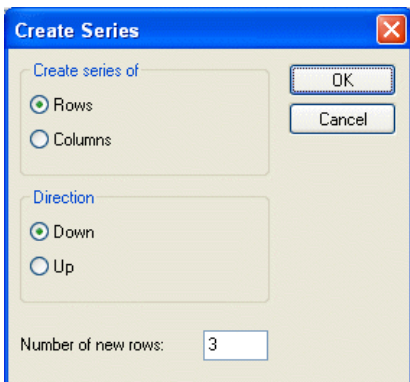
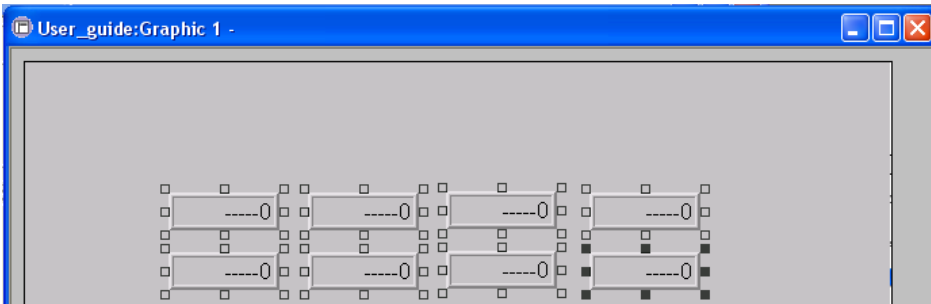



Select to create rows or columns, the number of rows/columns, and in which direction the series should be expanded. Click **OK** for the configuration tool to create a table with the specified number of lines or columns.



---

**Note:**

The lead text must end in a number for the table to be created.  
The Alarm banner object cannot be included in a table.

---

### 3.11 Using Text Blocks

For information of how to use text block, see the chapter *Text-based Presentation for Printouts and Reports*.

## 3.12 Static Symbols

Static symbols can be imported to the project, either from the bitmap library, where a number of buttons, pump symbols etc. are located, or by browsing the PC for graphic files. Graphic files in the formats .bmp, .jpg, .gif and .wmf can be imported to the bitmap library from another Windows program, e.g. Paint. A maximum of 30 characters can be used for symbol names. Country specific characters are allowed. E1012 and E1022 support black and white symbols only. How to manage symbols for E1012 and E1022 is described in section [Symbol Manager for E1012 and E1022](#).

### Adding a Symbol

Click on the **Symbol** button in the Objects Toolbar to display the Static Symbol dialog. Type the name of the symbol to add, or click **Select** to display the Select Symbol dialog. Click **Library** to select a static symbol from the bitmap library, or click **Browse** to select a graphic file from any location in the PC.

A selected symbol can be displayed in the **Preview**-window. All symbols in bmp-format are displayed as thumbnails in the window.

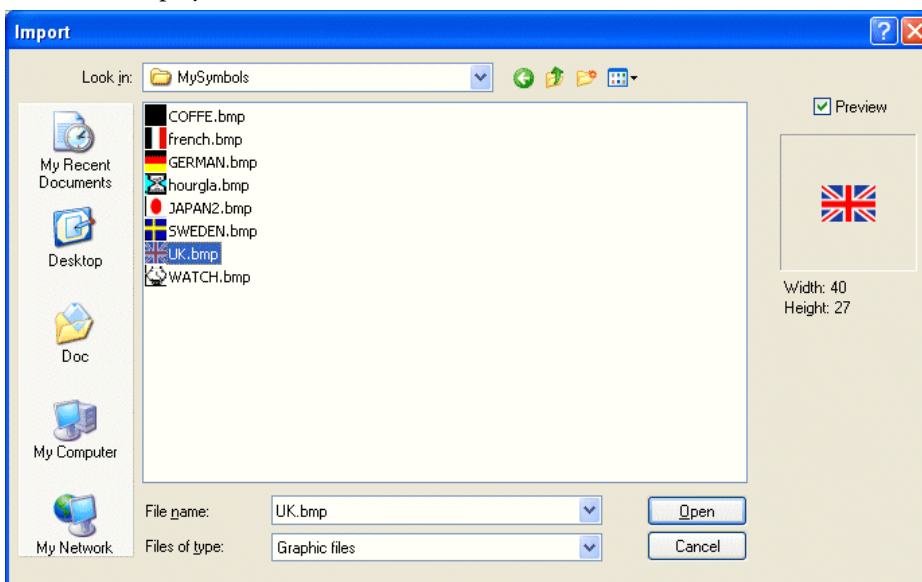

Click **Open** and **OK** to select a symbol. The symbol is now visible in the Static Symbol dialog.

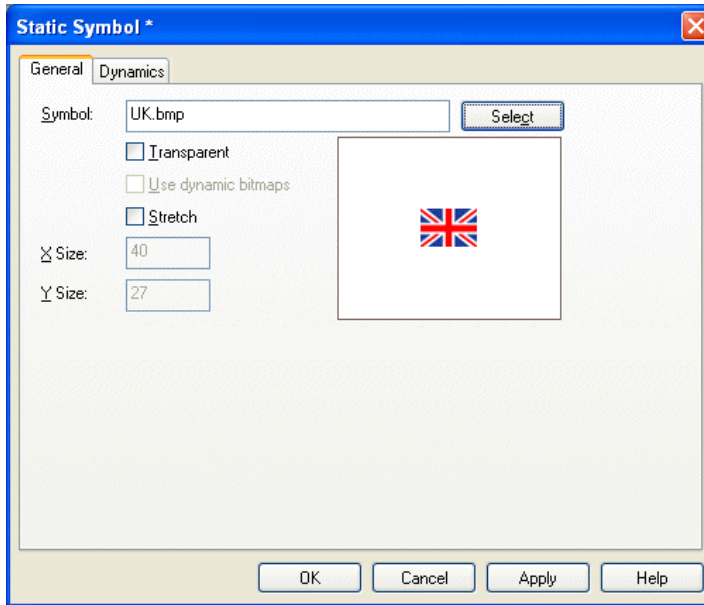

## General

Parameter	Description
Symbol	The symbol name of the selected symbol.
Select	Button used to select symbols from the library or browse for graphic files in the PC.
Transparent	Makes the background of a symbol transparent. The color of the top left pixel in the image controls which color will be transparent.
Stretch	When selected, the object's X and Y size can be changed.

## Dynamics

The functions under the **Dynamics** tab are described in the section [General Parameters](#) in chapter Graphic presentation and maneuvering.

## Copying Graphics from Other Programs

Use the copy function in the other program (e.g. Paint). Right-click in the Library and select **Paste**. Enter a name for the symbol.

The symbol is now saved in the symbol library with the given name.

With the copy and paste functions in the configuration tool it is possible to copy graphics and symbols between blocks and between projects.

### Note:

When a user-defined symbol is copied between projects, the actual symbol is only copied if the symbol is not already used in the target project.

## Symbol Manager for E1012 and E1022

E1012 and E1022 support black and white symbols only. The Symbol Manager for E1012 and E1022 is activated by selecting **View/Symbol Manager**. In the Symbol Manager there are functions for import and export of bitmap symbols. User-defined symbols can also be created and deleted from the symbol library. The user-defined symbols are shown in the symbols list. The pre-defined symbols are not shown since they cannot be changed. The configuration tool is delivered with a number of different symbols.

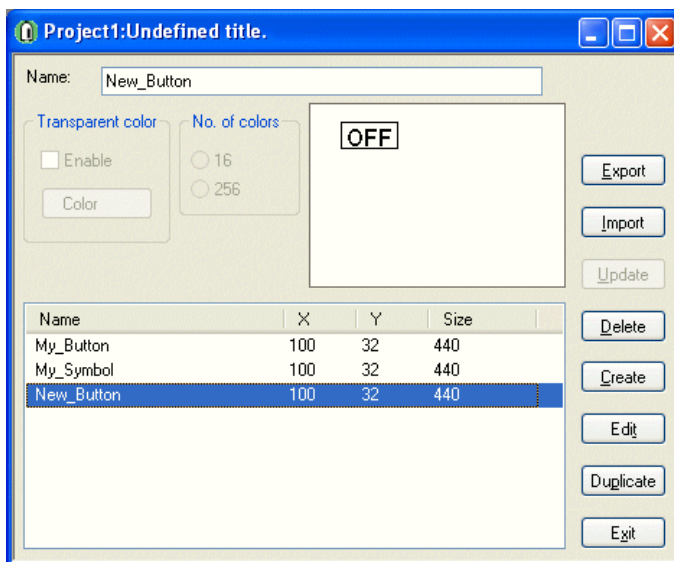

### Export Symbols

Symbols in bmp format can be exported for use in other applications.

## Import Symbols

The import function makes it possible to reuse symbols from other applications. Image files in the formats bmp, cmp, dcx, fpx, jpg, mpt, pcd, png, tga, tif and pcx can be imported to the symbol library from another Windows program, e.g. Paint.

## Create

The **Create** function is used to draw a new symbol. When you click on the **Create** button you are asked to name the symbol you want to create. A bitmap manager opens when you click **OK**. The bitmap manager works as a standard drawing program, depending on the limitations of the current panel.

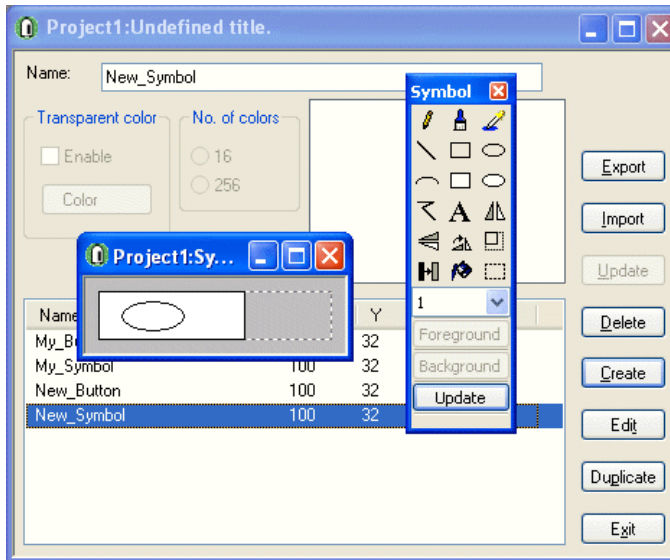

When the right mouse button is pressed, you can draw with the background color. If the background is white it will seem as if you are deleting.

## Edit

The **Edit** function activates the bitmap manager for a defined symbol.

## Duplicate

The **Duplicate** function is used to create a copy of the current symbol with a new name.

## Delete

The **Delete** function is used to delete a symbol from the project.

### Adding a Static Symbol in a Block

Click on the object Symbol in the toolbox, place the pointer on the working area in the block where you want to place the symbol, and click. The Static symbol dialog is shown when you click in the working area. Click Select.

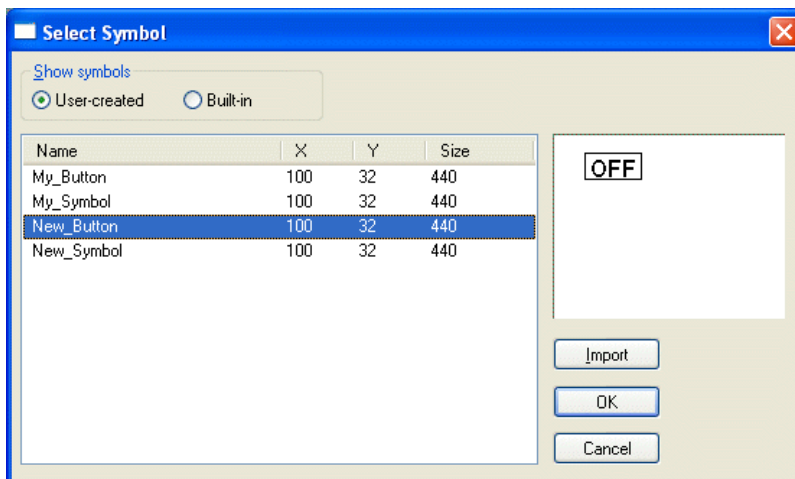

Select the symbol to be shown, **User-created** or **Built-in** and click **OK**. When **Stretch** is selected, the object's X and Y size can be changed.

## 3.13 Changing I/Os

The function **Change I/O** allows you to change an I/O to another, or move a complete I/O area. I/Os can be changed in the entire project, or only in the objects marked when the function is selected.

Select **Edit/I/O Change**.

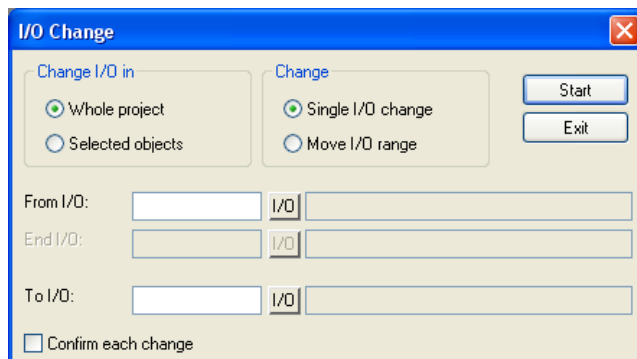

### Change I/O in

Select whether you want to change I/Os in the entire project or for selected objects.

**Change**

Select whether one I/O is to be changed, or whether if the complete I/O area is to be moved.

**From I/O, End I/O, To I/O**

State which I/O is to be changed, and to what or which I/O area it is to be moved.

**Confirm each change**

Select whether you want to confirm changing the I/O for each object.

## 3.14 The I/O Browser

If a local name list is created in the project, I/O signals can be selected from the list, using the button **I/O** when objects are defined. The button **I/O** is included in all dialogs where an address can be stated. The I/O Browser has incremental searching. This means that searching begins immediately when you start entering in the characters in the **Name/Address** field. The I/O list can be sorted by different properties.

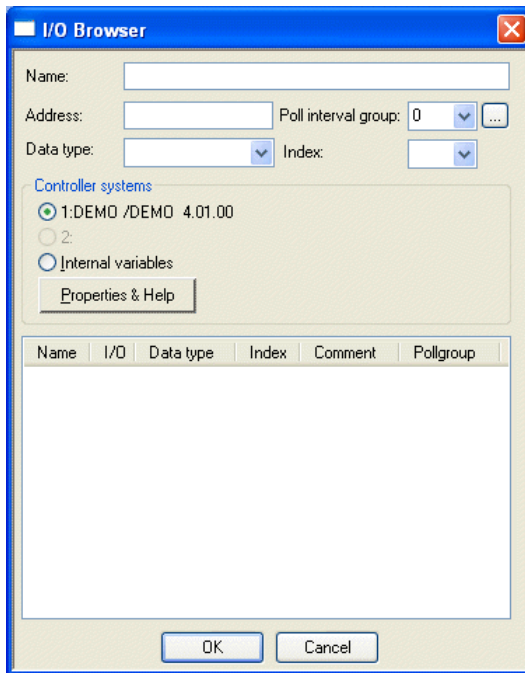

## 3.15 Changing BDTP Station

This function allows you to change the index numbering in a BDTP client project included in a BDTP network, e.g. from station 1 to station 3. Not available for E1012 and E1022.

Select **Edit/BDTP Station Change**.

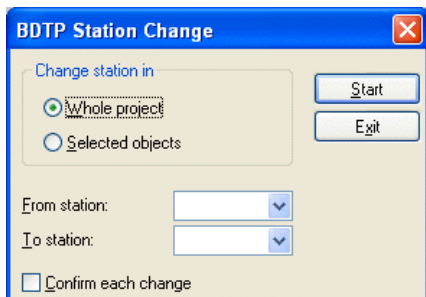

### Change station in

Select whether to change the index numbering in the entire project, or for marked objects.

### From station, To station

The index number to be changed is indicated here, and to which BDTP station index number it is to be changed to.

### Confirm each change

Select if you want to confirm changing the BDTP station for each object.

See the section [BDTP](#) for information about BDTP.



## 3.16 I/O Cross Reference

The I/O cross reference function is used to document I/Os in a well-arranged way. Select **View/I/O Cross Reference**.

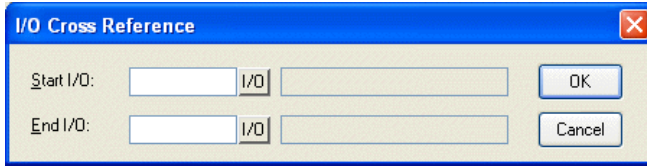

**Start I/O** and **End I/O** can be stated in the dialog. If the **Start I/O** field is left blank all I/Os to the value in the **End I/O** field will be included. If the **End I/O** field is left blank all I/Os from the value in the **Start I/O** field will be included. If both fields are left blank all I/Os will be included in the list.

The results are presented in a list with two levels. The first level shows which I/Os are used and how many objects refer to each respective I/O.

The second level is displayed by clicking on the + character to the left of the I/O. The objects containing the I/O you have clicked on will now be shown. The + character becomes a - character

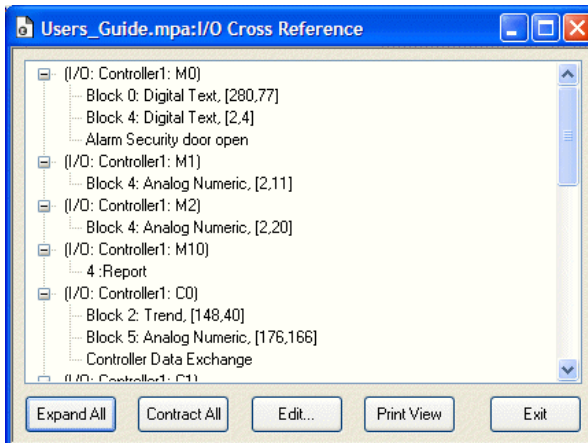

A line in the list can be marked and copied to the clipboard, from where it can be pasted into, for example, a Microsoft Word document.

## 3.17 Other Managers/Editors

The configuration tool also has managers/editors for e.g. alarms, passwords, time channels, message libraries, macros and data logging. These are activated by double-clicking in the Project Manager and are handled similarly. The managers are described in the respective chapters.

## 3.18 The File Menu

The **File** menu contains functions for creating, opening, saving and closing projects, also available from the Standard Toolbar. Printout options are also accessed from this menu. With the functions **Update Drivers From** you can update the drivers from the Internet and from disk, see the section [Updating Drivers](#).

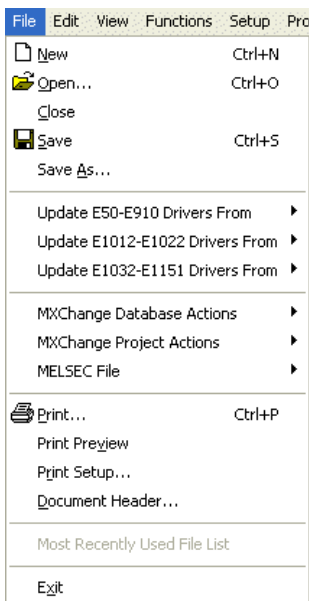

### FastLinX and MXChange

FastLinX functions, used in order to make connections to an MXChange database, are available when a Mitsubishi driver is selected in the E-Designer project.

#### Software concept

FastLinX connects E-Designer and GX IEC Developer so that tags defined in one package are linked to the other package and will be updated whenever changes are made (e.g. if the address of a tag is changed). The connectivity between E-Designer and GX IEC Developer is powered by MXChange. MXChange integrates Mitsubishi Electric automation development tools into a single environment which harmonizes programming, supervision, network configuration, and simulation components.

## MXChange Database Actions

The menu options in the **MXChange Database Actions** menu apply to the selected driver.

### Note:

The menu options in the **MXChange Database Actions** menu apply to the entire MXChange database, not just the current project.

Select **MXChange Database Actions/New** to display the following dialog.

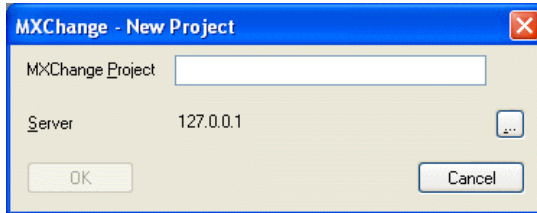

In this dialog it is possible to create a new database to an existing MXChange server. Available MXChange servers in the network are displayed by clicking the ...-button.

Select **MXChange Database Actions/Open** to display the following dialog.

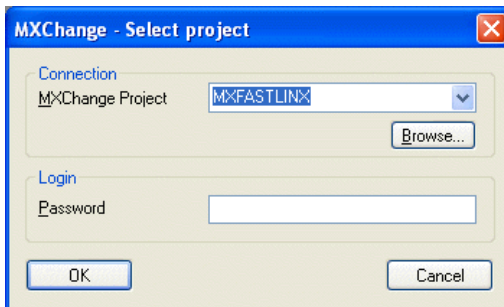

Select which database to open, either by typing its name or by browsing, and enter the password if necessary. An icon in the E-Designer status bar indicates that the connection is established, and the other database options in the menu becomes available.

Selecting **MXChange Database Actions/Save As** makes it possible to save the current MXChange database with another name.

Selecting **MXChange Database Actions/Delete** deletes the current MXChange database and all the projects within it.

### Note:

This destroys every project in the database, not just the current project (if any).

Two confirmation dialogs will be displayed.

Selecting **MXChange Database Actions/Compact** reduces the size of the MX-Change database file by removing any unused space.

Selecting **MXChange Database Actions/Change password** changes the password to the MXChange database (normally left blank). In the window that appears, you must enter the old password correctly for security, and then type the new password twice to make sure that it is typed correctly.

Selecting **MXChange Database Actions/Close** closes the MXChange database.

### **MXChange Project Actions**

The menu options in the **MXChange Project Actions** menu apply to the selected driver, and the actions apply only to the current project within MXChange.

Select **MXChange Project Actions/Name List** to display the E-Designer name list for the selected project.

Selecting **MXChange Project Actions/Global Adjust** is used to make sure that the MXChange server and the E-Designer project have the same information for all tags. The MXChange database is treated as the “master” tag list, and in cases where the E-Designer project and the MXChange database differ, the information from MXChange is used. The global adjust will be performed in about 10 seconds.

Selecting **MXChange Project Actions/Delete** completely deletes the current E-Designer project from MXChange and breaks all tag links.

### **MELSEC File**

The menu options in the **MELSEC File** menu apply to the selected driver, and is used to import variable naming from MELSEC MEDOC or GX IEC Developer. The file formats .nam, .asc and .csv are supported.

## 3.19 The Edit Menu

The **Edit** menu contains functions for cutting, copying, pasting, undoing and selecting all, also available from the Standard Toolbar. The **Find** function is accessible when editing multiple language texts. The menu also includes the functions *Changing I/Os*, *Changing BDTP Station*, selection of default controller and font templates.

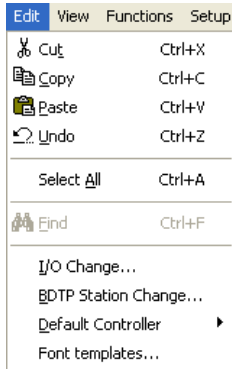

## 3.20 The View Menu

Different managers, tools, toolbars and features can be displayed/hidden from the **View** menu.

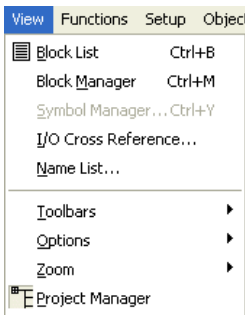

### The Block List

The Block List lists the blocks included in the application. New blocks can be created using the **New**-button, and existing blocks are opened with **Open**. Block properties are displayed when clicking **Properties**. Selected blocks can be removed using the **Delete**-button.

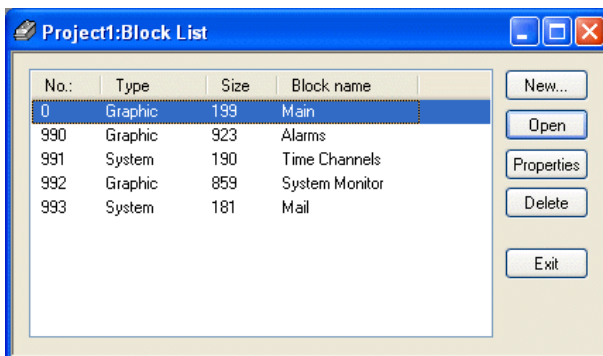

### Block Manager

The Block Manager shows which blocks are included in the application graphically. You can create new blocks here, define the block header and define jumps with the functions in the toolbox. See the section [The Block Manager](#).

### I/O Cross Reference

Under **I/O Cross Reference** you can document I/Os in a well-arranged way. See the section [I/O Cross Reference](#).

## The Name List

A local name list for the signals used can be created using the Name List.

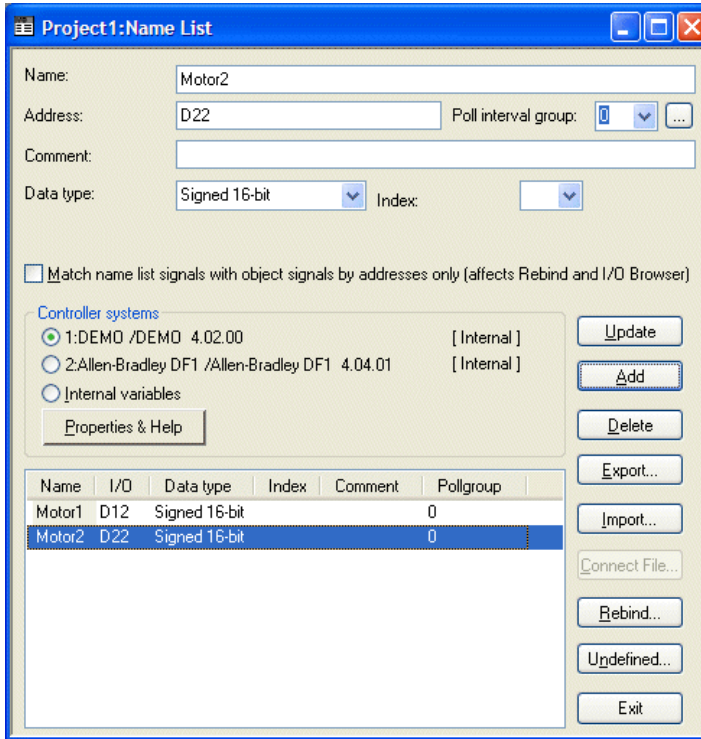

When using the name list, it is the name, and not the address, that is unique.

Signals in the project which are not named can be inserted in the name list with the function **Undefined**. New signals can be added and existing ones can be edited and updated. The **Rebind** function has to be used to update the project with the changes made in the name list.

Rebind can be performed in two different ways.

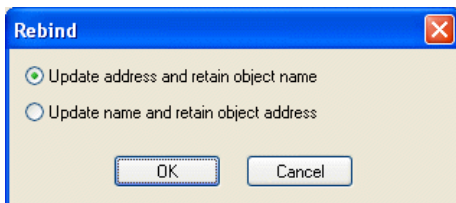

If **Update address and retain object name** is selected, the addresses of all objects in the project is updated, but also data type, index and poll group interval, by matching their names with the signal names in the Name list.

If **Update name and retain object address** is selected, only the name is updated. In this case, signals in the Name list and signals in the project can be matched in two different ways, using the **Match name list signals with object signals by addresses only** check box in the Name list configuration window. The default setting (unchecked box) means that signal names in the project is updated only if address, data type, index and poll group interval correspond. Checking the box results in matching only by address.

---

**Note:**

When using the Rebind function and having selected **Match name list signals with object signals by addresses only**, address duplicates (two or more signals with the same address in the Name list) will not be handled. The address duplicates will be matched with the same signal in the project. The signals will get their name from the latest matched signal in the Name list when performing Rebind.

---

### Recommendation when importing signals

Avoid using address duplicates when importing signals that do not have all properties (data type, index and poll group interval). Check **Match name list signals with object signals by addresses only** before performing Rebind.

### Recommendation when e.g. different poll group intervals are needed

When address duplicates are used because of different poll group intervals, uncheck **Match name list signals with object signals by addresses only** before performing Rebind to rebind using all properties.

A name list can be exported to a text file, and a text file can be imported to a name list. The contents of the file can be separated either with a semicolon, comma or space. An internal name list can be sorted. The text file should not contain national characters.



The **Connect File** button is used to import variable naming. The file types \*.nam (Melsec Medoc), \*.asc (GX IEC Developer) and \*.csv are supported. Some Melsec drivers have a built-in import functionality. See respective driver help file for information. In these cases the **Match name list signals with object signals by addresses only** has no influence.

## Toolbars

All toolbars can be shown/hidden.

## Options

### Show Terminal

See section *Showing Operator Panel around the Working Area* for information.

### Show Background Block

Only applicable for graphic blocks. Background blocks are shown when editing in the Graphic Block Manager.

### Show Language Index

Displays the index number for the texts used in the application.

### Tool Tips

Shows lead texts for the function or object that the cursor points to.

### Choose Unicode Font

Choose the Unicode font that will be used in the configuration tool.

## Project Manager

Choose whether to show the Project Manager or not under **View/Project Manager**.

## 3.21 The Functions Menu

In the **Functions** menu there are managers for function keys, LEDs, alarm groups, alarms, time channels, passwords, message libraries, macros, data exchange, data logger and I/O configuration.

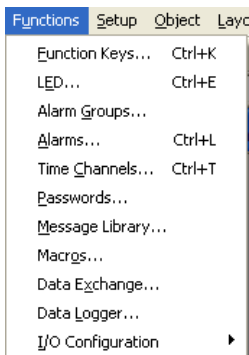

### Function Keys

Global function keys can be defined by selecting **Function Keys**. See the chapter [Function Keys](#).

### LED

LED functions can be defined by selecting **LED**. See the chapter [LEDs](#).

### Alarm Groups

Alarms can be grouped, e.g. according to degree of seriousness, by selecting **Alarm Groups**. See the chapter [Alarm Management](#).

### Alarms

Alarm messages and which signals are to activate the alarms can be defined by selecting **Alarms**. See the chapter [Alarm Management](#).

### Time Channels

**Time Channels** can be used to control events in the process at special times. See the chapter [Time Channels](#).

### Passwords

Passwords for the different security levels in the application can be defined by selecting **Passwords**. See the chapter [Passwords](#).

## Message Library

Message tables, where values between 0 and 65,535 are linked to texts can be created by selecting **Message Library**. See the chapter *Message Library*.

## Macros

Events to influence all function keys and touch keys can be created by selecting **Macros**. See the chapter *Macros*.

## Data Exchange

By selecting **Data Exchange** conditions for data exchange between selected controllers can be defined. See the chapter *Communication*.

## Data Logger

Data can be logged and saved to file on different intervals or depending on changed values. Not available for E1012 and E1022. See the chapter *Data Logger*.

## I/O Configuration

The properties for the driver of the connected controller or for internal variables are displayed by selecting **I/O Configuration**.

## 3.22 The Setup Menu

The operator panel can be configured using the **Setup** menu.

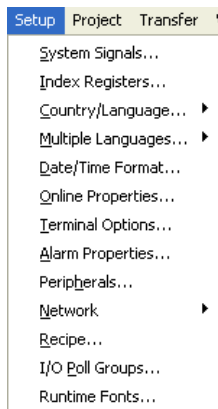

Many properties can also be made from the **Setup** and **Peripherals** folders in the Project Manager.

### System Signals

#### Current display register

Data register in the controller, which when the operator panel is running contains the number of the block shown on the display. The data register is updated automatically by the operator panel when changing blocks. This register does not affect the selection of blocks.

#### New display register

A data register in the controller, which controls which block is to be shown on the display.

#### Buzzer register

A register value to determine the sound of the buzzer. See the table of tones and scales below. The buzzer is off if the value is 0. The units in the table are in Hz.

	C	D	E	F	G	A	H
Small	-	-	-	-	-	220	247
One	262	294	330	349	392	440	494
Two	523	587	659	698	784	880	988
Three	1046	1174	1318	1397	1568	1760	1975
Four	2093	2348	2636	2794	3136	3520	3950
Five	4186	-	-	-	-	-	-

**Note:**

The buzzer in E1012 and E1022 can only produce one tone.

**Backlight signal**

Digital signal which controls whether the display is to be switched on or off.

**Note:**

The function keys will be disabled if the backlight of the panel is disabled.

**Cursor control block**

Only applicable for key pad models:

Start register in a control block which enters the current cursor position in the graphic block to the register in the controller

Register	Description
Ctrl.reg. 0	Current graphic cursor position X (in pixels).
Ctrl.reg. 1	Current graphic cursor position Y (in pixels).
Ctrl.reg. 2	Status register 0 Normal 1 The user tries to move down, but there is no object below. 2 The user tries to move up, but there is no object above. 3 The user tries to move to the left, but there is no object to the left. 4 The user tries to move to the right, but there is no object to the right.

Only applicable for touch display models:

Start register in a control block which enters the current pointer position in the graphic block to the register in the controller.

Register	Description
Ctrl.reg. 0	X co-ordinate (in pixels).
Ctrl.reg. 1	Y co-ordinate (in pixels).
Ctrl.reg. 2	Status register 0 Not pressed 1 Pressed

### Cursor move register

The position of the cursor in a graphic block can be controlled through a register. The values in the register have the following implications. The register must be allocated the value 0 between the same command for Move. To optimize the function it is recommended to use it together with the function Cursor. Ctrl block.

Register value	Description
1	Moves the cursor to the first maneuverable object.
2	Moves the cursor to the next maneuverable object.
3	Moves the cursor one step up.
4	Moves the cursor one step down.
5	Moves the cursor one step to the left.
6	Moves the cursor one step to the right.

### Printer status register

Not applicable for E1000-series, except for E1012 and E1022.

### Library index register

Used for indexing of the message libraries. The number of the library the texts are to be collected from is indicated in the message object. If an index register is defined, the contents of the index register are added to the number given in the object. This makes it possible to control from which library the texts are to be taken with a register.

### Dim backlight register

Controller register which controls the dimming of the backlight (0-100%).

### Contrast register

Controller register which controls the contrast in the operator panel. A value between 0 and 100 can be entered, where 0 is the darkest and 100 the lightest. The default value is 50.

### Commands

On the commands line it is possible to give one or more of the following commands. The commands are typed with all capital letters. The commands are separated by a space. Not all commands are supported by all operator panel models.

Command	Description
ABUPx	Allows saving alarms on an external memory card by setting the bit device x. See the section <a href="#">Alarm Backup</a> for more information.
AKx	Activates Joystick function. See the section <a href="#">Joystick Function</a> .

Command	Description
ALDR	Allows using two alarm rows per alarm. See the section <a href="#">Alarms in the Operator Panel</a> .
ALOFx	AlarmListOverflow. If any active alarms are deleted from the alarm list, this is indicated by the bit device x.
AMBn	Allows storing multiple alarm backup files on an external memory card. n indicates the number of backup files that can be stored. See the section <a href="#">Alarm Backup</a> for more information.
AUCR	AlwaysUpdateCurrentRecipe Register. Updates the Current recipe register when saving a recipe. It's not necessary to load the recipe again.
BCTO	Displays message "BDTP comm. Error" the first time only that a BDTP client tries to reconnect to an unavailable BDTP server.
BFF	Block Form Feed. Adds page breaks after each block when printing.
BTIMx	BDTP reply timeout, where x represents number of seconds. See section <a href="#">BDTP</a> for details.
DBAF	Deactivates the question about creating a backup file structure when a USB Flash drive is connected. See section <a href="#">Password Handling via USB Flash Drive</a> for more information.
DBKL	Deactivates locking of keys and touch screen if background lighting requires replacement. With the default setting, keys and touch screen are locked if background lighting is inoperable.
DD	Disable Delete of alarms on alarm list. When specified, inactive and acknowledged alarms cannot be deleted from the alarm list.
DGP	Deletes the alarm group from alarm printouts.
DNBW	Deactivates warning message "No block x". The message is otherwise displayed if a block jump is configured to a block number that does not exist or when the function New picture register is used to permit a data register in the controller to control the block that is presented on the display.
FLIP	Rotates the screen picture 180° in landscape as well as portrait mode to make up-side-down mounting possible.
FTNO	Deletes rows with OFF flags in trend files when FTP is used.
LOBx	Sets the digital signal x when the real-time clock's battery requires replacement. Example: LOBMO will set M0 when the battery requires replacement.
MCIx	MemCardInserted. Sets the digital signal x when a memory card is inserted.
MCRD#	Allows saving individual recipes on an external memory card. See section <a href="#">Saving Individual Recipes on an External Memory Card in Runtime</a> .
NHD	The command enables graphic blocks to be printed on laser printers without headers (which contain block names, block numbers, dates and times).

Command	Description
NMAN	Activates warning message "Not maneuverable" for an object in operator panels with touch screens.
NTx	Timeout in x number of ms for messages in No protocol mode.
PDxxxxxxx	Password that protects access to TRANSFER menu. See the chapter <a href="#">Passwords</a> .
PLCU	Enables transfer of MELSEC FX (serial) controller program and parameters to a USB Flash drive. See section <a href="#">Transfer of Controller Program and Parameters</a> for details.
PSxxxxxxx	Password that overrides all other password levels. Useful for support and maintenance, for example. See the chapter <a href="#">Passwords</a> for more information.
PSCE	Enables project size calculation and displays the result in the Diagnostic page and in the file info.txt. Using the command in projects with a large number of trend curves will considerably slow down loading the diagnostic page and using FTP functions. See sections <a href="#">Diagnostic Page</a> and <a href="#">FTP Server</a> .
PWDF	Activates using a password on a USB Flash drive. See section <a href="#">Password Handling via USB Flash Drive</a> for more information.
SCRR	Limits the number of characters for recipe names and recipe directories written to the controller to 8. See the section <a href="#">Limiting the Size of Recipe Names and Directories Written to the Controller</a> for details.
SJAFx	Displays the text "Remote access" in the upper right corner when a VNC client is connected. x = character size.
TBS	The command is to be followed by one character that indicates which trends or data loggers that are to be copied to the external memory card. Only trends and data loggers that begin with this character will be copied when the TBUP signal is set. See the chapter <a href="#">Trends</a> .
TBUP	Used for backup copy of trend files on external memory card. See the chapter <a href="#">Trends</a> .
TCFx	Divisor to regulate the temperature compensation of the operator panel's contrast. Default value is set according to testing, but may require adjustment in environments with large and frequent temperature variations. To decrease the temperature compensation, increase the divisor (x). The divisor "0" shuts off the temperature compensation.
TESOSn	Storage of one trend sample. See the chapter <a href="#">Trends</a> .
TMBx	Trend Multi Backup. See the chapter <a href="#">Trends</a> .
VNCDx	VNC Disconnect. Disconnects the current VNC session when the bit device x is set.

## Index Registers

Index addressing of dynamic objects. For further information, see the chapter [Index Addressing](#).



## Country/Language

### Character set:

The selection of the character set will influence the character table used in the operator panel and the national characters that will be available.

### System languages:

Selection of menu language; British/English, German, Swedish or American/English. The default properties for the operator panel is British-English menu texts.

## Multiple Languages

### New Language

Start the wizard to create multiple languages for an application.

### Edit

Translated texts in the application languages can be edited.

### Setup

The tree structure is displayed for the languages in the application. For information about the properties that can be made, see the chapter [Language Management](#).

### Export

This function exports the user texts to a text file in Unicode format. Choose to export user texts. After making your choice, the **Export Multiple languages text** dialog box is displayed. Here you can specify where the file will be saved and its format.

### Import

This function imports a language that can subsequently be used in the operator panel. Choose to import user texts. After making your choice, the **Import Multiple languages text** dialog box is displayed. Indicate the name of the text file that you want to import.

### Show Index

This function is for displaying the language index instead of texts in the object. You may enter text even when the language index is shown. The new text will then receive a new language index.

### Cross Reference

Shows a cross reference list of the indexes for the various blocks in the application.

### Reuse Index

If this function is active when an object is copied, a new object is created with the same index.

### Choose Unicode Font

Choose the Unicode font that will be used in the configuration tool.

## **Date/Time Format**

Setting of the date and time format.

### **Date format:**

The format can be YY-MM-DD, YYMMDD, DD.MM.YY, DD/MM/YY or MM/DD/YY where Y=year, M=month and D=day.

### **Time format:**

The format can be HH:MM:SS or HH:MM where H=hour, M=minute and S=second.

### **Time zone (minutes):**

The local time zone offset to UTC (Coordinated Universal Time) given in the format +HH:MM or -HH:MM. The value should not include any daylight saving adjustment, since this is calculated separately.

---

### **Note:**

This setting is ignored unless SNTP time sync (see below) is used.

---

### **Clock used:**

Terminal means that the operator panel's built-in clock is used, and controller 1 or 2 means that the clock in controller 1 or 2 is used.

### **Clock→Controller 1/2:**

Select if the clock in the operator panel is to be transferred to a data register in the controller 1 or 2.

---

### **Note:**

In those cases where the controller has an activated real-time clock and the operator panel clock is to be transferred to the same data register, the controller clock has precedence.

---

### **Update interval (seconds):**

Indicate how often the operator panel is to transfer the clock data to the controller. The value is given in seconds, and 60 seconds is recommended. A shorter updating interval will make communication between the operator panel and the controller slower.

**Controller register:**

Enter the start address for storage of the date/time in the controller.

When this function is used, the operator panel clock will be written to 7 consecutive registers according to the table below.

Controller Register CR	Clock Part
CR	Seconds
CR+1	Minutes
CR+2	Hours
CR+3	Day
CR+4	Month
CR+5	Year
CR+6	Day of week (1-7 where 1 is Sunday)

**Use SNTP time sync**

Check the box if the panel's clock should be synchronized against an external SNTP server (Simple Network Time Protocol).

**Server name:**

The address of the SNTP server.

**Update interval (minutes):**

State the interval of how often the synchronization should be performed. Values below five minutes will not generate any synchronization at all.

---

**Note:**

If the time difference in the operator panel compared to the SNTP server exceeds 24 hours, no time synchronization will be performed, since this will be regarded as an intended setting in the operator panel project.

---

**Daylight saving:**

The start and end of summer or daylight saving time are defined here. State the Day of week, Week In Month, Month, Hour and Adjust. You can choose between European and US standard.

To disable the function for summer time leave both fields for the month blank.

**Online Properties**

Permits changing of the selected function in the operator panel.

## Terminal Options

The operator panel options include functions for the user interface, trend properties, selection of FTP delimiter and memory card settings. Some settings are not available for all operator panel models.

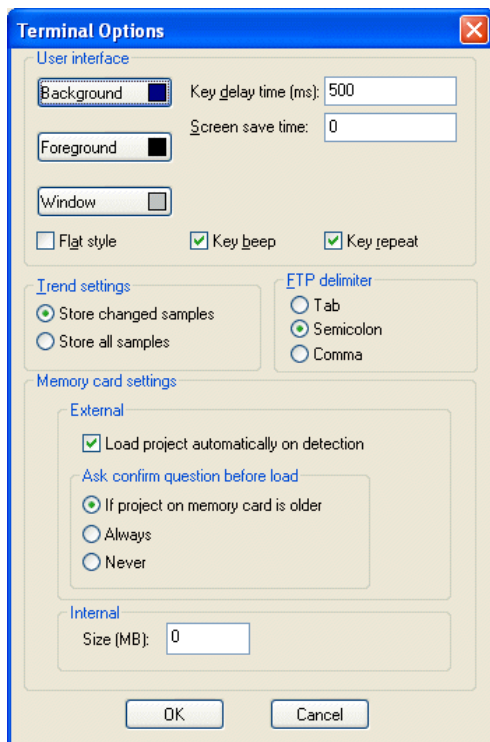

### Background

Select the background color in the operator panel. Not available for E1012 and E1022.

### Foreground

Select the color of the text in the operator panel. Not available for E1012 and E1022.

### Window

Select the color of the windows shown on the operator panels' display. Not available for E1012 and E1022.

**Key delay time (ms)**

The time interval in ms between pressing the same key on the operator panel before the cursor automatically moves to the next position. Used for input of ASCII characters (A-Z etc.).

**Screen save time**

The time in minutes after the last event on the display when it will switch off. The default setting is 0 which means that the display never switches off. This function optimizes the service-life of the display.

**Flat style**

Makes the keyboard layout in the operator panel look 2-dimensional. Only available for monochrome touch panels.

**Key beep**

Indicates whether the operator panel will beep when a key is pressed.

**Key repeat**

Indicates if a function will repeat as long as the key on the operator panel is pressed. Function keys and input of alphanumeric characters (A-Z etc.) are not repeated.

**Trend settings**

General properties for all trends. Not available for E1012 and E1022. See the chapter [Trends](#) for more information.

**FTP delimiter**

The operator panel can save the contents in files created in the operator panel. These can be reached through FTP or be accessed on an external memory card with different types of delimiter characters (separators). The content in files, e.g. recipe and trend files, can be separated with Tab or the characters semicolon or comma. If the FTP delimiter is changed, all recipes that are saved internally will be checked and the separator will be replaced. Not available for E1012 and E1022. See the chapter [Network Functions in the Operator Panel](#) for further information.

**Memory card settings**

---

**Note:**

Use of Compact Flash cards is not supported in the E1012, E1022, E1032, E1041, E1043, E1060, E1061, E1062 and E1063 operator panels.

---

**External**

Either a Compact Flash card or a USB Flash drive can be used externally. The external memory can be used for project backup, recipe files etc., but not for expansion of the project memory. Using two external memories simultaneously is not supported, and if two memories are connected, the Compact Flash card is used prior to the USB Flash drive.

See also the section [Transfer to/from External Memory Card](#).

## Internal

If an internal Compact Flash memory card is used for expansion of the project memory, the size of the card must be entered here.

## Alarm Properties

General properties for the alarm list. For further information, see the chapter [Alarm Management](#).

## Peripherals

Communication configuration can be made under **Setup/Peripherals**, or by double-clicking the **Peripherals** folder in the Project Manager. Devices can be moved by drag-and-drop.

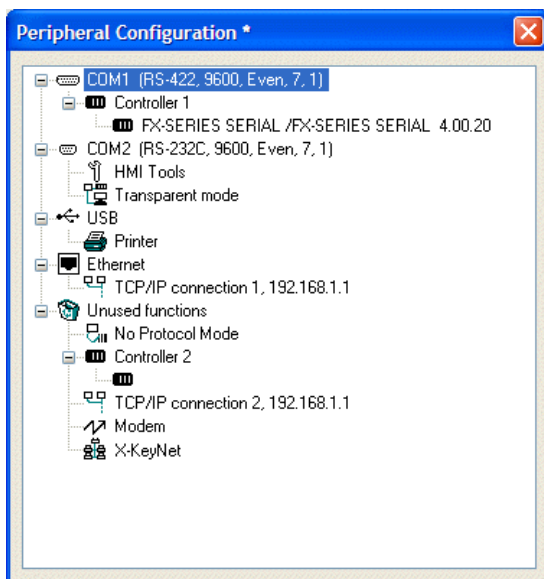

## Port Properties

Select the appropriate port and right-click to view current configurations or to change the configuration for a port.

### COM1 and COM2

COM1 and COM2 in the Peripheral configuration window represent the physical ports on the panel. When right-clicking on **COM1** or **COM2**, and selecting **Properties**, the following dialog is displayed. Select the transfer speed, connection, parity, number of data bits and stop bits for the port.

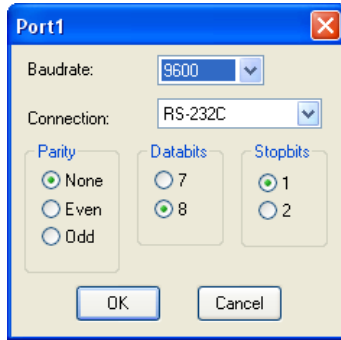

*Properties for COM2.*

COM1 can be configured as an RS422 or as an RS485 port.

Parameter	Description
Baud rate	Select baud rate for the communication; it should be the same as for the external unit.
Parity	Select parity; it should be the same as for the external unit.
Data bits	Select number of data bits; it should be the same as for the external unit.
Stop bits	Select number of stop bits; it should be the same as for the external unit.

### USB

External devices such as a USB hub, Flash drive, mouse or keyboard can be connected to the USB Host port. Not available for E1012 and E1022.

### Ethernet

The operator panel has a built-in Ethernet port for connection to a TCP/IP network. E1012 and E1022 do not have a built-in Ethernet port. For these models an Ethernet expansion module to be mounted on the back of the panel is available. The expansion module is configured by right-clicking on **Expansion port** in the **Peripherals** window. The expansion module can only be used for communication with controllers using Ethernet drivers and to load/receive projects; not for network functions.

## Printer

Select **Printer** and right-click to display the dialog box for printer properties. For more information, see the chapter *Printouts from the Operator Panel*.

## No Protocol Mode

No protocol mode is described in the section *The Operator Panel as a Communication Interface (No Protocol Mode)*.

## Controller 1 and Controller 2

Right-click on **Controller 1** or **Controller 2** and select **Properties** to change the selected protocol.

## TCP/IP Connection 1 and TCP/IP Connection 2

Right-click on **TCP/IP Connection 1** or **TCP/IP Connection 2** and select **Properties** to make TCP/IP settings. **TCP/IP Connection 2** is not available for E1012 and E1022.

## Modem

Refer to the section *Modem Connection* for information.

## Transparent Mode

Refer to the section *Transparent Mode* for information.

## X-KeyNet

X-Key 16, the extended function keyboard for the E1000 operator panels, is configured under the X-KeyNet icon. For a brief description, see section *Extended Function Keyboard*. Not available for E1012 and E1022. Please see the manual MA00941A for further information.

---

### Note:

Do not add an X-Key 16 to a serial port in the **Peripherals** window in the project, unless an X-Key 16 is to be connected to the operator panel. Otherwise, a Fatal Application Error might occur.

---

For the E-series operator panels, the extended function keyboard E-Key 16 is available, configured under the E-KeyNet icon. Please see the manual MA00644A for further information.

## Network

The network properties are described in the sections *Network Services*, *Network Accounts* and *Network Communication through Ethernet* (TCP/IP Connections).

## Recipe

Properties for recipe handling are made here. See the chapter *Recipes*.



## I/O Poll Groups

The I/O poll interval groups are used to set individual poll intervals for each group of signals (in ms). Values 0-65535 ms can be stated. If no I/O poll interval group is specified for the signal it will be polled instantaneously. The I/O poll interval group for a signal is specified using the button **I/O** when objects are defined. The button **I/O** is included in all dialogs where a signal can be stated.

Not available for E1012 and E1022. See also the section [The I/O Browser](#).

## Runtime Fonts

Runtime Fonts are fonts attributes and effects for menus, e.g. system texts, and input dialogs, e.g. the alphanumeric keyboard in touch screen models, in the operator panel when it is running. Not available for E1012 and E1022. Forms are not applicable for the E1000-series.

## 3.23 The Block Manager menu

The Block Manager menu is available when the Block Manager is activated/ displayed. The functions in the **Block Manager** menu correspond to those in *The Block Manager Toolbar*.

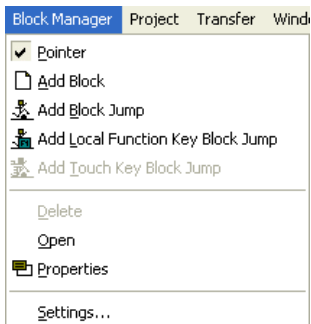

### Properties for the Block Manager

Properties for presentation in the Block Manager can be made under **Block Manager/Settings**, or by right-clicking on the Block Manager and selecting **Settings**.

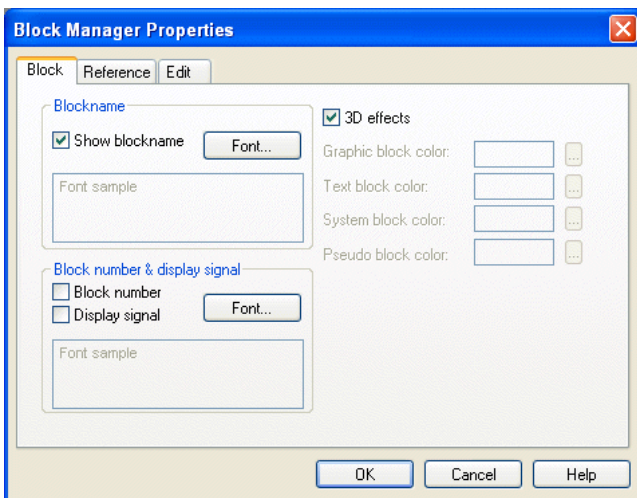

#### Block

Select how data for the block is to be presented, including the layout of the Block Manager, under the **Block** tab.

#### Reference

Select overview layout for the Block Manager under the **Reference** tab.

#### Edit

Select special functions for the presentation in the Block Manager under the **Edit** tab.

## 3.24 The Object menu

The **Object** menu is displayed when a block is opened, and includes all objects available for the block. The number of objects varies depending on the type of operator panel. See description of each object in the chapters *Graphic Presentation and Maneuvering* and *Text-based Presentation for Printouts and Reports*.

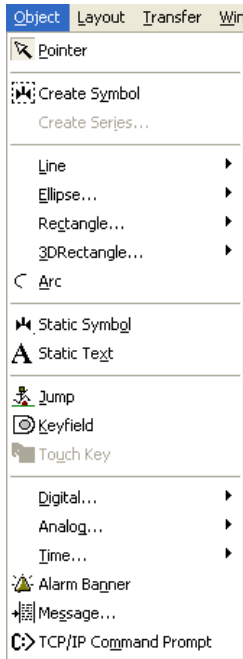

## 3.25 The Layout Menu

The **Layout** menu is displayed when a block is opened and includes functions to adapt and adjust the objects, also available from [The Alignment Toolbar](#) and [The Layout Toolbar](#).

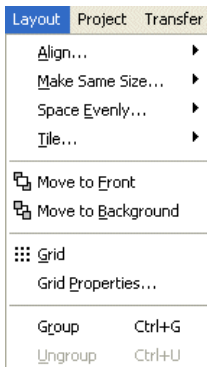

## 3.26 The Project Menu

The **Project** menu provides functions for testing the project and changing project properties, as well as a function for simulating the project.

### The Simulator

The Simulator is used to run the project on a personal computer. Save the project and select **Project/Run**. Now, a new window is shown, acting as the operator panel. Press **Esc** to end the simulator and return to the configuration tool.

## 3.27 The Transfer Menu

The **Transfer** menu provides functions for transferring projects or selected blocks, and communication properties for transfer between the PC and the operator panel. See the chapter [Project Transfer](#) for information.

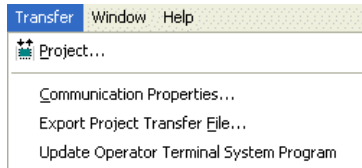

The function **Export Project Transfer File** is used to export projects to a format used by Compact Flash cards and USB Flash drives for temporary storage.

### Note:

Use of Compact Flash cards is not supported in the E1012, E1022, E1032, E1041, E1043, E1060, E1061, E1062 and E1063 operator panels.

This function can be useful for moving projects between operator panels when performing project updates, for example. For more information, see the chapter [Project Transfer](#).

## 3.28 The Window Menu

Properties for how program windows are to appear in the configuration tool are made from the **Window** menu.

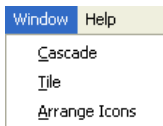

## 3.29 The Help Menu

Via the **Help** menu, help texts for the configuration tool as well as for the controller can be displayed. Additionally, program version information is available, and showing the Tip of the Day can be turned on or off





## 4 Graphic Presentation and Maneuvering

This chapter presents the graphic objects in tabular form and then describes each object separately.

### 4.1 General Parameters

The Properties dialog for the selected object is displayed by double-clicking on the object on the working area. Some properties are not available for all operator panel models.

#### The General Tab

The properties under the **General** tab vary for the different objects, and are described for each object.

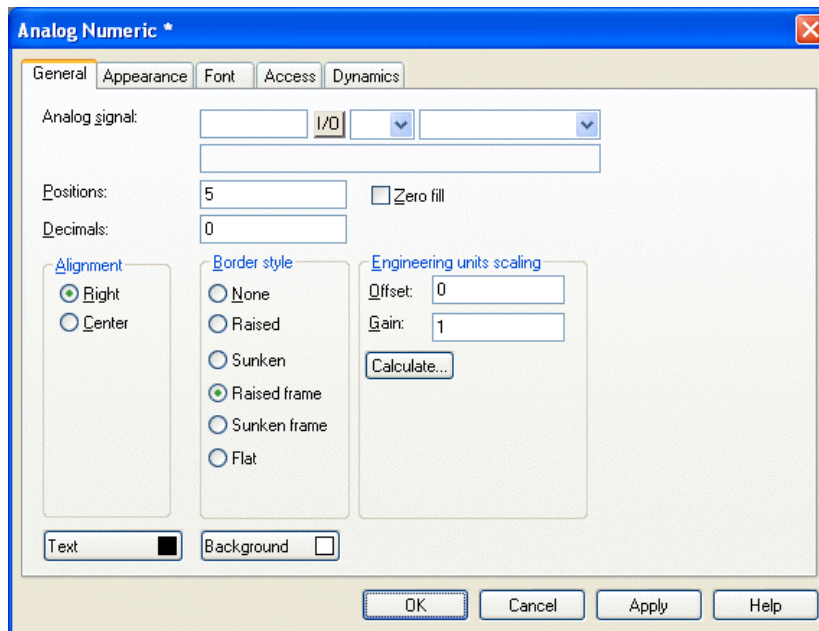

All dynamic objects can be connected to a digital or analog signal.

### Engineering units scaling

The parameters **Offset** and **Gain** are used to change the scale of the controller value to a value shown in accordance with the following equation.

$$\text{Panel value} = \text{Offset} + \text{Gain} * \text{Controller value}$$

When the value for an object is changed from the operator panel, the scale is changed to the value shown in accordance with the following equation:

$$\text{Controller value} = (\text{Panel value} - \text{Offset}) / \text{Gain}$$

Scaling does not affect the defined maximum and minimum values, or the number of decimal places.

### Offset Gain Calculation

The function **Offset Gain** calculation is a tool to calculate the offset and gain parameters. Specify the value of **Offset** and **Gain** under the **General** tab for the object and click on **Calculate** to display the following dialog.

Input		
	Lower	Upper
Controller value range:	-32768	32767
Panel value range:	-32768	32767

Output	
Calculated offset:	0
Calculated gain:	1

Enter the range for the controller value and panel value. The correct values for the parameters **Offset** and **Gain** are calculated.



## The Appearance Tab

The properties under the **Appearance** tab vary slightly between different objects. The **Appearance** tab is not available for E1012, E1022 and E1032.

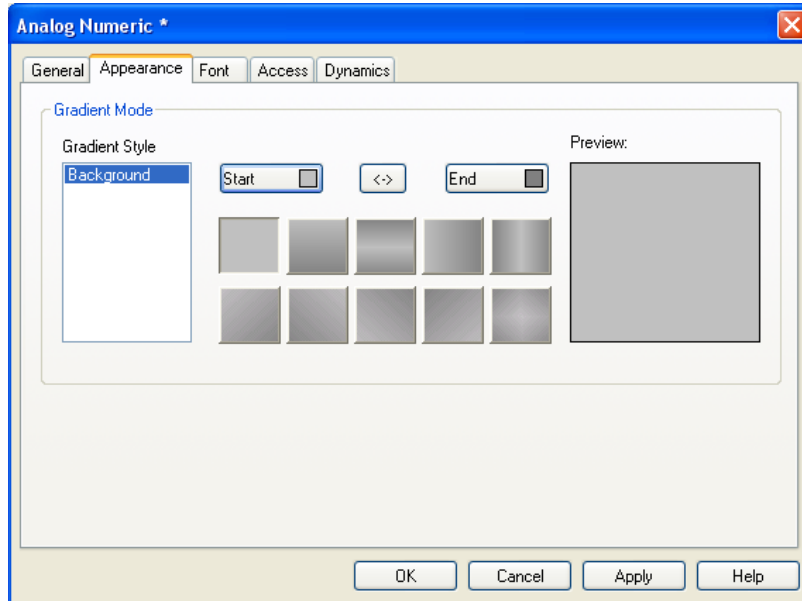

The operator panels with color display support using 64K colors for objects and bit-map images. E1043, E1062 and E1063 support using 16 grayscales. The E1032 has a black&white display.

Colors allow more realistic objects with 3D effects and shadowing to be created. Apart from background and foreground colors for the blocks, different gradient styles for objects can also be selected. Additionally, it is possible to select colors for scales, curves etc. in graphic objects.

Clicking the **Start**- and **End**-buttons opens the Color Palette, where also custom colors can be defined. Clicking the <->-button inverts the coloring for the gradient style. Click on the different buttons with gradient styles to find a style that suits your preferences. The result is displayed in the **Preview**-window.

## The Font Tab

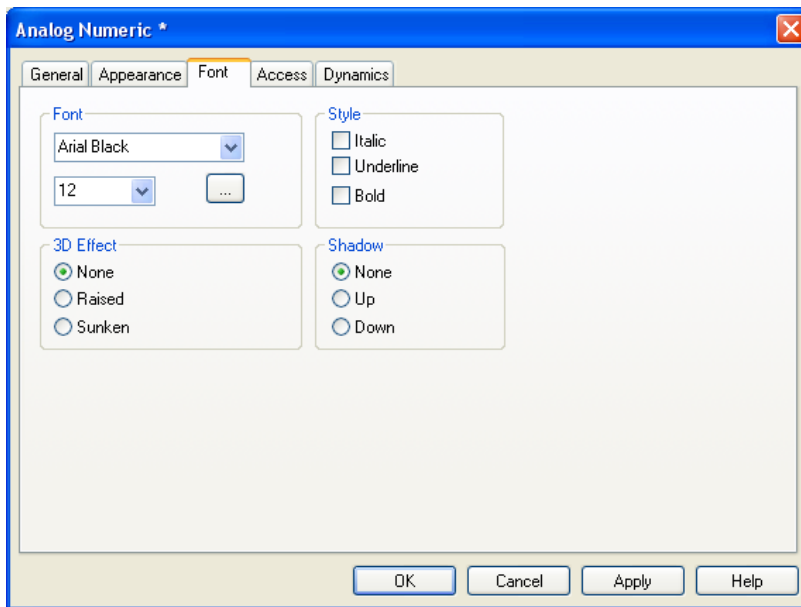

### Font

Select a font and a font size from the drop-down menus. Alternatively, click the ...-button to make a selection from the Windows fonts dialog. For E1012 and E1022 only fixed or resizable fonts can be selected.

### Style

An italic, underlined or bold style can be selected for the text. The style stays regular if all the boxes are left unchecked. Only available for E1012 and E1022 if resizable fonts are selected.

### 3D Effect

A 3D effect for the text can be selected. Not available for E1012 and E1022.

### Shadow

A shadowing of the text can be selected. Not available for E1012 and E1022.

## The Access Tab

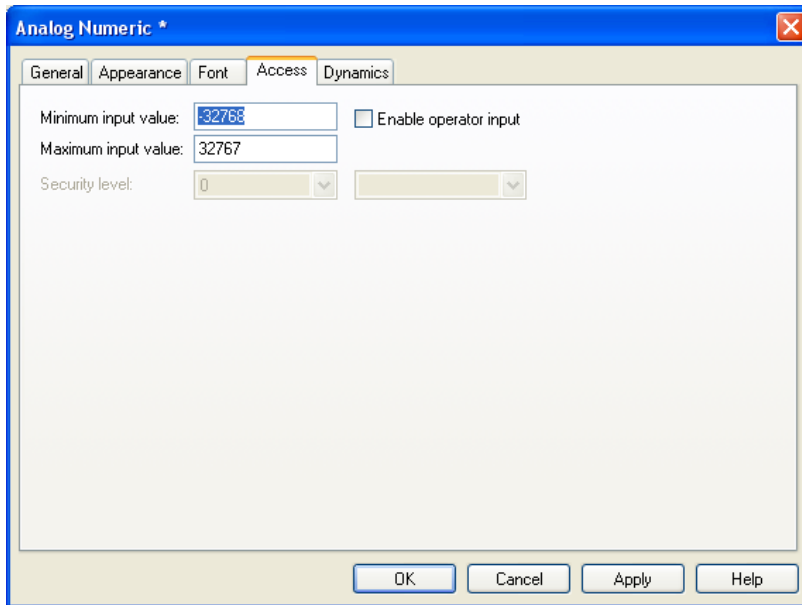

The **Minimum** and **Maximum input value** for the object is specified under the **Access** tab. Checking **Enable operator input** makes the object maneuverable for the operator, according to the specified security level. Security levels can be defined by double-clicking the **Password** folder in the Project Manager. See the chapter [Passwords](#) for further information.

## Dynamics

Dynamics increases the number of signals that must be updated in the block, which affects the updating time for the block. The dynamic functions are described below.

### Property

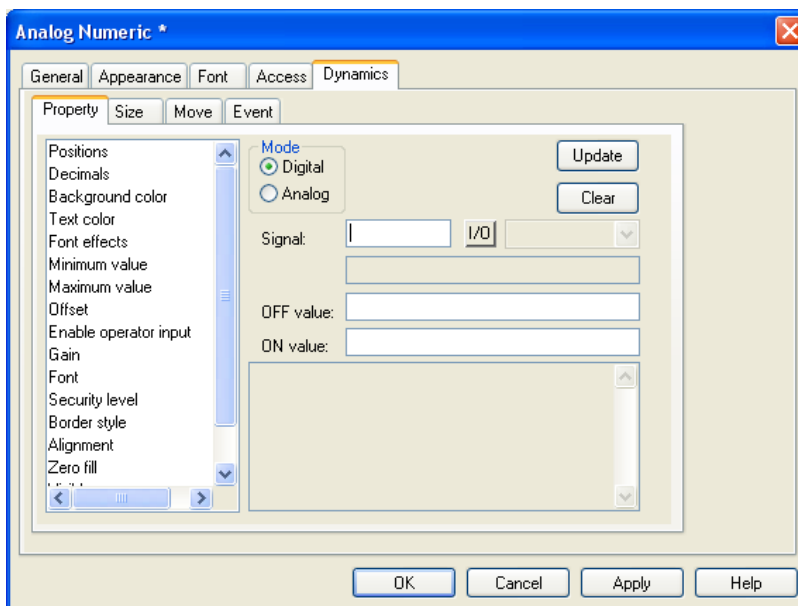

Specify a signal to control a property under the **Property** tab. You can select digital or analog control.

Select a property to be controlled by the controller from the list. The property can only be used once per object/signal. A used property is marked in red. Enter a signal or click on the button **I/O** to select the signal using the I/O Browser.

For digital signals, **OFF** and **ON** values can be specified. If no OFF/ON values are given, the OFF value is set to 0 and the ON value to 1.

For analog signals, the length can be specified if the format is of the type string.

---

#### Note:

If analog controlling is selected for a property which can only assume digital values, On and Off, the property will be On as long as the signal does not have the value 0.

---

#### Note:

In order to be able to influence **Offset/Gain** in an object, offset/gain must be defined to something other than 0/1 in the object from the beginning.

---

## Size

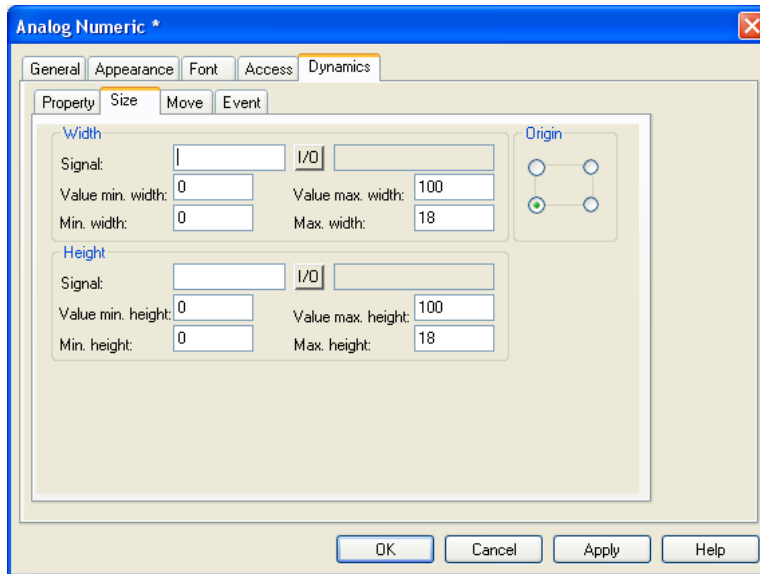

Values for **Width**, **Height** and **Origin** can be entered under the **Size** tab. Two analog signals are defined, where the value of the signals determines the size of the object in X-axis (width) and Y-axis (height).

---

### Note:

If an unreasonable value is given, e.g. a value which means that the object cannot be drawn on the display, the value will be ignored.

---

### Signal

Specify an analog signal.

### Value min. width/height

Specify the analog signal's minimum value.

### Value max. width/height

Specify the analog signal's maximum value.

### Min. width/height

Specify the object's minimum width/height in pixels when the **Minimum value** = defined value.

### Max. width/height

Specify the object's maximum width/height in pixels when the **Minimum value** = defined value.

### Origin

You select the starting point for the object when it is drawn on the display.

## Move

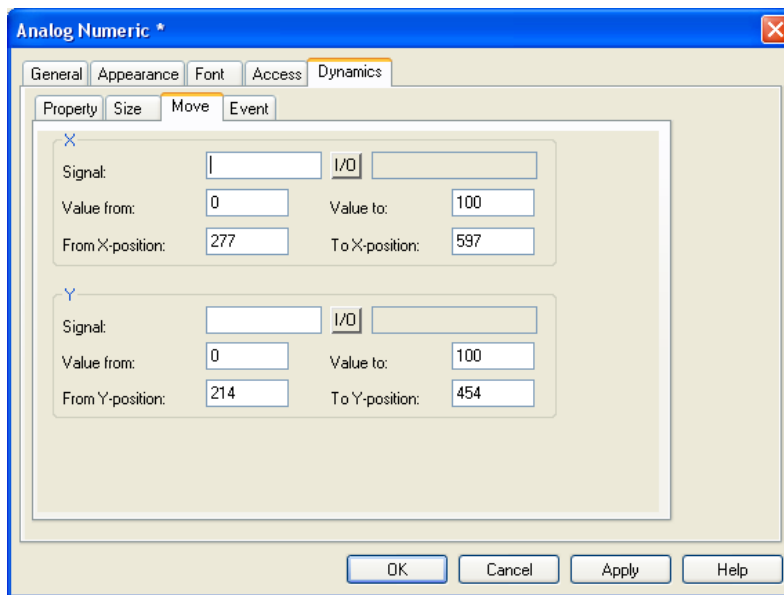

Two analog signals can be specified under the **Move** tab, the values of which correspond to the X- and Y-coordinates (width and height) for the object.

---

### Note:

If an unreasonable value is given, e.g. a value which means that the object cannot be drawn on the display, the value will be ignored.

---

### Signal

Specify an analog signal.

### Value from

Specify the analog signal's minimum value.

### Value to

Specify the analog signal's maximum value.

### From X-/Y-position

Specify the object's X- and Y-coordinates, i.e. the pixel value on the display, when the value in the parameter **Value from** = defined value.

### To X-/Y-position

Specify the object's X- and Y-coordinates, i.e. the pixel value on the display, when the value in the parameter **Value to** = defined value.

---

### Note:

The property **Visible** must not be used together with the property **Positions**.

---

## Event

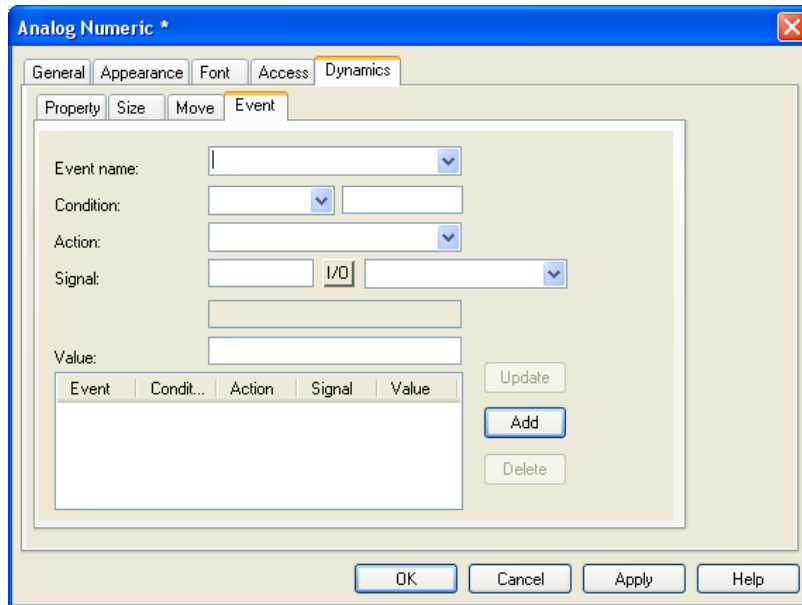

Under **Event** the following parameters can be specified. Existing events can be updated, new events can be added, and events can be deleted using the buttons in the dialog.

### Event name

Select an optional event name from the list.

### Condition

Select one of the following conditions from the list:

Conditions	Description
Equal to	The event takes place on the given signal when the value of the object is the same as the value defined for the <b>Value</b> parameter. The value must be entered by the operator.
Not equal to	The event takes place on the given signal when the value of the object is NOT the same as the value defined for the <b>Value</b> parameter. The value must be entered by the operator.
Greater than	The event takes place on the given signal when the value of the object is greater than the value defined for the <b>Value</b> parameter. The value must be entered by the operator.
Less than	The event takes place on the given signal when the value of the object is less than the value defined for the <b>Value</b> parameter. The value must be entered by the operator.

**Action**

Select what is to be affected; a digital I/O, an analog I/O, or if a macro is to be run. A maximum of 30 macro events can be linked to the same signal.

**Signal**

Select the signal to be influenced when the condition is fulfilled.

**Value**

Select the value the influenced signal is to assume when the condition is fulfilled.

**Note:**

A maximum of 20 events can be added to an object.









## 4.2 Graphic Objects

### Static/Dynamic Graphic Objects

Static graphic objects are used to draw graphics. Graphic objects can be given dynamic properties under **Dynamics**.

**Note:**

Static objects are always positioned behind dynamic objects during presentation.

Symbol	Object
	Line
	Arc
	Rectangle
	Symbol See section <a href="#">Static Symbols</a> in the chapter Configuration with the configuration tool.
	Static text Maximum length is 64 characters.
	Ellipse
	Key field
	Poly line





## Dynamic Handling of Bitmap

If you check the box **Use dynamic bitmaps** for a static symbol object, the operator panel will collect the specified bitmap file (name.bmp) from the library IMAGES in its file system. The bitmap image is presented on the display when the operator panel is running. The image to be presented must be transferred to the library IMAGES in the operator panel via FTP transfer. It will then be possible via FTP to add, replace, or remove dynamic bitmap images on the display by writing over, entering or deleting bmp files in the library IMAGES. The image for a dynamic bitmap image object is only displayed when the operator panel is running. The bitmap images in the library are not shown in the configuration tool. Not available for E1012 and E1022. See section FTP server in the chapter *Network Functions in the Operator Panel*.





## Dynamic Digital Graphic Objects









Digital graphic objects are always linked to digital signals in the controller.

Symbol	Object	Description
	<i>Digital Text</i>	Switches between two texts depending on the status of a digital signal.
	<i>Digital Symbol</i>	Switches between two symbols depending on the status of a digital signal.
	<i>Digital Fill</i>	Fills a framed area in one or two colors, depending on the status of a digital signal.





## Dynamic Analog Graphic Objects

Analog graphic objects are linked to registers in the controller.

Symbol	Object	Description
	<i>Analog Numeric</i>	Input and presentation of values in numeric form.
	<i>Bar Graph</i>	Presents values in the form of a bar graph.
	<i>Diagram</i>	Displays X/Y diagrams based on the content in data registers.
	<i>VU Meter</i>	Creates a graphic VU meter on the display.
	<i>ASCII</i>	Handles ASCII strings in graphic blocks.

Symbol	Object	Description
	<i>Slide</i>	Enables the value of an analog signal to be increased or decreased.
	<i>Trend</i>	Presents values collected from data registers in curve form.
	<i>Speedometer</i>	Creates a graphic speedometer on the display.
	<i>Analog Fill</i>	Fills a framed area, depending on the value of a register.
	<i>Multiple Symbol</i>	Shows one of up to eight different symbols, depending on the value in a data register. Also allows symbols to be moved over to the display.
	<i>Multiple Choice</i>	Links to a data register, which can assume up to eight different states. A text of up to 30 characters can be linked to each state.
	<i>Message</i>	Shows texts from a message library.
	<i>Analog Numeric Table</i>	Creates a table with numeric objects.

### Other objects

Symbol	Object	Description
	<i>Jump</i>	Creates a jump to another block.
	<i>Alarm Banner</i>	Shows a line from the alarm list.
	<i>Analog Clock</i>	Shows an analog clock.
	<i>Digital Clock</i>	Shows a digital clock.

## Digital Text

The **Digital Text** object is used to switch between two texts, of a maximum of 30 characters, depending on the status of a digital signal.

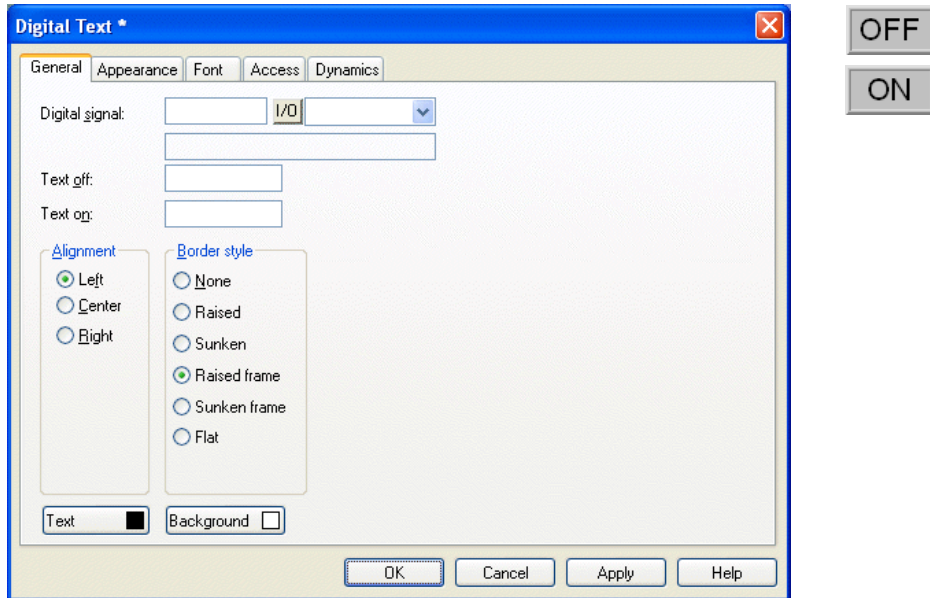

### General

Parameter	Description
Digital signal	The address of the digital signal.
Text off	The text to be shown when the signal is 0.
Text on	The text to be shown when the signal is 1.
Alignment	Select whether the text is to be left-aligned, right-aligned or centered.
Border style	Select whether a frame is to be drawn around the object.
Text*	The color of the text in the object.
Background*	The background color for the object.

\* Not available for E1012, E1022 and E1032.

### Other Tabs

The functions under **Appearance**, **Font**, **Access** and **Dynamics** are described in the section [General Parameters](#).

## Digital Symbol

The **Digital Symbol** object is used to switch between two selected symbols depending on the status of a digital signal.

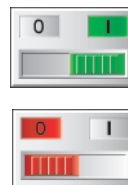
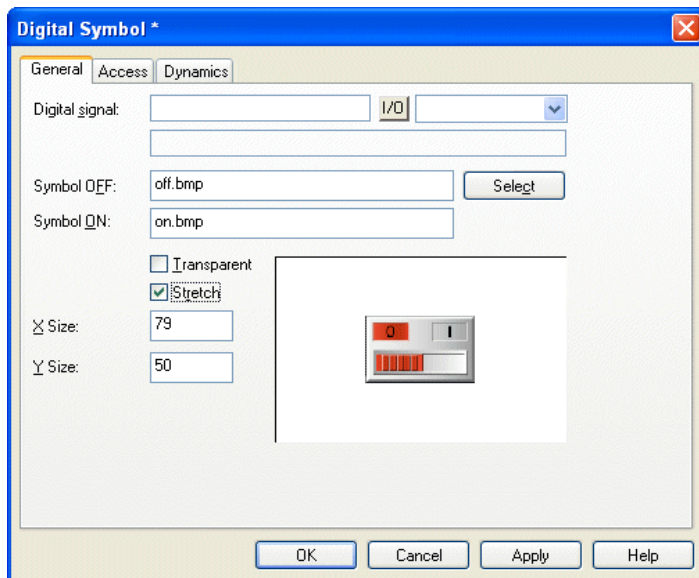

### General

Parameter	Description
Digital signal	Address of the signal.
Symbol OFF	Select the symbol to be shown when the signal is 0.
Symbol ON	Select the symbol to be shown when the signal is 1.
Transparent	Checking the box makes the symbol transparent. The color of the top left pixel in the image controls which color will be transparent. Not available for E1012 and E1022.
Stretch	When selected, the object's X and Y size can be changed, using the X and Y size-boxes, or using the cursor on the working area.

### Other Tabs

The functions under **Access** and **Dynamics** are described in the section [General Parameters](#).

## Digital Fill

The **Digital Fill** object is used to fill a framed area with one of two colors depending on the status of a digital signal.

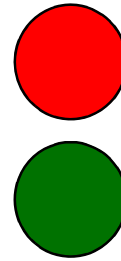
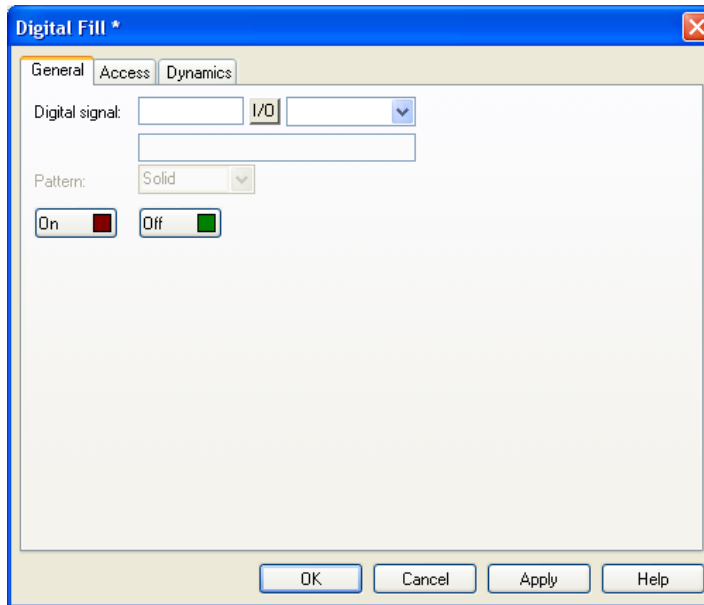

---

### Note:

Filling an excessively irregular area when the operator panel is running can cause system errors. In certain cases filling can slow down the image.

---

### General

Parameter	Description
Digital signal	The address of the digital signal.
Pattern	For E1012, E1022 and E1032, <i>Solid</i> or <i>Dashed</i> is available.
On*	Select color of the object when the signal is 1.
Off*	Select color of the object when the signal is 0.

\* Not available for E1012, E1022 and E1032.

### Other Tabs

The functions under **Access** and **Dynamics** are described in the section [General Parameters](#).

### Positioning of the Object

The program calculates what should be filled in the area. It is therefore important that the object is positioned correctly. Incorrectly positioned objects can result in errors in the application when the operator panel is running. The area to be filled is only limited by static objects and static parts of dynamic objects. Filled objects can be replaced by Digital symbol objects or Multisymbol objects to improve performance in the project.

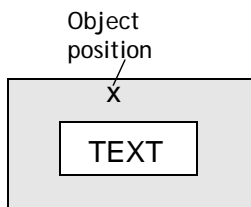

*Correct! Draw a frame round the text in the area to be filled to improve performance in the image.*

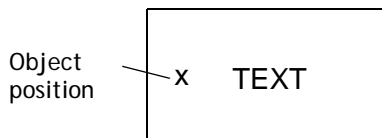

*Incorrect! The image becomes slow since the program has to make a lot of calculations to fill the area between the letters.*



## Jump

The **Jump** object is used to create a jump to another block, to enable a menu hierarchy in the project. By pressing the key [PREV] on the operator panel it is possible to return to previous blocks (nine levels backwards). See the chapter *Function Keys* for further information.

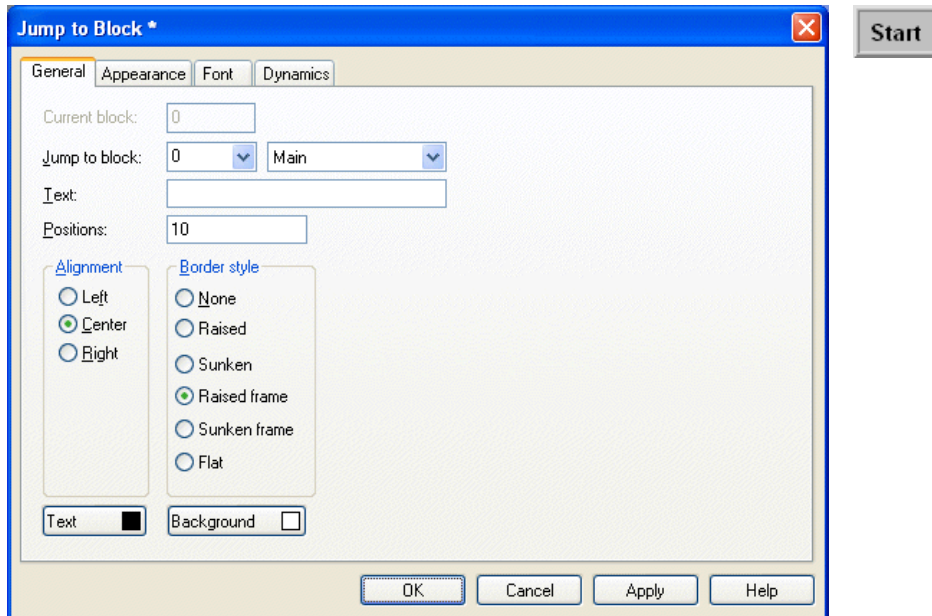

### General

Parameter	Description
Current block	The number of the current block is shown here. Cannot be changed.
Jump to block	The number or name of the block to which the jump is to be made.
Text	An optional text to be shown in the object.
Positions	The maximum number of positions the text is to occupy.
Alignment	Select whether the text is to be left-aligned, right-aligned or centered.
Border style	Select whether a frame is to be drawn around the object.
Text*	The color of the text in the object.
Background*	The background color for the object.

\* Not available for E1012, E1022 and E1032.

---

**Note:**

An error message is displayed if a jump to a block that does not exist is made when the operator panel is running.

---

**Other Tabs**

The functions under **Appearance**, **Font** and **Dynamics** are described in the section *General Parameters*.



## 03 Analog Numeric

The **Analog Numeric** object is used to create an input field and to present values in numeric form.

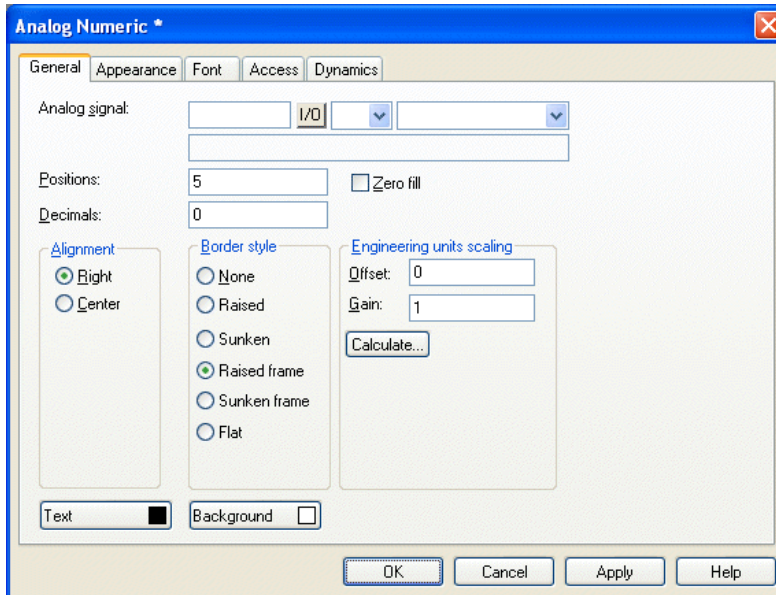

### General

Parameter	Description
Analog signal	The address of the signal.
Positions	The number of positions the entered value should be given, including comma and minus characters.
Zero fill	Select whether zeros are to be written in empty positions.
Decimals	The number of decimals the object is to be presented with.
Alignment	Select whether the input field is to be right-aligned or centered.
Border style	Select whether a frame is to be drawn around the object.
Engineering units scaling	Used to scale register value. See the section <a href="#">General Parameters</a> .
Text*	The color of the text in the object.
Background*	The background color for the object.

\* Not available for E1012, E1022 and E1032.

### Other Tabs

The functions under **Appearance**, **Font**, **Access** and **Dynamics** are described in the section [General Parameters](#).

## Bar Graph

The **Bar Graph** object presents whole or decimal numbers in the form of a bar graph.

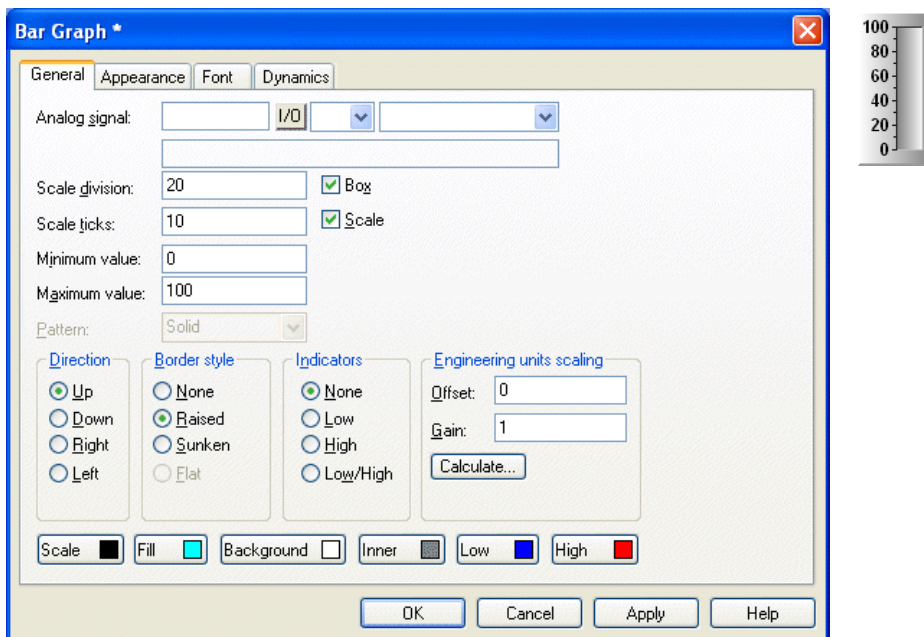

### General

Parameter	Description
Analog signal	The address of the signal.
Scale division	How the scale is to be divided.
Box	Select whether a box is to be drawn around the bar.
Scale ticks	The interval between scale ticks shown.
Scale	Select whether the scale is to be shown on the bar graph.
Minimum value	The minimum value the signal can assume.
Maximum value	The maximum value the signal can assume.
Pattern	For E1012, E1022 and E1032, <i>Solid</i> or <i>Dahsed</i> is available.
Direction	Select whether the bar graph is to be presented to the right, left, upwards or downwards.
Border style	Select whether a frame is to be drawn around the object.

Parameter	Description
Indicators	Select whether the maximum and/or minimum values for the signal are to be shown on the axis. The indicators are reset when the operator panel is started. Resetting can also be carried out in the operator panel by selecting the bar graph and clicking ENTER (pointing to the bar graph touch screen operator panels). The indicators only function for signed 16-bit numbers.
Engineering units scaling	Used to scale the register value. See the section <a href="#">General Parameters</a> .
Scale*	The color of the scale in the object.
Fill*	The fill color.
Background*	The background color for the object.
Inner*	Color of the bar when not filled.
Low*	Indicator color low.
High*	Indicator color high.

\* Not available for E1012, E1022 and E1032.

### Other Tabs

The functions under **Appearance**, **Font** and **Dynamics** are described in the section [General Parameters](#).

## Diagram

The **Diagram** object is used to draw X/Y diagrams based on the contents of controller registers. This is a real-time function. The object is normally used for non-time-based presentations. Time-based displaying with a sample time of <1 second can be shown if the controller handles the collection of data.

In the following example the value in the register 0 has been selected for the first X-coordinate, and the value in the register 10 for the first Y-coordinate. The number of register pairs is set to 4. The table and the figure below illustrate the example.

X-coordinate	Register	Value	Y-coordinate	Register	Value
X0	0	0	Y0	10	11
X1	1	41	Y1	11	40
X2	2	51	Y2	12	85
X3	3	92	Y3	13	62

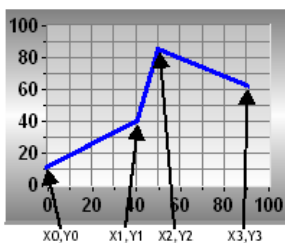

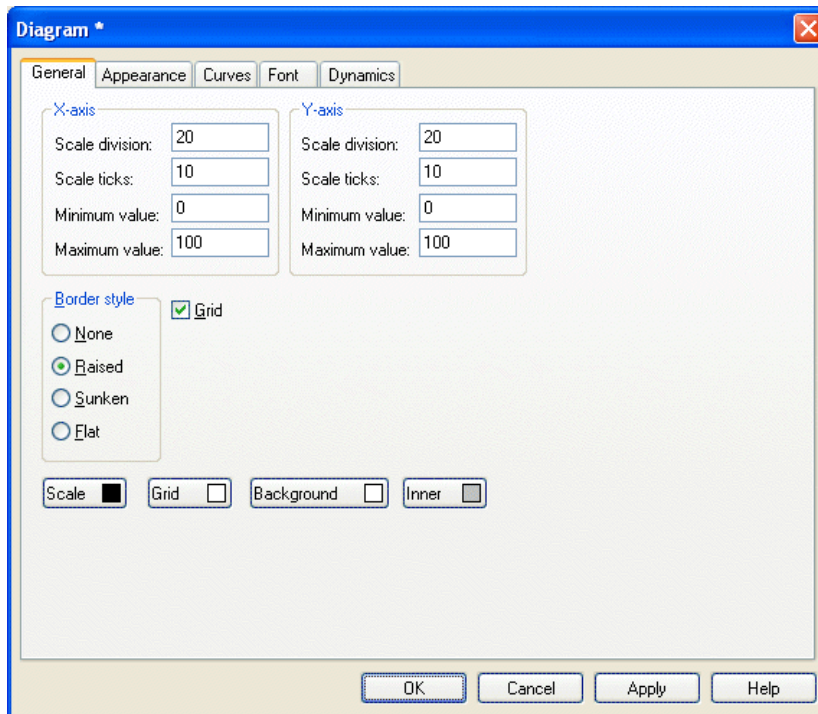

## General

Parameter	Description
Scale division	The interval between scale numbers on the X- and Y-axis.
Scale ticks	The interval between the scale ticks shown on the X- and Y-axis.
Minimum value	The minimum value for the X- and Y-coordinates.
Maximum value	The maximum value for the X- and Y-coordinates.
Border style	Select whether a frame is to be drawn around the object.
Grid	Checking the box shows a grid in the diagram.
Scale*	The color of the scale in the diagram.
Grid*	The color of the grid in the diagram.
Background*	The background color for the object.
Inner*	The inner color for the object.

\* Not available for for E1012, E1022 and E1032.

## Curves

For E1012 and E1022 only one curve is available.

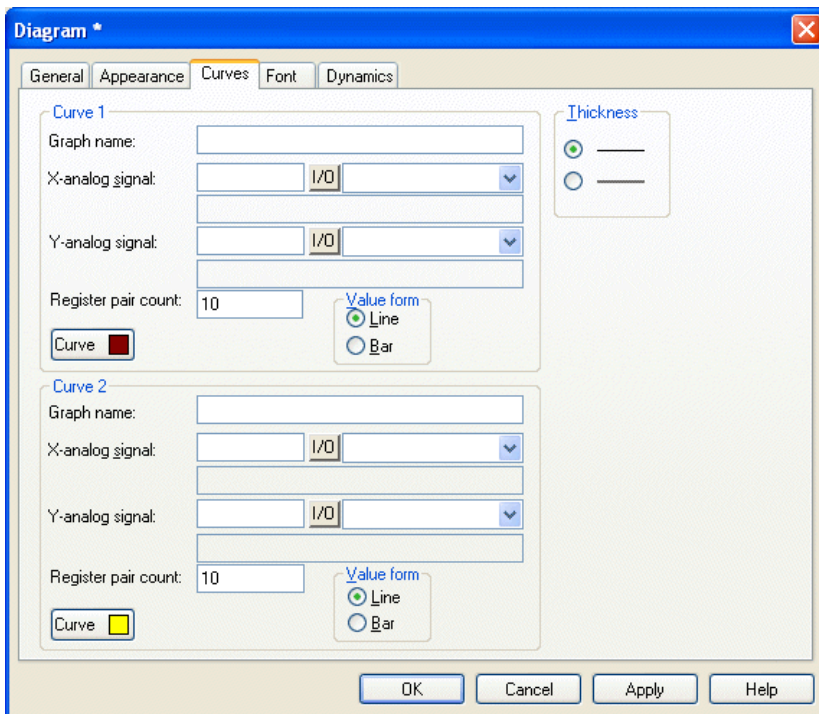

Parameter	Description
Graph name	Specify a name for each curve.
X-analog signal	The data register containing the first X-coordinate for each curve.
Y-analog signal	The data register containing the first Y-coordinate for each curve.
Register pair count	The number of register pairs to be drawn either as dots or bars. A maximum of 49 register pairs can be used.
Value form	Select whether the diagram is to be a bar graph or curve diagram. In the bar graph a bar is drawn for each register pair. In curve diagrams the X-/Y-coordinates are drawn as points between which a line is drawn.
Curve*	The color of each curve.
Thickness*	The thickness of the curve lines.

\* Not available for for E1012, E1022 and E1032.

## Other Tabs

The functions under **Appearance**, **Font** and **Dynamics** are described in the section

[General Parameters](#).

## VU Meter

The **VU Meter** object creates a graphic VU-meter on the display.

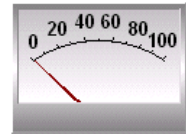
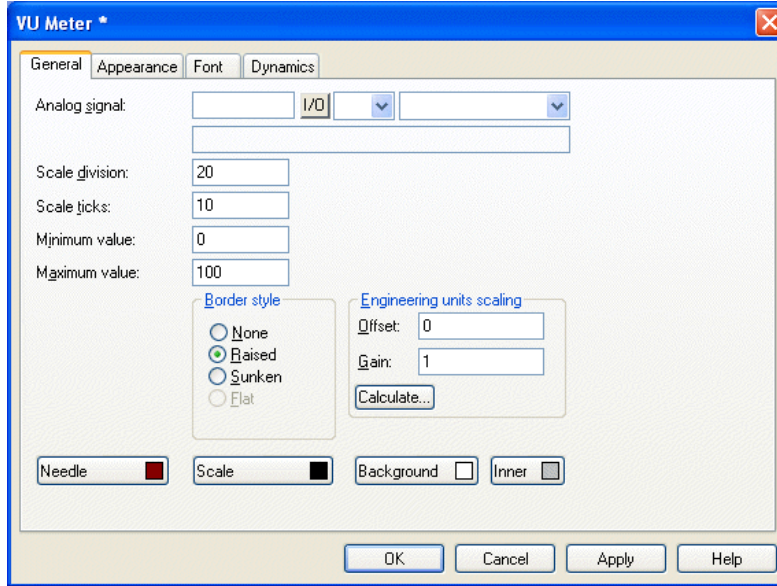

### General

Parameter	Description
Analog signal	Address of the signal.
Scale division	How the scale is to be divided.
Scale ticks	The interval between scale ticks.
Minimum value	The minimum value the signal can assume.
Maximum value	The maximum value the signal can assume.
Border style	Select whether a frame is to be drawn around the object.
Engineering units scaling	Used to scale the register value. See the section <a href="#">General Parameters</a> .
Needle*	The color of the needle in the object.
Scale*	The color of the scale in the object.
Background*	The background color for the object.
Inner*	The inner color of the object.

\* Not available for for E1012, E1022 and E1032.

### Other Tabs

The functions under **Appearance**, **Font** and **Dynamics** are described in the section [General Parameters](#).

## ASCII

The ASCII object handles ASCII strings in graphic blocks. In ASCII objects it is possible to present texts stored in the controller's data register. The texts should be in IBM extended ASCII format or in Unicode format.

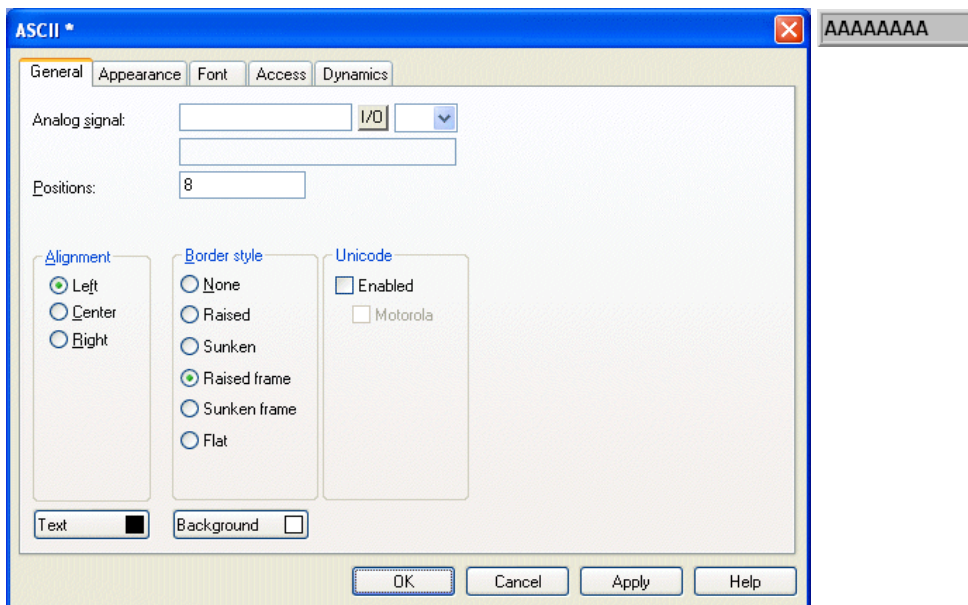

### General

Parameter	Description
Analog signal	The data register where the text for the first position is stored.
Positions	The number of positions the text is to occupy on the display.
Alignment	Select whether the text is to be right-aligned, left-aligned or centered.
Border style	Select whether a frame is to be drawn around the object.
Unicode	Some fonts may require Unicode format. Note that the Unicode format takes up more space than the IBM extended ASCII format. Not available for E1012 and E1022.
Text*	The color of the text in the object.
Background*	The background color for the object.

\* Not available for for E1012, E1022 and E1032.

### Other Tabs

The functions under **Appearance**, **Font**, **Access** and **Dynamics** are described in the section [General Parameters](#).





## Slide

The **Slide** object shows the value of an analog signal in a slider, where the value of the analog signal can be increased or decreased.

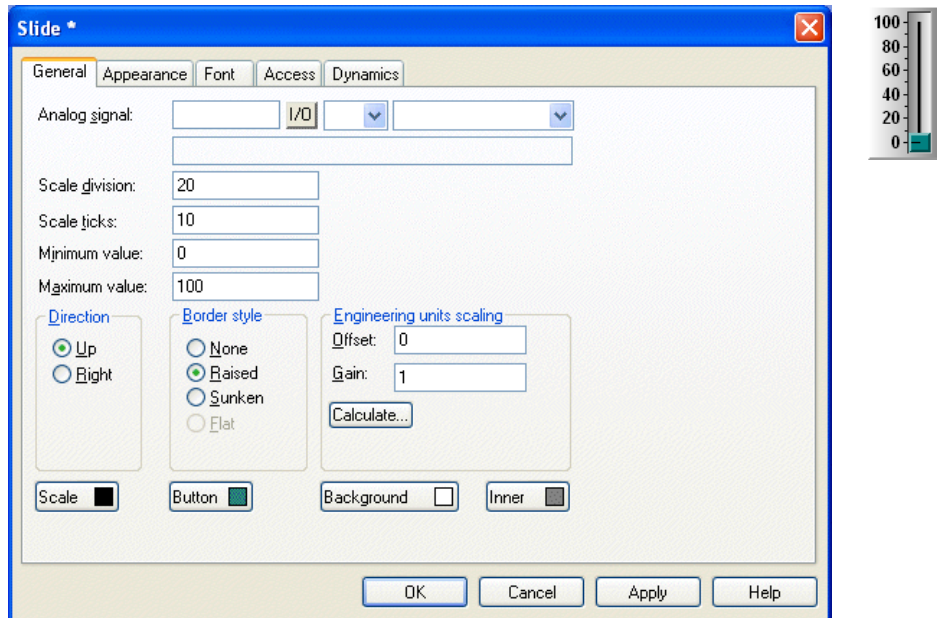

### General

Parameter	Description
Analog signal	The address of the signal.
Scale division	How the scale is to be divided.
Scale ticks	The interval between scale ticks.
Minimum value	The minimum value the object can assume.
Maximum value	The maximum value the object can assume.
Direction	Select whether the slider is to be presented vertically or to the right.
Border style	Select whether a frame is to be drawn around the object.
Engineering units scaling	Used to scale register value. See the section <a href="#">General Parameters</a> .
Scale*	The color of the scale.
Button*	The color of the indicator button.

Parameter	Description
Background*	The background color of the slider.
Inner*	The inner color of the slider.

\* Not available for for E1012, E1022 and E1032.

---

**Note:**

The data type formats BCD float and Float without exponents cannot be used in slider objects.

---

**Other Tabs**

The functions under **Appearance**, **Font**, **Access** and **Dynamics** are described in the section [General Parameters](#).



## Trend

The **Trend** object presents values collected from analog signals. See the chapter [Trends](#) for information.

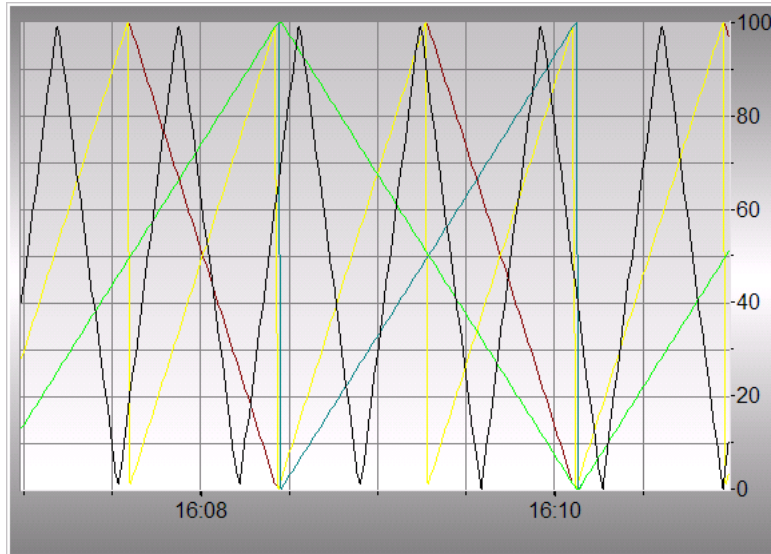

## Speedometer

The **Speedometer** object creates a graphic speedometer on the display. Not available for E1012.

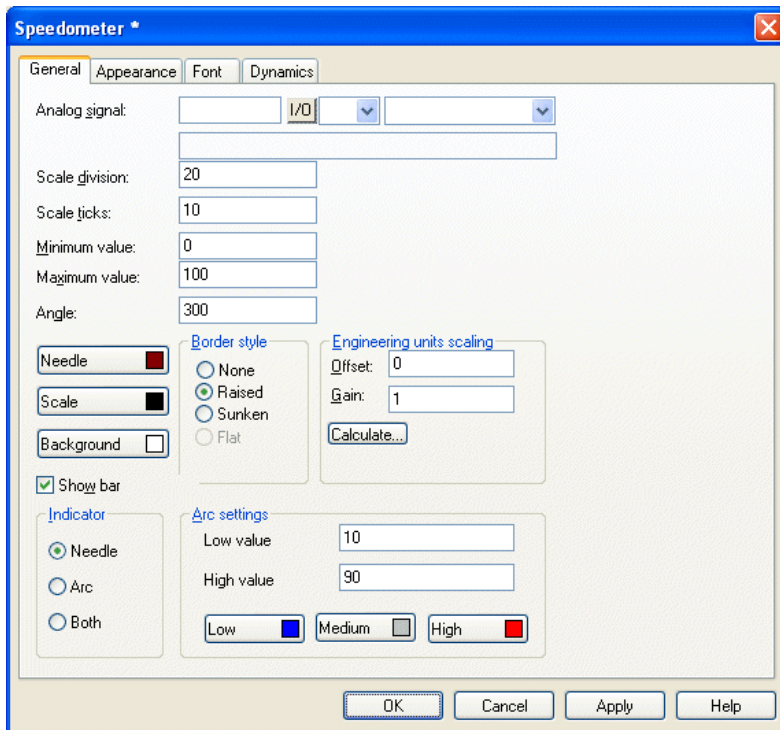

### General

Parameter	Description
Analog signal	Address of the signal.
Scale division	How the scale is to be divided.
Scale ticks	The interval between scale ticks.
Minimum value	The minimum value the speedometer can show.
Maximum value	The maximum value the speedometer can show.
Angle	The angle (working area) for the object. 10 -360 degrees.
Engineering units scaling	Used to scale register value. See the section <a href="#">General Parameters</a> .
Border style	Select whether a frame is to be drawn around the speedometer.

Parameter	Description
Needle*	The color of the needle.
Scale*	The color of the scale.
Background*	The background color of the speedometer.
Show bar*	When selected, an arc is shown around the speedometer. It is possible to change the properties when selected.
Indicator*	Select to show Needle, Arc or Both.
Arc settings*	Low and High value, and the colors to be shown for the different intervals.

\* Not available for E1022 and E1032.

### Other Tabs

The functions under **Appearance**, **Font** and **Dynamics** are described in the section [General Parameters](#).



## Alarm Banner

The **Alarm Banner** object displays a line from the alarm list. See chapter [Alarm Management](#) for more information.

AAAAAAAAAAAAAAAA

## Analog Fill

The **Analog Fill** object fills in a framed area with a color, depending on the value of a register. Not available for E1012, E1022 and E1032. The colors are determined in accordance with the following table:

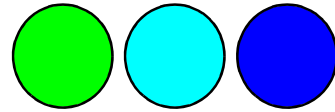
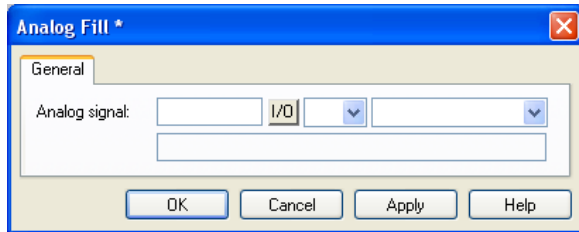

Parameter	Description
Analog signal	The data register, the value of which determines the color of the object. See table below.

Register value	Color	Register value	Color
0	Black	8	Grey
1	Blue	9	Light blue
2	Green	10	Light green
3	Cyan	11	Light cyan
4	Red	12	Light red
5	Magenta	13	Light magenta
6	Yellow	14	Light yellow
7	Light grey	15	White

For E1043, E1062 and E1063 16 grayscales can be used. The register value 0 represents black color, and the register value 15 represents white color. The register values 1-14 represent different shades of gray.

For limitations and positioning of the object, refer to the section [Digital Fill](#).

## Analog Clock

The **Analog Clock** object is used to present an analog clock.

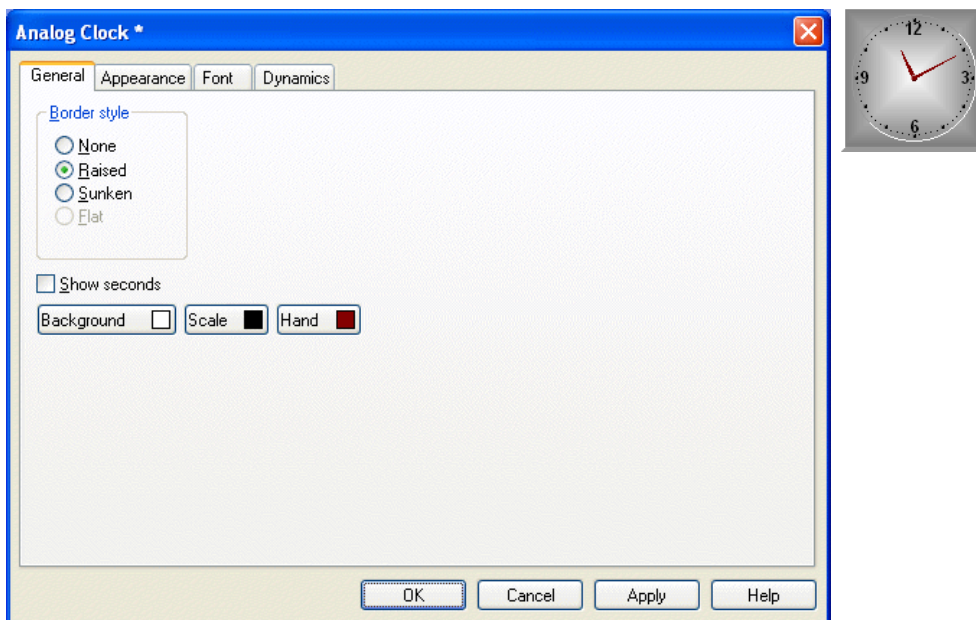

### General

Parameter	Description
Border style	Select whether the clock is to be shown with a frame.
Show seconds	Select whether the clock is to be shown with a seconds hand.
Background*	The background color of the clock.
Scale*	The color of the scale.
Hand*	The color of the hands.

\* Not available for E1012, E1022 and E1032.

### Other Tabs

The functions under **Appearance**, **Font** and **Dynamics** are described in the section [General Parameters](#).



## 8:05 Digital Clock

The **Digital Clock** can be used to present a digital clock, day of the week and date.

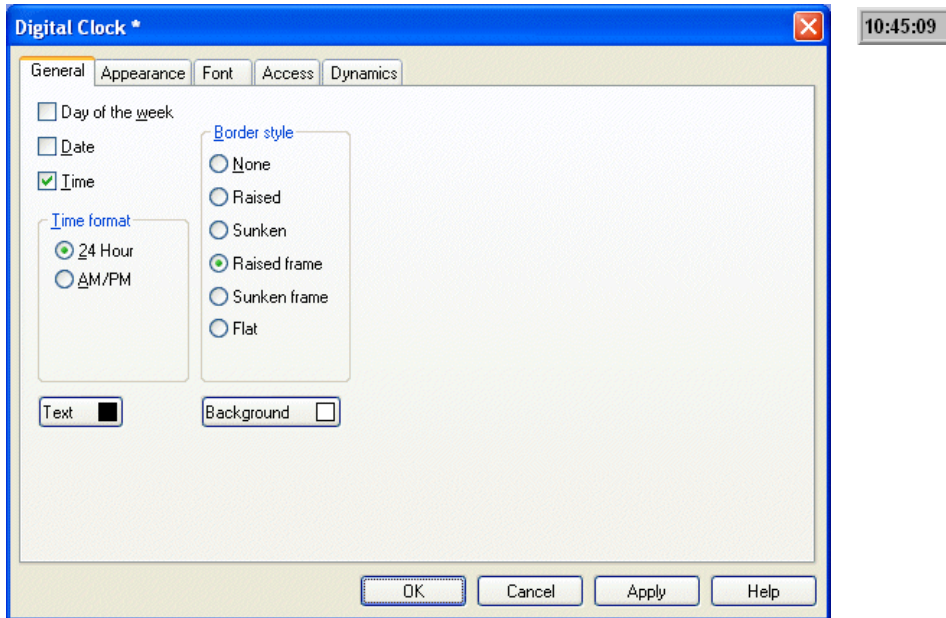

### General

Parameter	Description
Day of the week	Select whether the day of the week is to be shown.
Date	Select whether the date is to be shown.
Time	Select whether the time is to be shown.
Time format	The time can be presented in the 24 hours or AM/PM format.
Border style	Select whether a frame is to be drawn around the object.
Text*	The color of the text.
Background*	The background color of the digital clock.

\* Not available for for E1012, E1022 and E1032.

### Other Tabs

The functions under **Appearance**, **Font**, **Access** and **Dynamics** are described in the section [General Parameters](#).

#### Note:

To set the operator panel clock in the operator panel a maneuverable Date/Time object (Digital clock) must be defined.



## Multiple Symbol

The **Multiple Symbol** object can show one of up to 16 different symbols, depending on the value in a data register. For E1012 and E1022 up to 8 symbols can be selected.

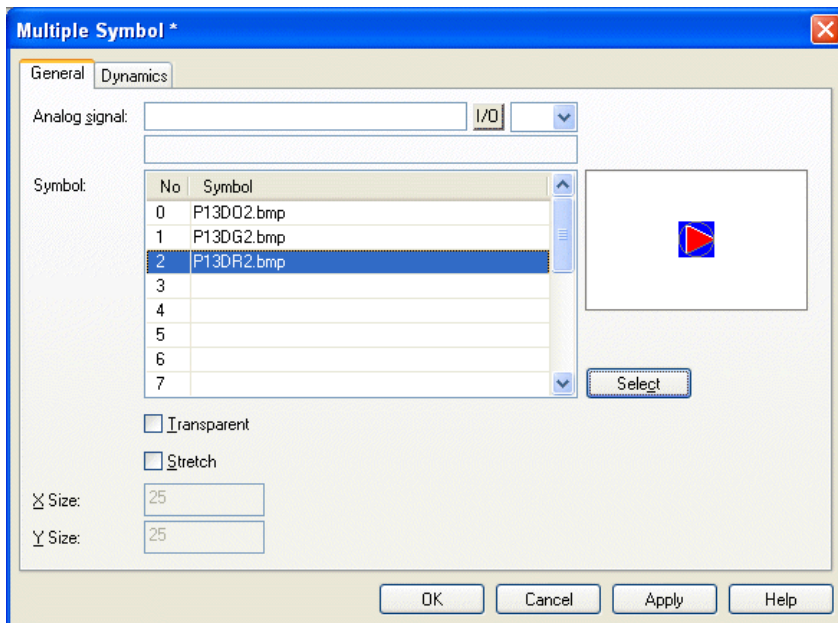

### General

Parameter	Description
Analog signal	Data register that determines which symbol is to be shown. If the register contains the value 1, the symbol 1 will be shown, etc.
Symbol 0-15	Select which symbol to show for each register value.

**Transparent** is not available for E1012 and E1022.

### Dynamics

The functions under **Dynamics** are described in the section [General Parameters](#).

## Multiple Choice

The **Multiple Choice** object can show one of up to eight different texts, depending on the value of a data register. The texts can contain a maximum of 30 characters.

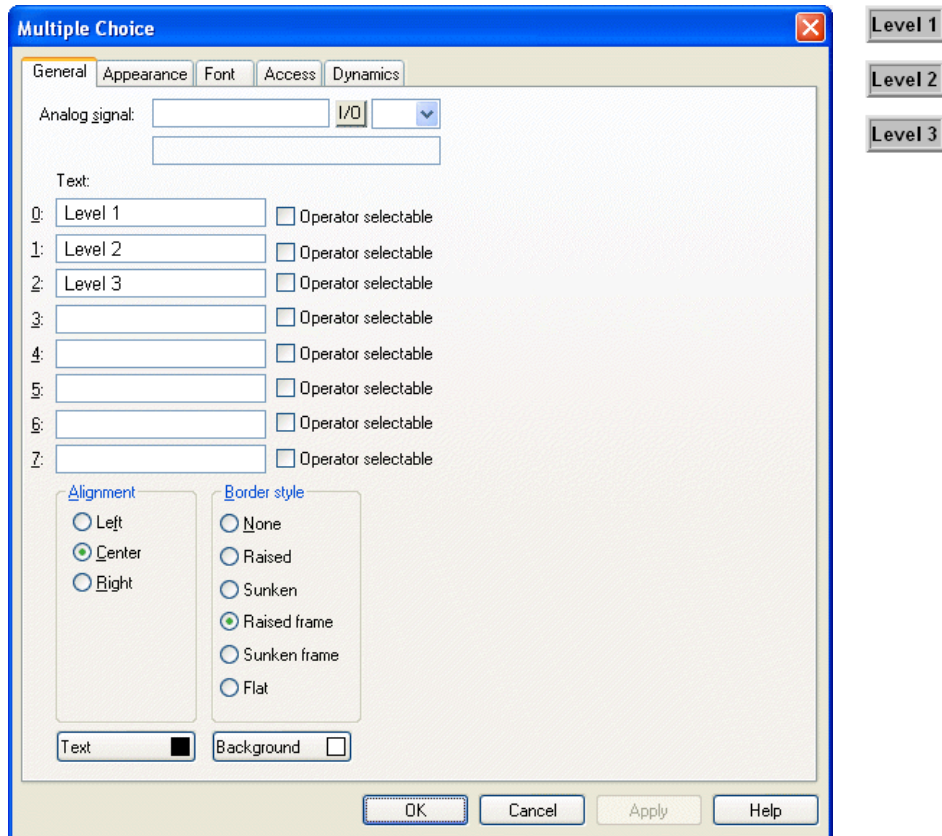

### General

Parameter	Description
Analog signal	The data register that determines which text is to be shown. If the register contains the value 1, text 1 will be shown, etc.
Text 0-7	Type a text to show for each register value.
Operator selectable 0-7	When checked, the operator can select this text when the operator panel is running.
Alignment	Select whether the text is to be left-aligned, right-aligned or centered.
Border style	Select whether a frame is to be drawn around the object.

Parameter	Description
Text*	The color of the text.
Background*	The background color of the multiple choice object.

\* Not available for for E1012, E1022 and E1032.

### **Others**

The functions under **Appearance**, **Font**, **Access** and **Dynamics** are described in the section *General Parameters*.

## Touch Key

Only applicable for the E1041, E1043, E1061, E1063, E1071, E1101 and E1151 operator panels. See the section *Maneuvering Objects Using the Touch Screen* and the chapter *Function Keys*.

The **Touch Key** object is a pressure-sensitive surface with functions similar to those for a function key. It can be used to change images and control memory cells, etc. Up to five rows of text can be used together with a symbol when creating touch keys.

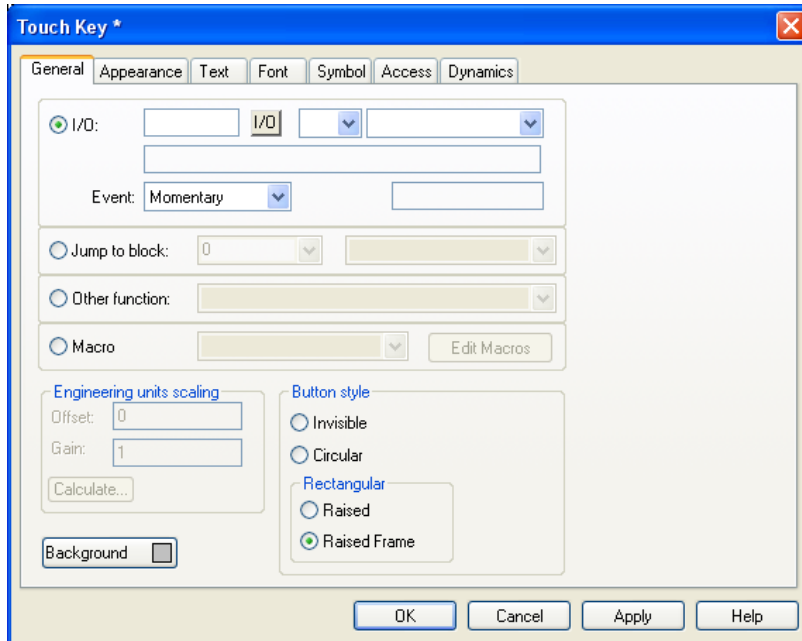

### General

Parameter	Description
I/O	Signal to be influenced when pressing the touch key.

Parameter	Description
Event	How the signal is to be influenced by the touch key. <b>Set</b> means that the signal is set high when the touch key is pressed. <b>Grouped</b> means that all signals, except the one activated, belonging to a touch key with the relevant group number are reset. The group number is given under <b>Group</b> . A maximum of 8 touch keys can be included in a group. <b>Decrements analog</b> means that the analog signal linked to the touch key will decrease its value by the value given under <b>Value</b> . <b>Momentary</b> means that the signal is set high as long as the touch key is pressed. <b>Reset</b> means that the signal is set low when the touch key is pressed. <b>Sets analog</b> means that the analog signal linked to the touch key is allocated the value given under <b>Value</b> . <b>Toggle</b> means that the signal is alternately set high or low when the touch key is pressed. <b>Increments Analog</b> means that the analog signal linked to the touch key will increase its value by the value given under <b>Value</b> . <b>Inputs analog</b> can be used to affect an analog object. A touch keyboard is displayed where the value can be entered.
Jump to block	Jumps to another block when the touch key is pressed. State the number or name of the block to which the jump is to be made.
Other function	For a description of these functions, see the chapter <a href="#">Function Keys</a> .
Macro	For a description of macros, see the chapter <a href="#">Macros</a> .
Button style	Type of button: circular, rectangular or invisible.
Background	The background color of the touch key.

An invisible, pressure-sensitive surface can be used to define the area for block changes in an overview image, e.g. a machine. The detailed images are linked to invisible, pressure-sensitive surfaces placed on selected parts of the machine. The detailed image is shown when the operator clicks on one of these surfaces.

### Text

A maximum of five rows of text, with a maximum of 40 characters/row, can be entered. The placement of the text can be adjusted. The font size stays intact even if the size of the touch key is changed.

### Symbol

A symbol can be selected to enhance the touch key. The placement of the symbol can be adjusted. Selecting **Stretch** under the **Symbol** tab will make the symbol fill the touch key entirely.

### Other Tabs

The functions under **Appearance**, **Font**, **Access** and **Dynamics** are described in the section [General Parameters](#).

## Message

The **Message** object presents texts from message libraries.

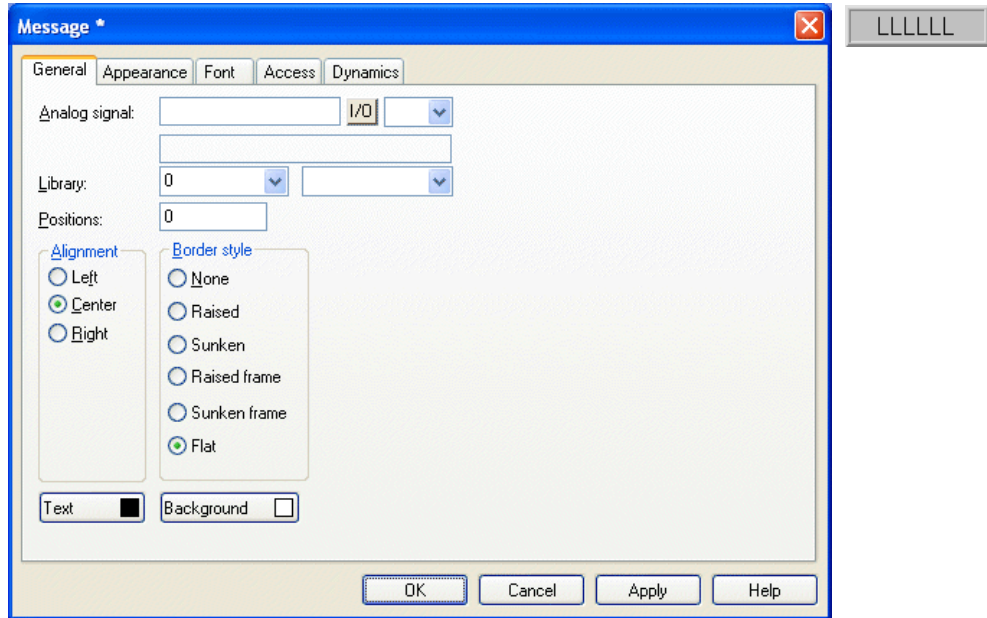

### General

Parameter	Description
Analog signal	Analog signal that controls which text selected from message libraries is to be shown.
Library	The number of the required message library. Defined under <b>Functions/Message Library</b> .
Positions	The number of positions the text is to be presented with. 0 = automatic length adjusting.
Alignment	Select whether the text is to be left-aligned, right-aligned or centered.
Border style	Select whether the text is to be shown with a frame.
Text*	The color of the text.
Background*	The background color of the message object.

\* Not available for for E1012, E1022 and E1032.

### **Access**

The required **Input range** area is set under the **Access** tab. An area of a maximum of 64 texts can be maneuvered in the operator panel. State the number of the first and last text in the area.

---

#### **Note:**

The number of positions should not be 0 when the function Library index register is used. See the section [Library index register](#).

---

For further information, see the chapter [Message Library](#).

### **Other Tabs**

The functions under **Appearance**, **Font** and **Dynamics** are described in the section [General Parameters](#).



## Analog Numeric Table

The **Analog Numeric Table** object is used to create a table of analog numeric objects. Not available for E1012 and E1022.

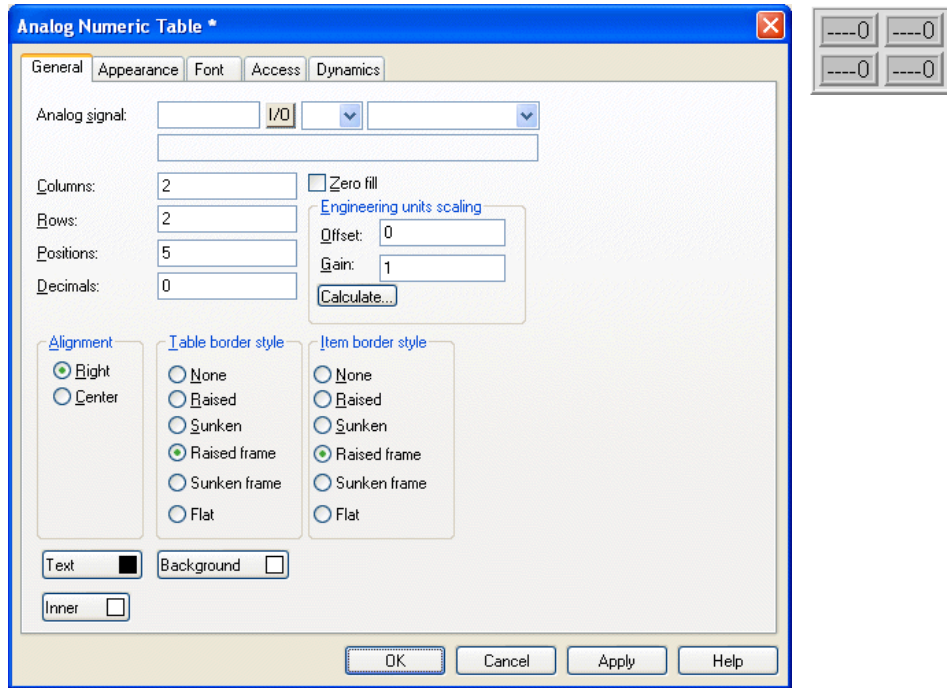

### General

Parameter	Description
Analog signal	The first signal to be presented in the table. Only 16-bit registers are supported.
Columns	The number of columns in the table.
Zero fill	Select whether zeros are to be written in empty positions.
Rows	The number of rows in the table.
Positions	The number of positions the entered value should be given.
Decimals	The number of decimals the entered value should be given.
Alignment	Select whether the input field is to be right-aligned or centered.
Table border style	Select whether a frame is to be drawn around the table.
Item border style	Select whether a frame is to be drawn around each separate cell in the table.

Parameter	Description
Text*	The color of the text.
Background*	The background color of the analog numeric table.
Inner*	The inner color of the analog numeric table.
Engineering units scaling	Used to scale register values. See the section <a href="#">General Parameters</a> .

\* Not available for E1032.

### Access

The input direction of the table is specified under **Access**. The signals in the table are calculated according to the given direction.

### Other Tabs

The functions under **Appearance**, **Font** and **Dynamics** are described in the section [General Parameters](#).

---

#### Note:

The minimum and maximum value are only used when the object is maneuverable.

---

## 4.3 Maneuvering Graphic Blocks Using the Key Pad

Step between the maneuverable objects with the arrow keys. Selected objects are highlighted with a blinking frame.

### Select Maneuverable Objects

The arrow keys are used to jump between maneuverable objects. Objects are selected according to the following principle: The position of the cursor is assumed to be the centre of a cross. When pressing the right arrow, the first object found in area A according to the diagram below will be selected. If the system cannot find an object in the narrow field to the right it will search in area a. The down arrow searches in area B and b, the left arrow in area C and c, and the up arrow in area D and d.

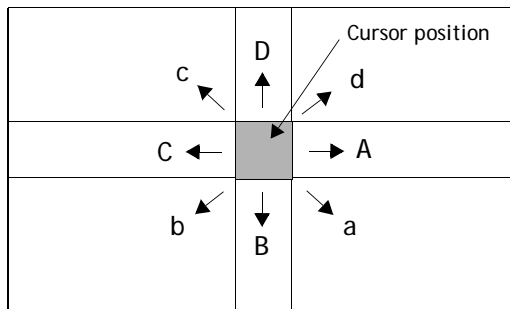

### Operate Digital Objects

Digital objects; text, symbol and filled objects, switch status when [ENTER] is pressed. If the **Increment** and **Decrement** functions have been linked to function keys, the signal linked to the object with these function keys will be set to one or reset.

### Operate Analog Objects

#### The ASCII Object

Move the cursor to the object and press [ENTER]. Enter the required text and finish with [ENTER].

#### The Message Object

Place the cursor on the object and press [ENTER]. A list of options will now be shown with all maneuverable statuses. Stepping to the required status and pressing [ENTER] will set the analog signal linked to the object to this status.

### **The Multiple Choice Object**

Place the cursor on the object and press [ENTER]. A list of options will now be shown with all maneuverable statuses. Stepping to the required status and pressing [ENTER] will set the analog signal linked to the object to this status.

### **The Analog Numeric Object**

Enter the value and press [ENTER] to maneuver numeric objects. If the value entered is too high or too low, the indicated maximum or minimum values for the object will be shown. This information is also shown if pressing [ENTER] when the object is maneuverable.

### **The Analog Numerical Table Object**

Pressing [ENTER] when the table object is selected will select the first cell in the table. Use the arrow keys to move the cursor between cells. Change the value for the marked cell and press [ENTER].

### **The Slide Object**

The object is maneuvered with the arrow keys by placing the cursor on the object and pressing [ENTER]. The value can now be increased or decreased with the arrow keys. Finish with [ENTER]. The value is increased/decreased with the number corresponding to the Scale ticks in the object. Finish with [ENTER].

The object can also be maneuvered with the functions **Increment** and **Decrement**, on the assumption that they are linked to the function keys, see the chapter [Function Keys](#).

### **The Bar Graph Object**

The min/max indicators for bar graphs can be set to the current value (reset) by pressing [ENTER] when the cursor is placed on the object.

For operator panels with touch screens the min/max indicators are reset when pointing at the bar graph.

## The Trend Object

Trend curves can show historical data when the operator panel is running. Not available for E1022. Mark the appropriate trend object and press [ENTER]. A dialog box will now be shown, where the time interval and date for the data to be presented can be selected. At the bottom of the box, "History" is shown. To return to real-time display, press [ENTER] again. Trend data is stored in files, the names of which are indicated when the trend objects are defined.

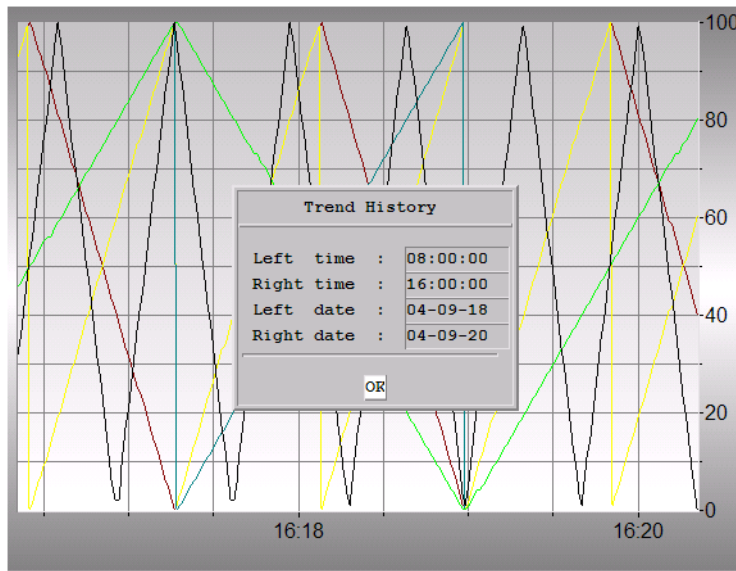

## Other Objects

### The Digital Clock

The digital clock (real-time clock) is changed by marking the object and typing the correct time. Finish with [ENTER].

### The Jump Object

Mark the object and press [ENTER].

## 4.4 Maneuvering Objects Using the Touch Screen

Operator panels with touch screens do not have a built-in keyboard. All maneuvering is done with the touch screen by pressing distinctly with a finger for more than 30 ms. Because of the screen's sensitivity you should only press one point on the display at once. If you press two points at the same time the display will interpret this as a point midway between the two points.

---

**Note:**

Pressing an object that is not maneuverable displays the text *Not maneuverable*. Pressing an object that is password-protected displays the text *Access denied*.

---

### Digital Objects

Digital objects; text, symbol and filled objects, switch status when pressing them with a finger.

### Analog Objects

#### The ASCII Object

Press on the object to display an alphanumeric keyboard on the display. Enter a text by using this keyboard, and finish with [ENTER].

#### The Multiple Choice Object

Press on the object to display a list of options. Select an object by touching it.

#### The Analog Numeric Object

Press on the object to display a numeric keyboard. Enter a value by using this keyboard, and finish with [ENTER].

#### The Analog Numerical Table Object

Press on a cell in the table object to display a numeric keyboard. Enter a value by using this keyboard, and finish with [ENTER].

#### The Slider Object

The object is maneuvered by pressing on the button in the object and dragging it.

#### The Bar Graph Object

The min./max. indicators can be reset by pressing on the bar graph.

## The Trend Object

Trend curves can show historical data when the operator panel is running. A row of buttons is shown under the trend when pressing the object.

Zoom button	Description
<<	Rewind one time range
<	Rewind 1/4 of a time range
-	Zoom in
^	Return to the first displayed trend history picture
+	Zoom out
>	Forward 1/4 of a time range
>>	Forward one time range

Return to real-time display by pressing the object again.

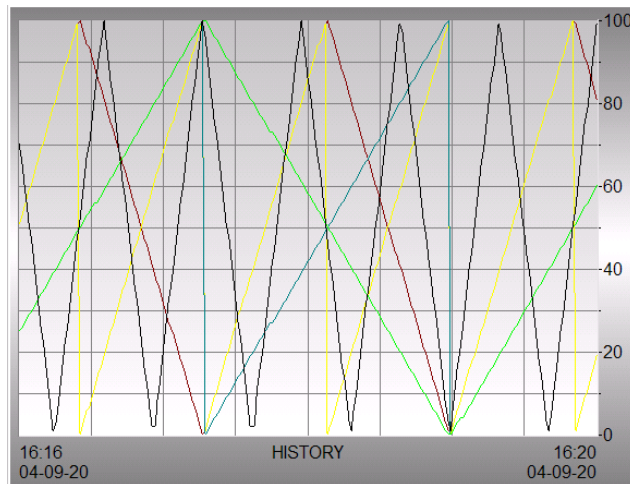

## Other Objects

### The Digital Clock Object

A numeric keyboard is shown when pressing the object. Enter the time by using this keyboard, and finish with [ENTER].

### The Jump Object

Touch the object to perform the jump.

## The Alphanumeric Keyboard

The alphanumeric keyboard is shown when an ASCII object is maneuvered, for example.



*The alphanumeric keyboard.*

Key	Description
A-Z	Used to enter required text.
À, Ä, Ö + blank	Extra keys that can be configured as different national characters. See section <a href="#">Properties for the Application Language</a> for further information.
Esc	Closes down the keyboard and returns to previous level.
←	Deletes a character to the left.
Clr	Deletes all written characters.
@	Used to enter the @ character.
✉	Opens a list with e-mail addresses.
Del	Deletes the character the cursor is placed on.
↵	Confirms the properties made and closes the keyboard.
→	Moves the cursor to the right.
←	Moves the cursor to the left.
a-z	Alternates between upper and lower case letters.
0-9	Alternates between letters, numbers and special characters.
SPC	Opens a selectable list of special characters.

A numeric keyboard is displayed when a numeric object is maneuvered, for example.



## 5 Text-based Presentation for Printouts and Reports

Text blocks are only used for printouts and reports, and cannot be displayed in the E1000-series operator panels, with exception for E1012, E1022 and E1032 that can display text blocks. Text-based presentation is used to create different types of report printouts and e-mail. These can be daily reports or status reports etc. Reports are built up of text blocks, which can contain both static and dynamic text. For examples of what a report can look like, please see the chapter [Printouts from the Operator Panel](#). This chapter presents text objects in table form. Every object is then described separately.

### 5.1 General Parameters

The **Properties** dialog for the selected object is displayed by double-clicking on the object on the working area.

The properties vary for the different objects and are described for each object.

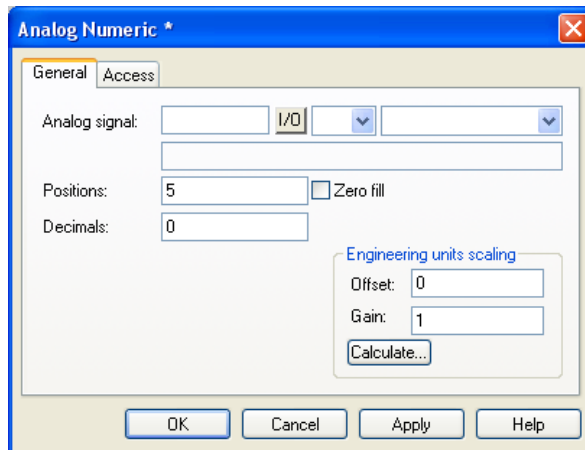

## Scaling

The scaling function is available for several text objects.

The parameters **Offset** and **Gain** are used to change the scale of the controller value to a value shown in accordance with the following equation.

$$\text{Panel value} = \text{Offset} + \text{Gain} * \text{Register value}$$

When the value for an object is changed from the operator panel, the scale is changed to the value shown in accordance with the following equation.

$$\text{RegisterValue} = (\text{PanelValue} - \text{Offset}) / \text{Gain}$$

Scaling does not affect the defined maximum and minimum values, or the number of decimal places.

### Offset Gain Calculation

The function **Offset Gain** calculation is a tool to calculate the offset and gain parameters. Specify the value of **Offset** and **Gain** under the **General** tab for the object and click on **Calculation**. The following dialog is now shown.

Input		
	Lower	Upper
Controller value range:	-32768	32767
Panel value range:	-32768	32767







  

Output	
Calculated offset:	0
Calculated gain:	1

Enter the range for the controller value and panel value. The correct values for the parameters **Offset** and **Gain** are calculated.

## 5.2 Text Objects

### Dynamic Text Objects

Symbol	Object	Description
	<i>Digital Text</i>	Switches between two texts depending on the status of a digital signal.
	<i>Multiple Choice</i>	Links to a data register, which can assume eight different states. A text of up to 30 characters can be linked to each state.
	<i>Analog Numeric</i>	Input and presentation of values in numeric form.
	<i>Bar Graph</i>	Presents values in the form of a bar graph.
	<i>ASCII</i>	Handles ASCII strings.
	<i>Date and Time</i>	Setting of date and time.
	<i>Message</i>	Shows texts from a message library.

## Digital Text

The **Digital Text** object is used to switch between two texts, of a maximum of 30 characters, depending on the status of a digital signal.

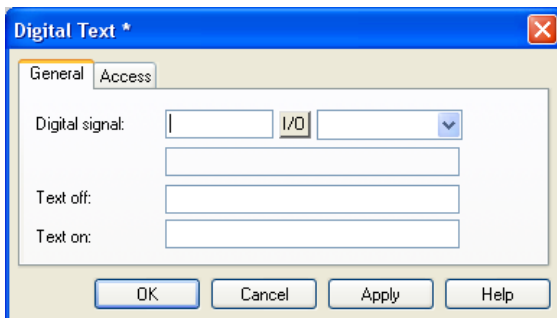

### General

Parameter	Description
Digital signal	The address of the digital signal.
Text off	The text to be shown when the signal is 0.
Text on	The text to be shown when the signal is 1.



## Multiple Choice

The **Multiple Choice** object can show one of up to eight different texts, depending on the value in a data register. The texts can contain a maximum of 30 characters.

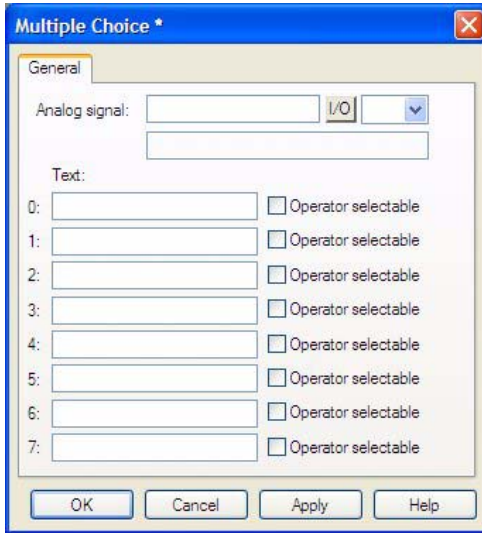

Parameter	Description
Analog signal	The data register which determines which text is to be shown. If the register contains the value 1, text 1 will be shown etc.
Text 0-7	Type a text to show for each register value. Selecting <b>Operator selectable</b> makes the object maneuverable for the operator.
Operator selectable 0-7	When checked, the operator can select this text when the operator panel is running.

## 03 Analog Numeric

The **Analog Numeric** object is used to create an input field and present values in numeric form.

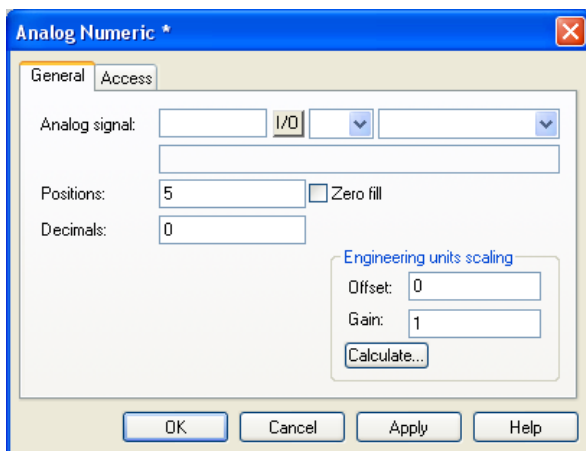

### General

Parameter	Description
Analog signal	The address of the signal.
Positions	The number of positions the entered value should be given, including comma and minus characters.
Zero fill	Select whether zeros are to be written in empty positions.
Decimals	The number of decimals the object is to be presented with.
Engineering units scaling	Used to scale register value. See the section <a href="#">General Parameters</a> .

## Bar Graph

The **Bar Graph** object presents whole or decimal numbers in the form of a bar graph. The bar will be shown horizontally so that the maximum number of positions are marked when the value has assumed its maximum level.

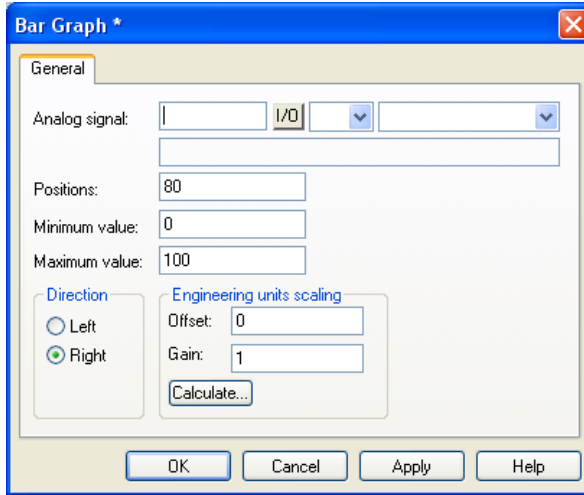

Parameter	Description
Analog signal	The address of the signal.
Positions	The number of positions the signal uses.
Minimum value	The minimum value for the object.
Maximum value	The maximum value for the object.
Direction	Select whether the bar is to be presented to the right or left.
Engineering units scaling	Used to scale the register value. See the section <a href="#">General Parameters</a> .

## ASCII

The ASCII object handles ASCII strings. It is possible to present texts stored in the controller's data register. The texts should be in IBM extended ASCII format. The texts can be changed from the operator panel by opening and closing the input field with [ENTER].

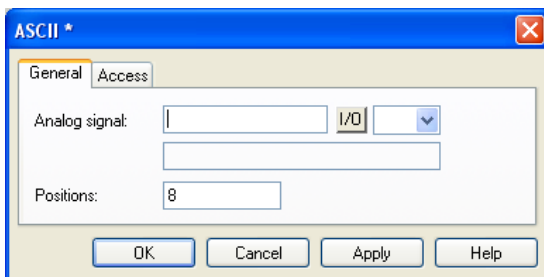

Parameter	Description
Analog signal	The register where the text for the first position is stored.
Positions	Each register contains two characters (assumes two positions). The default setting is 8 positions, which corresponds to four registers.



## Date and Time

The **Date and Time** object can be used to present a digital clock, day of the week and date. The Date and time object collects data from the real-time clock in the operator panel or the controller.

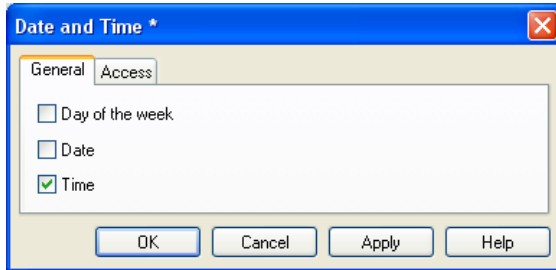

Parameter	Description
Day of the week	Select whether the day of the week is to be shown. Requires two positions.
Date	Select whether the date is to be shown. Use the format set under <b>Date/Time Format</b> in the <b>Setup</b> menu.
Time	Select whether the time is to be shown. Use the format set under <b>Date/Time Format</b> in the <b>Setup</b> menu.

## Message

The **Message** object presents texts from message libraries.

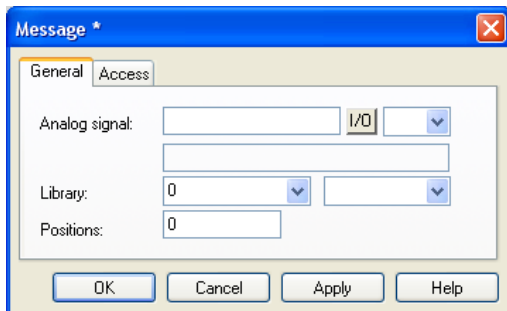

Parameter	Description
Analog signal	Analog signal that controls which text selected from message libraries is to be shown.
Library	The number or name of the required message library. Defined under <b>Functions/Message Library</b> .
Positions	The number of positions the text is to be presented with. 0 = automatic adjusting.

**Note:**

The number of positions should not be 0 when the function Library index register is used. See the section [Library index register](#).

For further information, see the chapter [Message Library](#).

## 6 Trends

This chapter describes the functions trends, real-time trends and historical trends. Trends are used to store data from the controller. There is no limitation regarding the number of trends in a project, it is only limited by the total operator panel memory. Trend data is stored in files, the name of which are indicated when the trend objects are defined.

For E1022 only real time trend is available. E1012 does not support the trend object at all.

### Presentation in the Operator Panel

Trend curves can show historical data when the operator panel is running. For key panels, mark the appropriate trend object and press [ENTER]. A dialog box will now be shown, where the time interval and date for the data to be presented can be selected. At the bottom of the box, "History" is shown. To return to real-time display, press [ENTER] again.

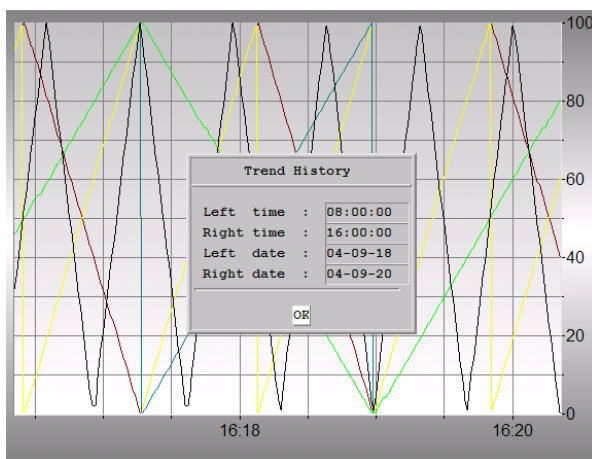

For touch panels, zoom buttons are used to zoom in the trend.

Zoom button	Description
<<	Rewind one time range
<	Rewind 1/4 of a time range
-	Zoom in
^	Return to the first displayed trend history picture
+	Zoom out
>	Forward 1/4 of a time range
>>	Forward one time range

## 6.1 Historical Trend

These functions mean that analog values from the controller can be collected and presented in a trend object in the operator panel. The presentation is in curve form. The collected values are stored in the operator panel's project memory.

It is possible to define several independent trend curves in the same or different blocks. The number is limited by the size of the project memory and its degree of utilization.

---

**Note:**

A large number of trend pens and a very frequent sample interval will affect the performance of the operator panel.

---

The time interval between the collection of data and how many values are to be stored are defined in the trend object.

### Calculation of Trend Size

It is possible to calculate how much space trend data will take up in the project memory with the following equation.

$$S = TOS + AK(2 + (AS + 1) * 8)$$

TOS = TrendObjectSize; if all parameters for a trend object are changed, TOS = 320 bytes.

AK = Number of defined curves in the trend object.

AS = Number of Samples rounded-off to the nearest hundred.

S = Number of bytes.

## 6.2 Defining Trend Objects

Trend objects are defined as other dynamic objects in a block. The object can be linked to up to six analog signals. As opposed to other objects, the trend object must be named with a name of 1-8 characters. The first character must be a letter or a number. Trend names may contain the characters A-Z, 0-9 and . Otherwise, the standard for file names in MS-DOS is followed. The following parameters are defined for trend objects. Double-clicking **Setup of terminal options** in the **Setup** folder in the Project Manager allows selecting whether trends are to be stored when changed, or if all samples are to be stored. For further information, see the section *Terminal Options*.

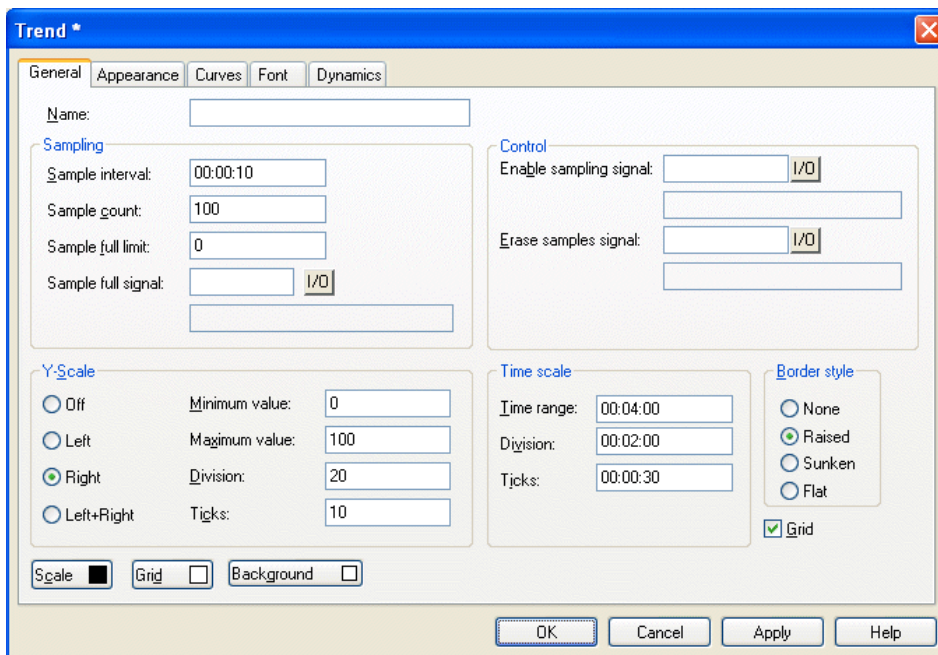

### General

Parameter	Description
Name	The name of the trend object (mandatory parameter). The name must be unique for each object, with a maximum of 8 characters. Only the characters A-Z, 0-9 and <u>.</u>
Sample interval	The interval in time between the collection of data. The minimum value is 1 second.

Parameter	Description
Sample count*	The number of values to be stored. The maximum number of values is 65,534.
Sample full limit*	The number of samples when <b>Sample full signal</b> is to be set to 1.
Sample full signal*	A digital signal which is set to 1 when the number of samples indicated under <b>Sample full limit</b> is reached.
Enable sampling signal*	A digital signal which, when it is set to 1, starts collecting data. If the signal is reset, the collecting stops. The parameter is optional.
Erase samples signal*	A digital signal which, when it is set to 1, deletes all historical trend data.
Y-scale	Select whether the Y-scale is to be invisible, seen to the left, the right, or both.
Minimum value	The minimum value that is displayed in the trend object.
Maximum value	The maximum value that is displayed in the trend object.
Division	How the scale on the Y-axis is to be divided.
Ticks	The interval between scale ticks.
Time scale	The time scale to be shown in the trend diagram.
Division	How the scale on the X-axis is to be divided.
Ticks	The interval between scale ticks.
Border style	Select whether a frame is to be drawn around the object.
Grid	Select whether a grid is to be shown in the object.
Scale*	The color of the scale.
Grid*	The color of the grid.
Background*	The background color of the trend object.

\* Not available for E1022.

## Curves

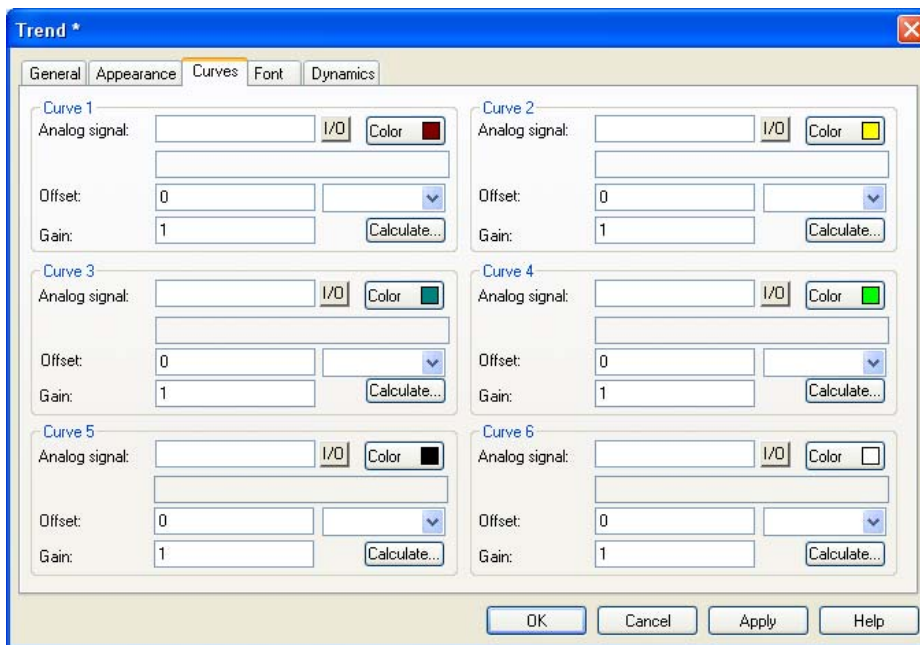

Parameter	Description
Analog signal	The analog signals which the object is to collect and present the values of.
Color	The color of each curve. For E1022 and E1032 a dashed or a solid line can be selected.
Offset and Gain	Used to scale the register value. See the section <a href="#">General Parameters</a> .

For E1022 only 2 curves are available.

### Other Tabs

The functions under **Appearance**, **Font**, **Access** and **Dynamics** are described in the section [General Parameters](#).

---

#### Note:

If a block containing a trend object is copied, the name of the trend object must be changed. Two trend objects cannot have the same name.

---

## Trend Settings

Select **Setup/Terminal Options** to make the general settings for all trends. The trend settings are not available for E1022.

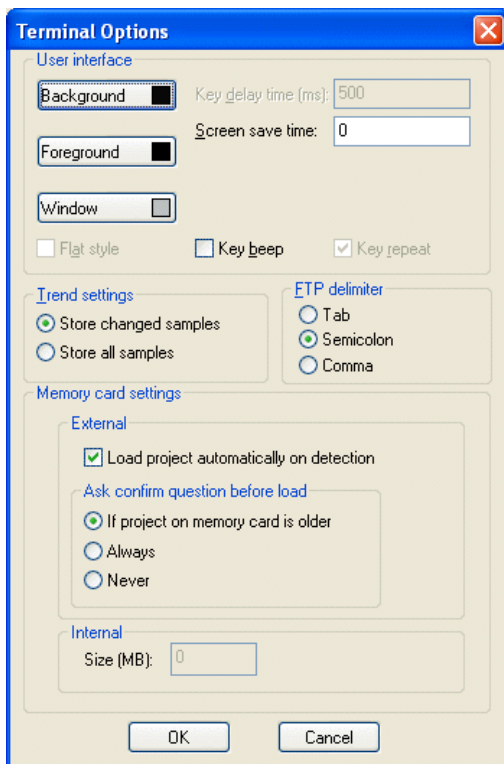

### Store changed samples

Select to only store samples in trends if the value has been changed since the last sample.

### Store all samples

Select to store all samples in trends even if the value has not been changed since the last sample. The parameters are valid in general for all defined trends.



## 6.3 Transfer of Trend Data

With the program HMI Tools File Transfer (icon in the program group HMI Tools) installed on the PC, it is possible for trend data, recipes and alarm lists to be transferred to/from the PC for statistical calculations and other types of presentation and storage. Not available for E1022.

It is also possible via FTP to transfer trend data, recipes, alarm lists, html files, operator panel applets and bitmap images between an operator panel and a PC. An FTP client program must be installed in the PC. In the program group HMI Tools there is a program, FTP Client, which functions as a standard FTP client.

Trend files can be opened directly in Excel for statistical calculations. See separate manual for HMI Tools.

### Trend Files

The names of trend files are specified for each trend when the trend object is defined. Files will be allocated the extension .skv. The format for each line in the trend file is the following: DDDD;TTTT;AAAA;BBBB;CCCC;DDDD;EEEE;FFFF:

Format	Description
DDDD	Date format specified in Setup.
TTTT	Time format specified in Setup.
AAAA	Trend curve 1.
BBBB	Trend curve 2 (if defined).
CCCC	Trend curve 3 (if defined).
DDDD	Trend curve 4 (if defined).
EEEE	Trend curve 5 (if defined).
FFFF	Trend curve 6 (if defined).

The oldest value is shown on the first line in the file, and the most recent on the last line. The format .skv can be imported directly to Microsoft Excel. In Excel, the diagram manager can be used to create statistical diagrams. It is not possible to make changes in the file and then send it back to the operator panel. The following diagram shows an example of how a trend can appear in Excel.

Device	Value					
04-01-07	10:18:10	0	0	0	0	0
04-01-07	10:18:40	103	0	0	0	25
04-01-07	10:18:51	26	53	0	0	25
04-01-07	10:18:55	26	53	0	137	25
04-01-07	10:35:00	26	53	0	137	25
04-01-07	10:35:26	0	0	0	0	0
04-01-07	10:35:35	90	0	0	0	0
04-01-07	10:35:44	86	0	0	0	0
04-01-07	10:35:51	87	0	0	0	0
04-01-07	10:36:20	87	0	0	0	0
04-01-07	10:36:48	0	0	0	0	0
04-01-07	10:36:57	90	0	0	0	0
04-01-07	10:37:01	87	0	0	0	20
04-01-07	10:37:04	89	120	0	0	20
04-01-07	10:37:06	89	120	0	38	20
04-01-07	10:38:00	89	120	0	38	20
04-01-07	10:38:25	0	120	0	38	20
04-01-07	10:38:36	189	120	0	38	20
04-01-07	10:38:40	60	120	12	38	20
04-01-07	10:38:55	60	120	12	38	14
04-01-07	10:38:58	61	47	12	38	14
04-01-07	10:39:03	104	47	12	65	14
04-01-07	10:39:07	60	47	47	65	14
04-01-07	10:39:57	62	47	12	65	14
04-01-07	10:40:00	60	47	12	65	46
04-01-07	10:40:04	61	18	12	65	46
04-01-07	10:40:06	60	18	12	99	46
04-01-07	10:40:12	62	18	12	456	46
04-01-07	10:40:15	61	18	12	456	478
04-01-07	10:40:17	60	145	12	456	478
04-01-07	10:40:21	61	145	152	456	478
END						

## 6.4 Backup of Trend Data

It is possible to copy trend data files from the ordinary project memory in the operator panel to an external memory card placed in the operator panel. Not available for E1022. The memory card in the operator panel must be formatted as a backup card. It can then be accessed in the operator panel via FTP, or brought to an arbitrary operator panel, to upload trend data via FTP transfer from the memory card to a PC for further processing. Trend files which have been backed-up can be found in the catalog (library) “backup” in the operator panel’s catalog structure. To read/write trend data files from/to the operator panel to the PC, there must be a FTP client program installed on the PC e.g. HMI Tools FTP Client program.

Backup of trend files from the operator panel’s project memory to the external memory card placed in the operator panel is done with the help of the command TBUP and a memory cell entered on the command line in the configuration tool. Double-click on **System Signals** under the **Setup** folder in the Project Manager.

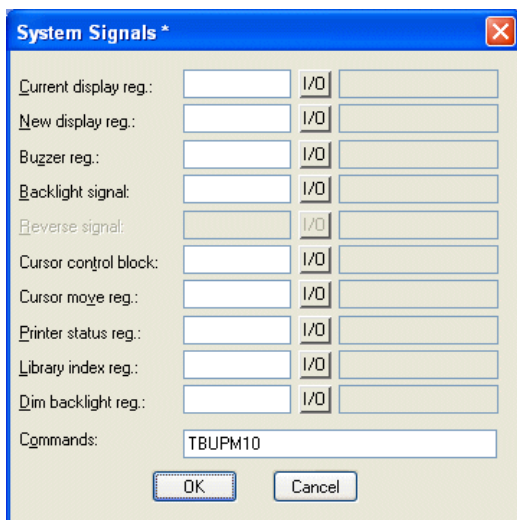

TBUP	Trend Backup. Used for backup copy of trend files on external memory card.
TESOSn	Storage of one trend sample only when the signal Activate is set to 1. If n=*, all trend objects are affected. If n=T, only trend objects that begin with T are affected.
TBS	The command is to be followed by one character that indicates which trends or data loggers that are to be copied to the external memory card. Only trends and data loggers that begin with this character will be copied when the TBUP signal is set.

TMBx	Trend Multi Backup. Used together with the system command TBUP to create more backup libraries on the backup card (x is the number of libraries with backup files on the card. When the defined number is exceeded, the oldest library is replaced. Default value is 1).
------	--

Enter the command **TBUP** followed by a digital signal e.g. **M10**. The digital signal can now be connected to a function or touch key. When the digital signal is activated from the key, all trend files (unless the TBS command is also used) from the operator panel's project memory will be backed-up on the external memory card. During the backup, trend sampling is disabled. When the backup is finished, the operator panel will reset the digital signal specified on the commands line.

There is also an error indication linked to the TBUP command, to the digital signal that follows the TBUP signal (TBUPx + 1). This bit will be set if something goes wrong during backup; for example if no memory card is inserted or if the memory card is write protected.

---

**Note:**

On an external memory card, only one version of a trend can be stored in each library. If a trend which already exists on the memory card is backed up, the trend will be deleted and replaced by the new trend. Create more libraries with the command TMBx.

---

## 7 Message Library

With the message library function, text tables can be created, where values between 0 and 65,535 are linked to texts. The message library function can be used for presentation of each sequence step in sequence control. Another possible application is to present error codes. An analog signal generates error codes connected to texts in a text library. This function can also be used to give analog values specific values, depending on the selected texts.

The message library is one of several text tables, each containing up to 512 text strings. Each text string can be 40 characters long. The function is activated by double-clicking **Message Library** in the Project Manager.

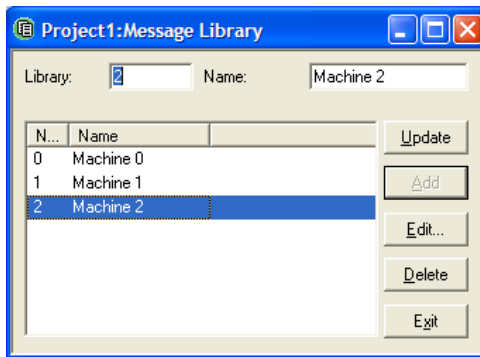

Parameter	Description
Library	Specify a number for the message library.
Name	Specify a name for the message library.

A message library is edited by selecting a library and clicking **Edit**. Several editing windows can be displayed at the same time.

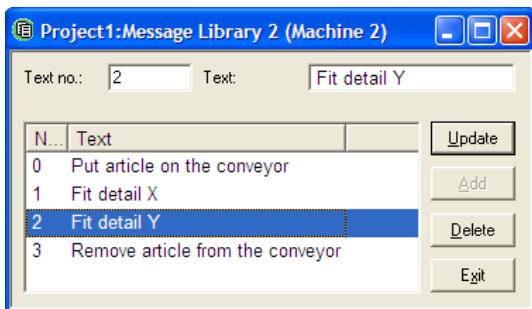

Parameter	Description
Text no.	Specify a number for the text, 0 - 65,535.
Text	The text presented when the current signal assumes the text number for the text.

## Example

The following example, with a sequence control where each step in the sequence is to be presented by a text, illustrates how the message library function can be used.

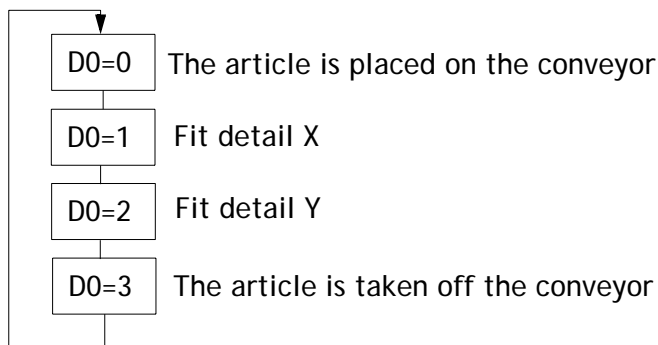

Start by creating a message library called Machine 2.

1. Double-click on **Message Library** in the Project Manager.
2. Specify a number for the library, in this case 2; and a name for the library, in this case **Machine 2**.
3. Click on **Add**.

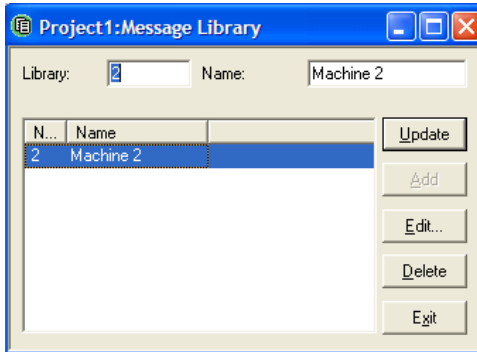

A message library called Machine 2 is now created. The next step is to define the different texts in the library.

4. Select the library and click **Edit**.

In this dialog, the parameters **Text number** and **Text** are defined. **Text number** is the value of the analog signal linked to the message object, and **Text** is the text shown in the message object.

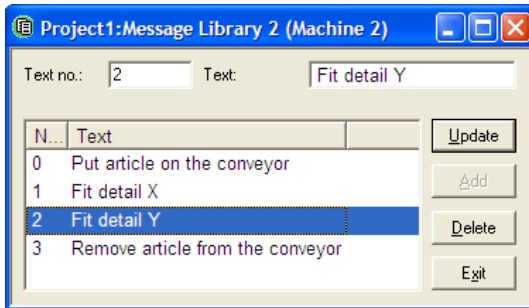

After finishing the configuration of the message library, a message object in the application is to be created. The message object can be created in both text blocks and graphic blocks.

5. Select the **Message** object from the Objects Toolbar, and click on the working area.
6. Specify the analog signal that is to control which text is to be displayed.
7. In the field **Library**, select the message library from which the texts are to be collected.
8. Select whether the object is to be maneuverable, and between which texts it can be switched during maneuvering, under the **Access** tab.

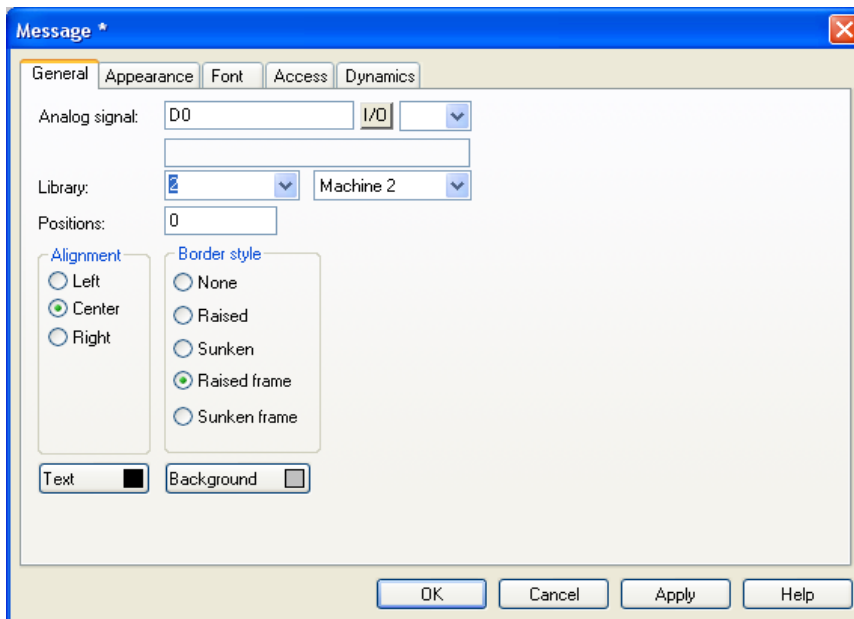



## 8 Alarm Management

This chapter describes the alarm management, a function that is used to call the operator's attention to events in the process requiring immediate action. Alarms can be divided into groups to create an order of priority, alarm texts can display texts and dynamic data in the alarm list, and the object Alarm Banner can call the attention to an alarm in any block in the application.

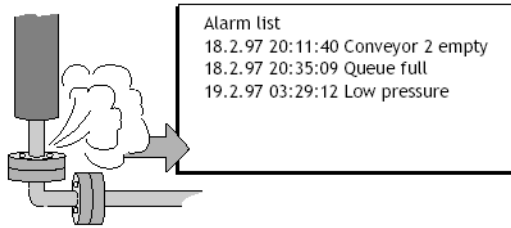

## 8.1 Alarm Groups

In the operator panel alarms can be divided into different groups, for example to indicate the priority of the alarms. Depending on the selected character size, up to 16 groups can be created. Each group can be allocated different color attributes. Alarms can be sorted in group order in the alarm block. It is not necessary to define alarm groups. For E1012 and E1022 only one group can be created.

### Defining Alarm Groups

Alarm groups can be defined under **Alarm groups** in the **Alarms** folder in the Project Manager. The attributes for the alarms in the group are determined in the following dialog box.

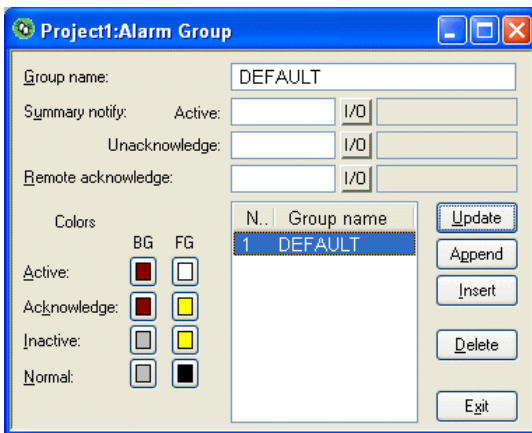

Parameter	Description
Group name	An optional name for the alarm group.
Summary notify	<b>Active</b> - Digital signal which is set to one when there are active alarms in the group. <b>Unacknowledge</b> - Digital signal which is set to one when there are unacknowledged alarms in the group. <b>Remote acknowledge</b> - Digital signal which when it is set to one acknowledges all alarms in the group simultaneously.
Colors	Indicates colors for active, acknowledged, inactive alarms, and for the normal status of the alarm. Not available for E1012, E1022 and E1032.

## 8.2 Alarms

Alarms are defined under **Alarms** in the **Alarms** folder in the **Project Manager**.

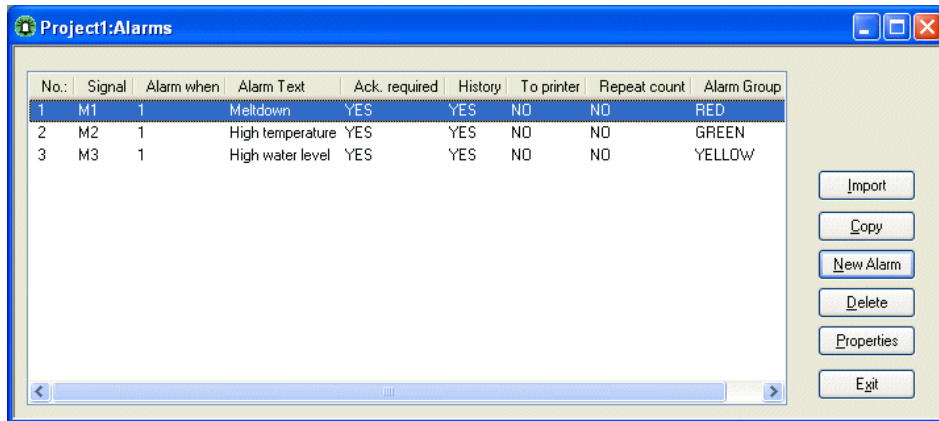

Button	Description
Import	See the section <a href="#">Alarm Import</a> .
Copy	Copy the alarm.
New Alarm	Define new alarm.
Delete	Delete alarm.
Properties	Shows the individual alarm's properties.

## Defining Alarms

A new alarm is defined by clicking **New Alarm** in the **Alarms dialog**. A maximum of 300 alarms is recommended.

Parameter	Description
Alarm text	An optional alarm text that will be shown in the alarms page. Maximum 78 characters in total. Can contain the objects: <b>Digital Text</b> Switches between two texts depending on the status of a digital signal. <b>Analog Numeric</b> Presentation of values in numeric form.
Signal	The signal (digital or analog) which when it assumes the specified status generates the alarm.

Parameter	Description
Alarm when	<p><b>Digital signal is: On/Off</b> - Select <b>On</b> if a signal set to one is to generate an alarm, and select <b>Off</b> if a reset signal is to generate an alarm.</p> <p><b>Analog signal is: Equal to</b> - An alarm is generated when the value of the given analog alarm signal is equal to the value specified in the subsequent field.</p> <p><b>Not equal to</b> - An alarm signal is generated when the given value of the analog alarm signal is not equal to the value specified in the subsequent field.</p> <p><b>Less than</b> - An alarm signal is generated when the given value of the analog alarm signal is less than the value specified in the subsequent field.</p> <p><b>Greater than</b> - An alarm signal is generated when the given value of the analog alarm signal is greater than the value specified in the subsequent field.</p>
Acknowledge notify	Digital signal activated when the alarm is acknowledged. The signal is normally set to one.
Reset	If the Reset box is checked, the above signal will be reset when the alarm is acknowledged.
Remote acknowledge	Digital signal which acknowledges the alarm when it is activated.
Alarm group	Indicates the alarm group for the definition (the alarm).
Info block	<p>A block number or block name for a text or graphic block can be stated here. This makes it possible to display a "help page" to the operator with, for example, information about the alarm and requisite procedures. If the field is left empty this means that no block is linked to the alarm.</p> <p>See the section <i>Alarms in the Operator Panel</i> and SMTP client.</p>
Mail to address	<p>Alarms can be sent as e-mail messages to pre-defined recipients. The alarm text will then be the subject of the message. Not available for E1012 and E1022.</p> <p>See the sections <i>Alarm Properties</i> and <i>SMTP Client</i>.</p>
Ack. required	Indicates whether the alarm is to be acknowledged or not. Checking the box means that the alarm must be acknowledged, leaving it unchecked means that the alarm functions as an event alarm, e.g. information.
History	<p>When the alarm is to be removed from the alarm list. Checking the box means that the alarm will remain in the list until the list is full. Leaving it unchecked means that the alarm will be removed from the list when it is acknowledged and no longer active. If the box <b>Ack. required</b> is not checked, the alarm will be removed from the list as soon as it is no longer active.</p>

Parameter	Description
To printer	Checking the box prints the alarm message directly on the printer if the alarm status changes.
Repeat count	If the box is checked, a counter for the alarm in the alarm list will be shown, that counts the number of times the alarm has been generated. The alarm must be acknowledged for it to be presented as a new alarm message in the alarm list.

---

**Note:**

The value defined for an analog alarm signal cannot be controlled from a register. An alarm is logged on a fixed value, logging on intervals is not supported. Only 16-bit values are supported.

---

## 8.3 Alarm Properties

Right-click on the **Alarms** folder in the Project Manager and select **Properties** to make general settings alarms and alarm lists. Alarms take up a different amount of space in the alarm list, depending on the length of the alarm text and the number of objects included. The space an alarm takes up can be calculated with the following formula:

$$S = 74 + NC$$

S = Number of bytes

NC = Number of characters in the alarm text

The alarm list is re-written when it is full. 25% is deleted, so that only 75% remains. Example: An alarm text of 38 characters, where each alarm takes up 80 bytes in the alarm list, resulting in 1024 (list size = 1 kbytes)/80 → Max. 12 alarms in the alarm list. When the 13th alarm is generated the alarm list will be re-written and only the last 9 alarms will remain in the list.

Parameter	Description
Active signal	The digital signal the operator panel sets to one when there is an active alarm.
Unacknowledged signal	The digital signal the operator panel sets to one when there is an unacknowledged alarm.
List erase signal	A digital signal which, when set to one, deletes non-active alarms in the list.

Parameter	Description
Reset	Checking the box resets the signal given in the List erase signal field when the alarm list is deleted.
List size	The list size in kB. Note that when the system allocates memory equal to that which is specified for List size, the actual size of the alarm list is twice the indicated size. The performance of the project is adversely affected if the list size is over 50 kB.
Enable alarm signal	A digital signal which, when set to one, activates alarm handling in the operator panel. This parameter makes it possible to switch on/off alarm handling in the operator panel. The parameter should not be used if alarm handling is to be active all the time.
Default font size	The default font size in the alarm list, that is always shown after restart or start-up, and after switching between operation modes.
Alarm symbol	When the alarm symbol is to be shown. In text blocks ■ALARM■ is shown, and in graphic blocks a bell is shown in the top right-hand corner of the display. No means that the alarm symbol is never shown. Unacknowledged means that the alarm symbol is shown when there are unacknowledged alarms in the alarm list. Active means that the alarm symbol is shown when there are active alarms in the alarm list. All means that the alarm symbol is shown when there are active and/or unacknowledged alarms in the alarm list.
Send e-mail	When alarms are to be sent as e-mail messages. Always means that an e-mail message is always sent when the status of the alarm changes. Active means that an e-mail message is sent when the alarm is activated. Inactive means that an e-mail message is sent when the alarm is inactivated. Acknowledge means that an e-mail message is sent when the alarm is acknowledged.
Backlight	If the background light is to be affected during an alarm. On means that the light is switched on when the alarm symbol is shown (default setting). Off means that the background light is not affected by alarms. Timer means that the light is switched on when a new alarm is activated, and switched off when the time for the screen saver has run out.
Alarm Cursor	The color of the cursor in the alarm list.
Repeat Count Time	Store first means that when the alarm is acknowledged the time for the first activated alarm will be stored in the alarm list. Store last means that when the alarm is acknowledged the time for the last activated alarm will be stored in the alarm list.



## 8.4 Alarm Import

It is possible to import alarm texts from name lists (generated from the configuration tool for the controller). The project in the configuration tool must be linked to a name list before alarm importing can be carried out. Select the relevant name list under **View/Name List**. Then double-click on the **Alarms** folder in the Project Manager, and click on the button **Import** to define the alarm import.

### Start I/O

State the address for the first I/O of the import from the name file. The start I/O can be an analog or a digital signal.

### End I/O

State the address for end of the import from the name file. The end I/O has to be of the same type as the start I/O.

### Alarm Properties

All alarms imported (start I/O to end I/O) when clicking on the button **Import** will have the same properties corresponding to the properties defined under **Alarm Properties**. For a description of the parameters, please see the section [Alarms](#).

The parameters, signal type, analog or digital and alarm group must be specified before an alarm import can be made.

## 8.5 Alarm Banner

The **Alarm Banner** object displays a line from the alarm list.

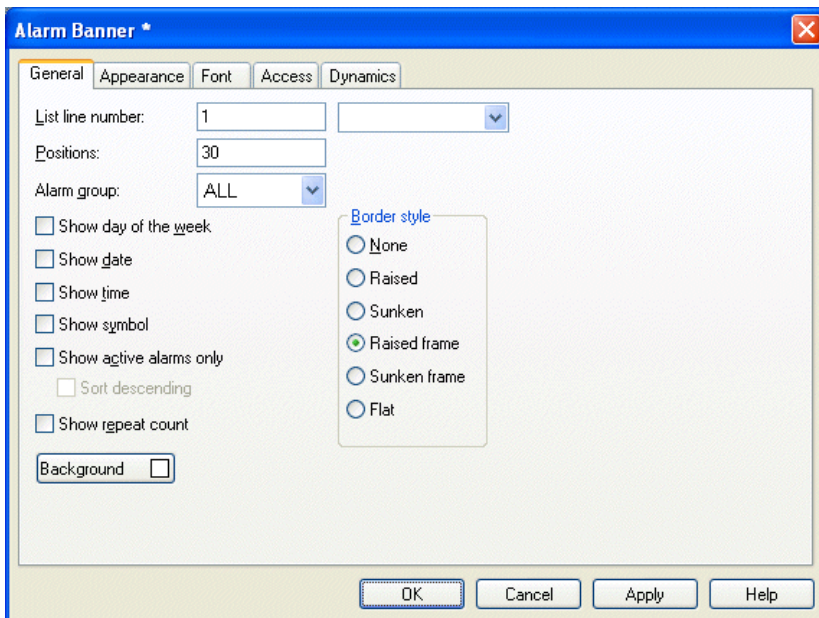

### General

Parameter	Description
List line number	The number of the line in the alarm list which the information is to be collected from (1 = first line, 2 = second line, etc.) if the indicated alarm group is shown in the alarm list.
Positions	The number of positions to be shown. Maximum total length (date, time and alarm text) is 101 characters.
Alarm group	Which alarm group to be shown in the alarm banner. The alarm banner will be shown in the color specified for the alarm group.
Show day of the week	Select whether the weekday is to be shown in the alarm banner.
Show date	Select whether the date is to be shown in the alarm banner.
Show time	Select whether the time is to be shown in the alarm banner.
Show symbol	Select whether alarm symbols are to be shown in the alarm banner.

Parameter	Description
Show active alarms only	Select whether only active alarms are to be shown on the alarm banner. If no alarm is active the alarm banner will be empty. The alarm must be inactive, not acknowledged, before the next alarm can be shown in the alarm banner.
Sort descending	Displays active alarms descending, i.e. the latest active alarm is displayed. Only available if <b>Show Active alarms only</b> is selected.
Show repeat count	How many times the alarm has been repeated.
Border style	Select whether a frame is to be drawn around the alarm banner.
Background*	The background color of the alarm banner.

\* Not available for E1012, E1022 and E1032.

---

**Note:**

An alarm can be acknowledged in the alarm banner by selecting the box **Enable acknowledge** under **Access**.

---

**Note:**

The foreground color of the alarm text is determined by the alarm group definition.

---

**Other Tabs**

The functions under **Appearance**, **Font**, **Access** and **Dynamics** are described in the section [General Parameters](#).

## 8.6 Alarms in the Operator Panel

In graphic blocks a bell flashes in the upper-right corner of the display when an alarm is activated. Indication can be deselected by right-clicking the **Alarms** folder and selecting **Properties** in the Project Manager.

Alarms are presented in an alarm list with predefined alarm texts. The alarm list contains the latest alarms and is arranged in alarm group order according to definition, so that the latest alarms are shown at the top of the list. Each alarm is presented on one row in the alarm list. To allow alarms using two rows in the list, the command **ALDR** can be used. Select **Setup/System Signals** and type **ALDR** on the **Commands** line.

The size of the alarm list is determined by right-clicking the **Alarms** folder and selecting **Properties** in the Project Manager. If there is a jump to an alarm block (system block no. 990), the alarm list will be shown.

The number of times the alarm has been generated (if selected), the status of the alarm, the time it was activated, became inactive or was acknowledged, is shown for every alarm, depending on the chosen display format.

Even if all of these parameters are not chosen for display in the alarm list, the information can be presented by configuring a function/touch key for this purpose. Select **Shows object info** under **Other functions** to configure the function key. Then select an alarm in the list. When the function key is pressed the first time, the time the alarm occurred is displayed. The following times the key is pressed, the time of acknowledgement and when the alarm became inactive is shown. See section [Function Keys](#) for further information about configuring function/touch keys.

The counter for the alarm in the alarm list is displayed according the following table, provided that the box **Repeat count** is checked for the alarm in the Alarms dialog.

Display format	Explanation
(12)	Means that the alarm has been generated 12 times. The alarm must be acknowledged for it to be presented as a new alarm message in the alarm list.
>999)	Means that the alarm has been generated more than 999 times without being acknowledged. The counter counts to a maximum of 999 alarms.

Alarms can assume the following statuses.

Symbol	Status
*	Active, Unacknowledged
\$	Inactive, Unacknowledged
-	Active, Acknowledged
<blank>	Inactive, Acknowledged

Alarm times can be shown in the following format.

Display format	Explanation
S	The time when the alarm was activated. The time the alarm was first activated is shown for repeated alarms.
E	The time when the alarm was inactivated. The time the alarm was last inactive is shown for repeated alarms.
A	The time when the alarm was acknowledged.

The alarm block can be accessed either by defining a jump to system block 990 in a block, by pressing [LIST], or by allowing the controller to present the list through a Display signal for block 990.

An alarm can be acknowledged by placing the cursor on the line with the alarm and clicking [ACK], by pointing at the alarm symbol or by acknowledging it with a function key. If a printer is connected, alarms can be printed out as they occur, or as their status changes. This is specified when the alarm is defined. Alarms will be printed with the number of events, date, time, status, and alarm text.

Historical inactive acknowledged alarms can be deleted by pressing [←] (BACK SPACE). This function can be disabled using the **DD** command. Select **Setup/System Signals** and type **DD** on the **Commands** line.

Return to the previous block by pressing [PREV] or pointing to [ESC] on the operator panel.

By selecting **Print signal** for block 990 it is possible to print the current content in the alarm list.

## Block Linked to Alarm

Text or graphic blocks can be linked to alarms. This means that when the operator presses the INFO button for an alarm in the list, the block linked to the alarm will be shown. This block can contain information about the alarm and suggestions for possible procedures. It is only possible to press the INFO key if the currently selected alarm is linked to a block. Return to the alarm list by pressing [PREV].

## 8.7 Alarm Backup

A backup copy of the alarms in the operator panel can be copied to an external USB memory stick, connected to the operator panel. One or more copies can be stored, depending on the configuration. All files are stored in the directory *\Backup\Alarms* on the USB memory stick.

### File Names

The file name of the alarm backup is in the format eight characters + three characters extension (standard MS-DOS file naming).

The file name contains [year][month][day][hour].[number]. Number starts at 0 each hour, and is incremented for each backup stored. The range of number is 000-999. 1000 backups can be stored each hour.

### Example

A backup created on the 12th of October 2007, 14.30:30 can be given the name *07101214.003*. The next stored backup is created on the 12th of October 2007, 14.50:30, and will be named *07101214.004*.

### File Format

The format is ASCII file with field separators. The separator, tab, semicolon (;) or comma (,), is selected in the user project.

## Executing the Backup Function

Alarm backup can be activated in two ways:

- Using a function/touch key  
Select the action **Saves alarm list to memory card** under **Other functions** when assigning actions to keys in the configuration tool. When the function/touch key is pressed, the alarms are backed up on the USB memory stick.
- Using a bit device declared with the **ABUPx** command  
The command **ABUPx** is stated on the **Commands** line under **Setup/System signals**, where **x** is a bit device. Two consecutive bit devices are used. The first device is a trigger, and the second device is an error bit.

### Example

Type **ABUPM10** on the **Commands** line to use the bit device M10 to trigger the backup function.

When the backup is finished, a 0 is written to the trigger device. In case of error, a 1 is written to the error device.

---

### Note:

If a driver using variables in its communication, a bit array or a variable type which can be enumerated, must be used. E.g. with **ALARMBACKUP.\$0**, then **ALARMBACKUP.\$1** is used as error device.

---

## Number of Stored Backup Files

By default, one backup file is stored. When storing a backup file any old file, if present, will be deleted. It is possible to store more than one file using the command **AMBn** on the **Commands** line, where **n** indicates the number of backup files that will be stored.

### Example

Type **AMB5** on the **Commands** line to store five backup files. When a sixth file is stored, the oldest existing file is deleted.

## 8.8 Graphic Alarm Page

This page is graphic and the pre-defined function keys or touch keys can be modified by the user. The alarm list area of the page cannot be modified by the user. Function keys or touch keys are linked to functions to enlarge or reduce the text on the alarm page, including page browsing functions. There is also a function to select whether the date and time stamps are to be shown. Alarms can be sorted by group, and the group shown is optional. Status is shown with different colors, i.e. the colors defined when setting the alarm groups.

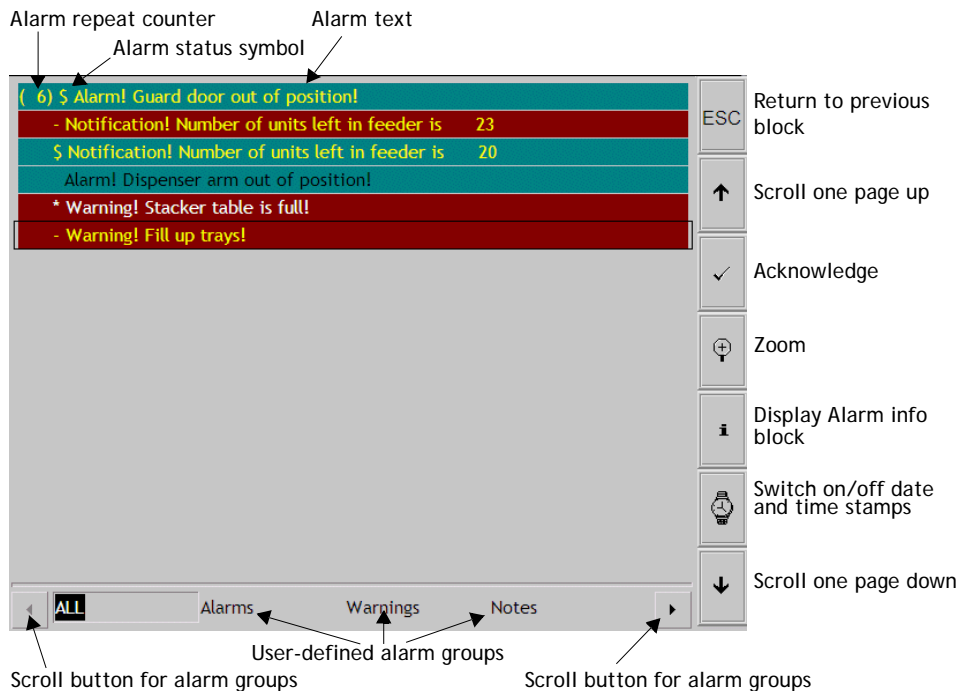

The command **ALOFx** can be used to indicate if any active alarms are deleted from the alarm list (alarm list overflow). Select **Setup/System Signals** and then type **ALOF** followed by a bit device (**x**) on the **Commands** line. If an active alarm is deleted, the bit will be set.

---

### Note:

The graphic alarm page (alarm list) is printed as a text printout.

---



## 9 Recipes

This chapter describes the function for recipe management, which enables all the dynamic data in one or more blocks, i.e. the signals and their values, to be saved to a file in the operator panel. The operator can then download the files to the controller, which will start working with the new values. By using the function for recipe handling it is possible to reuse large sets of parameters. The user can create recipe libraries consisting of files containing different sets of parameters. This function improves the efficiency of time-critical productions where the exchange of similar products must be done quickly, such as in the manufacturing of units in different colors. Recipe files can be created from the operator panel, the controller or from a PC with the program HMI Tools.

Recipe files are stored in the operator panel. To use recipe handling the functions for storing, loading, deleting and adding, recipes must be linked to function or touch keys. See the chapter *Function Keys* for information.

Recipe files can be sent as attachments with the e-mail function.

The drawing below illustrates the principle of the recipe handling function.

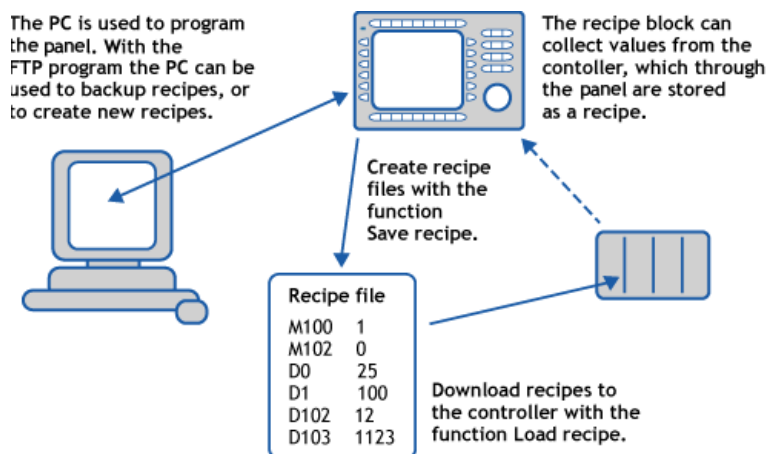

## 9.1 Calculation of Recipe Size

To calculate how much space a recipe requires in the project memory, the following equation is used. (The equation is not exact in view of the file system's complexity in the operator panel.)

$$S = 90 + \Sigma (2 * IOG_i + 28)$$

S = number of bytes. If S is calculated to be less than 360, then S is set to 360.

$\Sigma$  = number of I/O series.

$IOG_i$  = number of I/O in each I/O series

---

### Note:

The maximum number of I/Os in a recipe is 1000.

---

### Example

The recipe consists of 3 I/O series: D0-D109 (110), D200-D499 (300) and M0-M99 (100).

The calculation is made in two steps.

1. Calculate the subtotals of the different series:

$$1104 = (2 * 110 + 28) + (2 * 300 + 28) + (2 * 100 + 28)$$

2. Then calculate the total:

$$S = 90 + 1104$$

$$S = 1194 \text{ bytes}$$

## 9.2 Recipe Properties and Recipe Directory

Double-click on **Recipe** in the Project Manager to make properties for recipe handling and to create, edit and delete recipe directories.

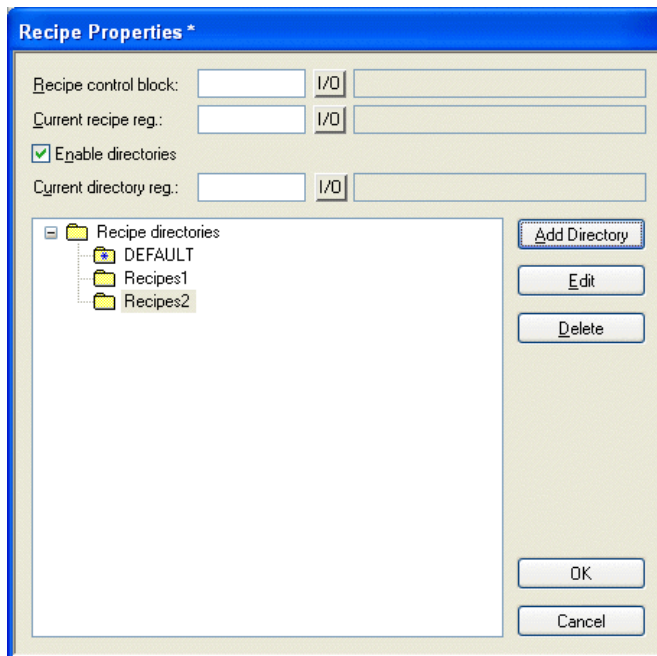

Parameter	Description
Recipe control block	Control block to save/read/delete recipes through the controller. See the section <a href="#">Creating and Transferring Recipes with the Controller Program</a> .
Current recipe reg.	The first of 4 or 16 16-bit registers where the operator panel inserts the name of the last loaded recipe to the controller. The name can then be presented in an ASCII object. The function uses either 4 registers (8 characters), see section <a href="#">When Using Recipe Names of up to 8 Characters</a> , or 16 registers (32 characters), see section <a href="#">When Using Recipe Names of up to 32 Characters</a> .
Enable directories	Checking the box allows creating recipe directories in the operator panel. See the section <a href="#">Recipe Directories</a> .
Current directory reg.	The first of 4 or 16 16-bit registers where the operator panel inserts the name of the recipe directory specified for the block. The name can then be presented in an ASCII object. The function uses either 4 registers (8 characters), see section <a href="#">When Using Recipe Names of up to 8 Characters</a> , or 16 registers (32 characters), see section <a href="#">When Using Recipe Names of up to 32 Characters</a> . See also section <a href="#">Recipe Directories</a> .

## Recipe Directories

Recipes created in the operator panel can be saved in different recipe directories (folders) in the operator panel's memory or on an external memory card if it is used in the operator panel. The use of recipe directories ensures a better structure and easier handling of recipes in applications with a large number of recipes. It is possible to create 32 different recipe directories in one level. Recipe directories are saved under the directory RECIPE in the root directory in the operator panel's memory. A recipe directory is linked to one or more blocks under block properties for the block. All recipes created in the block will then be saved in the selected recipe directory.

For information about saving individual recipes to and external memory card, either created from the operator panel or from the controller program, see section [Saving Individual Recipes on an External Memory Card in Runtime](#).

Recipe directories are created, edited and deleted by double-clicking on **Setup of recipe signals** in the Project Manager. Defined recipe directories are shown in a list, according to the structure in the directory. New recipe directories are added by clicking the button **Add Directory**. The name of recipe directories has to consist of 1-32 characters. The first character must be a letter or digit, and can only contain the characters A-Z, 0-9 and `_`. However, when using the MCRD# command, the character # may also be used.

See the section [Saving Individual Recipes on an External Memory Card in Runtime](#).

Change a recipe directory by selecting it and clicking **Edit**. Click **Delete** to delete the selected recipe directories.

### Recipe Directories in the Operator Panel

Recipe directories can be created and deleted with the functions **Make recipe directory** and **Delete recipe directory**, linked to function keys or touch keys, when the operator panel is running. With the function **Change recipe directory** for function keys or touch keys it is possible to change/select recipe directories for the current block. A list of options for available recipe directories is shown when the function key or touch key for **Change recipe directory** is pressed. Select one and press [ENTER]. The recipe in the block will now be saved in the selected recipe directory.

See the section [Function Keys](#) for further information.

---

#### Note:

Recipe directories created in the configuration tool cannot be deleted with a function key or touch key linked to the function **Delete recipe directory**.

---

Recipe handling between operator panel and PC is performed with the program HMI Tools File Transfer and HMI Tools FTP Client. See the section [Using Recipes in a PC](#) and the manual for HMI Tools.

## 9.3 Creating a Recipe with the Operator Panel

When the application is programmed, blocks can be used to save recipes, or alternatively the function **Append recipe** can be used when the operator panel is running. All signals to be included in the recipe are defined in the recipe block. All dynamic values in the block are stored in the recipe file. All digital and analog objects, with the exception of trend objects, can be used as recipe parameters.

When the operator panel is running, a jump is made to the block containing the recipe parameters. Enter the required values in the dynamic objects and press the function or touch key linked to **Save recipe**. When saving a recipe, the options **Replace existing** or **Save as new** are available. If **Replace existing** is selected all existing recipes are listed, and the user selects which recipe to replace. When selecting **Save as new**, the user enters the recipe name. The name has to consist of 1-32 characters. The first character must be a letter or digit, and can only contain the characters A-Z, 0-9 and **\_**. However, when using the MCRD# command, the character # may also be used. See section *Saving Individual Recipes on an External Memory Card in Runtime*.

Recipe files are stored in the operator panel, either in the recipe directory specified for the block, or in one and the same recipe directory if no separate recipe directories have been created by double-clicking on **Recipe** in the Project Manager.

### Limiting the Size of Recipe Names and Directories Written to the Controller

Some controller programs have been configured to allow only 8 characters to store the names of recipes and recipe directories in the controller. If accidentally using names of up to 32 characters, important information in the controller might be overwritten. To avoid this, the **SCRR** command (ShortCurrentRecipeRegister) can be used. Select **Setup/System Signals** and type **SCRR** on the **Commands** line.

When this command is used, a maximum of 8 characters can be entered for recipe names and directories in the operator panel.

---

**Note:**

It will still be possible to enter longer recipe directory names using E-Designer. If a longer name is saved in the controller, the name will be truncated and only the first 8 characters are stored.

---

## 9.4 Appending Recipes

The function **Append recipe** can be linked to function and touch keys and makes it possible to add signals and their values from the current block to an existing recipe in the operator panel. This entails that the operator can save signals and their values from several different blocks in a joint recipe. New signals are added to a recipe, and signals already existing in the recipe will be updated when the function is activated. The name of the recipe to which the current block's signals and their values are to be added is specified when the function or touch key for **Append recipe** is pressed. When appending a recipe, the options **Replace existing** or **Save as new** are available. If **Replace existing** is selected all existing recipes are listed, and the user selects which recipe to replace. When selecting **Save as new**, the user enters the recipe name. If the function is activated and there are no recipes saved in the operator panel, a new recipe will be created in the operator panel. Similarly, a new recipe will be created if the same recipe directory for the block is not given. To add signals from another block to a recipe the same, or no recipe directory, must therefore be given for both blocks.

---

**Note:**

If a string is added to an existing recipe with strings, the strings must be separated by address space. Otherwise the previous near string will be increased.

---

## 9.5 Transferring Recipes to the Controller

Recipes are transferred to the controller with the function **Load recipe** when the operator panel is running. This function means that the signals and their values stored in the file are transferred to the controller. A list of options for available recipe directories is shown when the function or touch key for **Load recipe** is pressed. Select one, and press [ENTER]. The controller will then run with the downloaded values.

## 9.6 Deleting Recipes

A selected recipe can be deleted from the operator panel memory with the function **Delete recipe**. Press the function or touch key linked to **Delete recipe**. A list of options will now be shown with the available recipe files. Select the file to be deleted, and press [ENTER]. Confirm with [ENTER] or press [PREV] to abort.

## 9.7 Using Recipes in a PC

The PC can be used to make backup copies of files in the operator panel, e.g. recipe files. New recipes can be created in the PC and transferred to the operator panel. Recipes saved in the operator panel can be transferred and edited in a PC.

Recipe files are stored in the PC in .skv format, and can be displayed and edited in Microsoft Excel. Edited files can then be used in the plant again. The files must end with the instruction END, according to the example below:

```
M100    ;1
M102    ;0
D0      ;25
D50     ;12
END
```

It is also possible to transfer recipe files between the operator panel and the PC through FTP with the program HMI Tools FTP Client (standard FTP client). For further information, refer to the manual for HMI Tools.

Files will be saved to a Compact Flash memory card or USB Flash drive by means of the function *saves recipe on memory card* via a function key/touch key. The recipes will be copied to the external memory card, from the operator panel's internal memory.

---

### Note:

Use of Compact Flash cards is not supported in the E1012, E1022, E1032, E1041, E1043, E1060, E1061, E1062 and E1063 operator panels.

---

For information about saving individual recipes to and external memory card, either created from the operator panel or from the controller program, see section [Saving Individual Recipes on an External Memory Card in Runtime](#).

When the operator panel is running, a selected recipe can be deleted from the operator panel memory with the function *Delete recipe*. Press the function or touch key linked to *Delete recipe*. A list of options will now be shown with the available recipe files. Select the file to be deleted, and press [ENTER]. Confirm with [ENTER] or press [PREV] to abort.

## 9.8 Creating and Transferring Recipes with the Controller Program

Through a control block in the controller recipes can be created, transferred and deleted in the operator panel. Files created from the controller program are compatible with recipe files created from the operator panel. This means that recipe files created in the controller program can be downloaded into the operator panel, and vice versa. The control block can appear as follows.

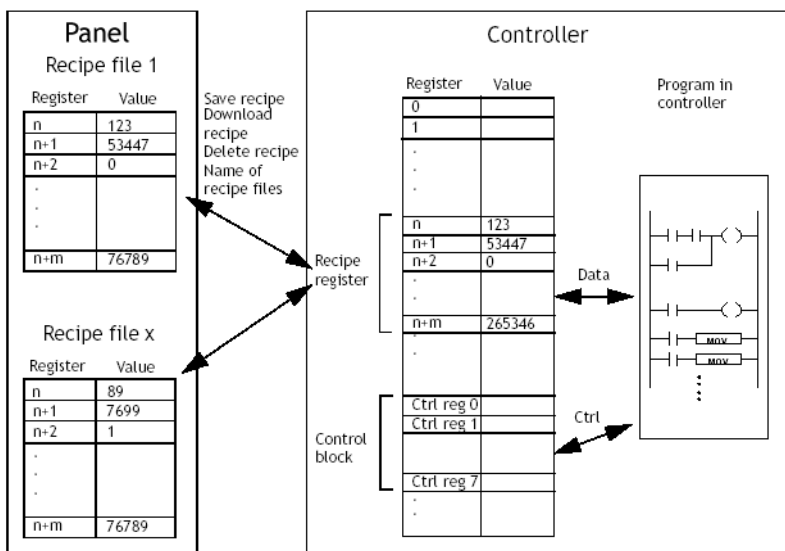



## When Using Recipe Names of up to 8 Characters

By double-clicking **Setup of recipe signals** in the Project Manager the first register in the control block is defined. This and the 7 following registers are used as control registers. The control block is described in the following table.

Register	Content	Description
Control register 0	Command	Command register set by the controller. Available commands: 0: No command. 1. Save recipe to operator panel. 2. Read recipe from operator panel. 3. Delete recipe from operator panel. 4. Create recipe directory. 5. Change recipe directory. 6. Delete recipe directory.
Control register 1	Handshake	Handshake register set by operator panel. 0. Ready for new command. 1. OK 2. Recipe file write error. 3. Recipe file not found.
Control register 2	File name characters 1-2	Name of recipe file/recipe directory in the operator panel.
Control register 3	File name characters 3-4	
Control register 4	File name characters 5-6	
Control register 5	File name characters 7-8	
Control register 6	Start data register	The first data register to be read/written to/from recipe file.
Control register 7	Number of registers	Number of registers to be read/written to/from recipe file.

## When Using Recipe Names of up to 32 Characters

Not available for E1012 and E1022. By double-clicking **Setup of recipe signals** in the Project Manager the first register in the control block is defined. This and the 19 following registers are used as control registers. 16 registers contain the name and 4 registers control load, save etc. according to the table below.

Register	Content	Description
Control register 0	Command	Command register set by the controller. Available commands: 10. No command. 11. Save recipe to operator panel. 12. Read recipe from operator panel. 13. Delete recipe from operator panel. 14. Create recipe directory. 15. Change recipe directory. 16. Delete recipe directory.
Control register 1	Handshake	Handshake register set by operator panel. 0. Ready for new command. 1. OK 2. Recipe file write error. 3. Recipe file not found.
Control register 2	File name characters 1-2	Name of recipe file/recipe directory in the operator panel.
Control register 3	File name characters 3-4	
Control register 4	File name characters 5-6	
Control register 5	File name characters 7-8	
Control register 6	File name characters 9-10	
Control register 7	File name characters 11-12	
Control register 8	File name characters 13-14	
Control register 9	File name characters 15-16	
Control register 10	File name characters 17-18	
Control register 11	File name characters 19-20	
Control register 12	File name characters 21-22	
Control register 13	File name characters 23-24	
Control register 14	File name characters 25-26	
Control register 15	File name characters 27-28	
Control register 16	File name characters 29-30	
Control register 17	File name characters 31-32	
Control register 18	Start data register	The first data register to be read/written to/from recipe file.
Control register 19	Number of registers	Number of registers to be read/written to/from recipe file.

The following procedure must be carried out:

1. The result code register must be 0. If not, reset the command register to 0 or 10.
2. Enter the command in the command register.
3. Wait for the ready signal or error code in the handshake register.
4. Set the command register to 0 or 10. The operator panel will now set the handshake register to 0.

### Limitations

Recipes created in the controller can contain a maximum of 1000 registers. Only data registers can be used.

Recipe names can only contain the characters A-Z, 0-9 and `_`. However, when using the `MCRD#` command, the character `#` may also be used.

See section *Saving Individual Recipes on an External Memory Card in Runtime*.

## 9.9 Saving Individual Recipes on an External Memory Card in Runtime

When saving recipes on an external memory card by means of the function **Saves recipe on memory card**, the entire recipes directory in the operator panel will be saved to the memory card.

In some situations it can be useful to only save some of the recipes to an external memory card. Then the **MCRD#** command has to be used. The procedure for saving individual recipes to an external memory card is described in the example below.

### Settings in E-Designer

1. Select **Setup/System Signals** and type **MCRD#** on the Commands line. Click **OK**.

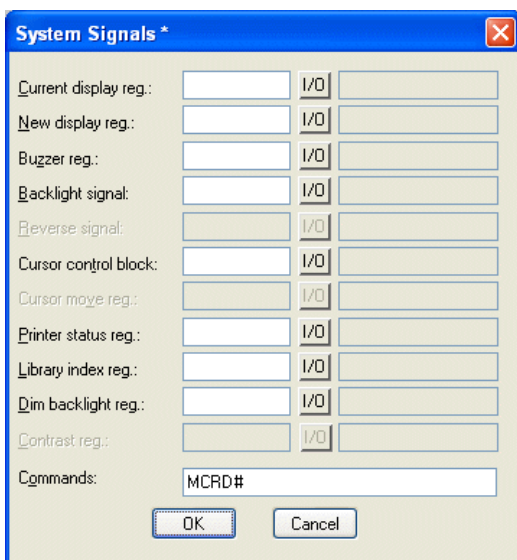

2. Select **Enable directories** in the Recipe Properties dialog. Click **OK**.

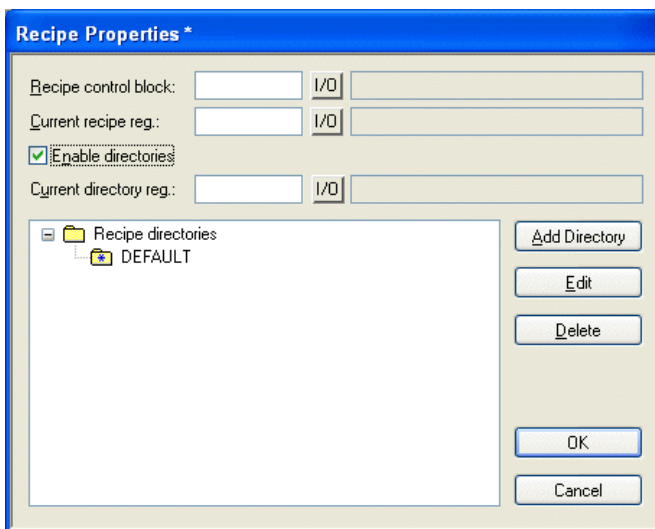

## Settings in the Operator Panel

3. Create a directory, for example named #RECIPES\_EXTERNAL, by using the **Create recipe directory** command. The # character must be entered in front of the directory name.
4. Use the **Change recipe directory** command to change to the new directory.
5. When pressing for example a touch key with the **Save recipe** function, the current recipes will be stored in the RECIPES\_EXTERNAL directory on the external memory card. When saving a recipe, the options **Replace existing** or **Save as new** are available. If **Replace existing** is selected all existing recipes are listed, and the user selects which recipe to replace. When selecting **Save as new**, the user enters the recipe name.

---

### Note:

Use of Compact Flash cards is not supported in the E1012, E1022, E1032, E1041, E1043, E1060, E1061, E1062 and E1063 operator panels.

---



## 10 Data Logger

Data can be logged and saved to file similar to trend (but without operator panel display). Not available for E1012, E1022 and M70. Logging of data can be made at different intervals or depending on changed values. 16 signals can be connected to each data logger. 16-bit, 32-bit and Real (Float) values can be logged. Be aware that logging of data consumes system resources and memory.

Double-click on **Data logging** in the Project Manager. Right-click on **Data logging** in the window that is displayed, and select **Add**. Double-click on **Data logger** to display the dialog below.

The following properties can be made:

Parameter	Description
Name	State a name for the data logger. The name, that has to be unique for each logger, can consist of a maximum of 8 characters. Only the characters A-Z, 0-9 and _ are supported.
Sample interval	State the interval for data logging. The minimum value is 1 second.
Sample count	State the number of values to be saved. The maximum value is 65,534.

Parameter	Description
Sample full limit	State by which number of samples <b>Sample full signal</b> is to be set, and which signal to set.
Sample full signal	
Store	Select <b>Changed</b> to store only values that are different from the last sampling. Select <b>All</b> to store all values.
Enable sampling signal	State a digital signal that, when set, starts logging data. The logging is stopped if the signal is reset. The parameter is optional.
Erase samples signal	State a digital signal that, when set, erases logged data. The parameter is optional.

For information about Data Logger backup and transfer, please see the respective section in chapter [Trends](#).



# 11 Passwords

This chapter describes the handling of security levels and passwords in the operator panel. It is a function which makes it possible to create a security system for the plant. The operators can easily be assigned different authorizations in the plant.

Blocks, function/touch keys and maneuverable objects can be allocated security levels. Each security level is associated to a password. To access the different levels the user must login with a password for the relevant security level, or higher. It is not necessary to use this function.

## 11.1 Defining Security Levels

Blocks, function/touch keys and maneuverable objects can, when they are defined, be allocated a security level. A security level (0-8) is specified in the dialog for the object under the **Maneuvering** tab after checking **Enable operator input**. If security level 0 is specified, the object will be available to everyone, i.e. login will not be requested.

## 11.2 Defining Passwords

Passwords for the security levels 1-8 are defined by double-clicking the **Password** folder in the Project Manager.

Security level:	Password	Confirm question	Comment
1:	<input type="text"/>	<input type="text"/>	<input type="text"/>
2:	<input type="text"/>	<input type="text"/>	<input type="text"/>
3:	<input type="text"/>	<input type="text"/>	<input type="text"/>
4:	<input type="text"/>	<input type="text"/>	<input type="text"/>
5:	<input type="text"/>	<input type="text"/>	<input type="text"/>
6:	<input type="text"/>	<input type="text"/>	<input type="text"/>
7:	<input type="text"/>	<input type="text"/>	<input type="text"/>
8:	<input type="text"/>	<input type="text"/>	<input type="text"/>

Login signal:  I/O   
 Logout signal:  I/O   
 Login level reg.:  I/O   
 Current level reg.:  I/O   
 Login timeout:  minutes  
 Password RUN/PROG:   Automatic login

Parameter	Description
Password 1-8	The password for security level 1-8.
Confirm question 1-8	An optional question, with a maximum of 20 characters, to be displayed when a password protected object is maneuvered by a logged-in user, e.g. "Change parameter?" The confirm question cannot be used if a function- or touch key has been defined with the security level.
Comment 1-8	Used to facilitate selecting a password level for the object using a name, e.g. Supervisor or Operator.
Login signal	A digital signal which, when it is set to one, generates a login dialog. The login dialog can also be linked to a function or touch key. See the chapter <a href="#">Function Keys</a> for further information.

Parameter	Description
Logout signal	A signal which, when it is set to one, logs out the current user. The function can also be linked to a function or touch key. See the chapter <i>Function Keys</i> for further information.
Login level reg.	A register in the controller to control the security level can be specified here. The value in the register determines the current security level, value 0 = no security level, 1 = security level 1, etc.
Current level reg.	Specify a register from where the operator panel can present the current security level (0-8).
Login timeout	Specify the time in minutes which the operator panel can remain inactive before the user is automatically logged out. If 0 is given there will be no logout.
Password RUN/ PROG	This function is not used for the E1000 operator panels.
Automatic login	Specify if the login window is to be automatically shown when trying to access password-protected blocks or keys. For touch screen operator panels, the function is also applicable for objects.

### 11.3 Logging in

If the box for automatic login in the Password dialog is not checked, the login will either be controlled from a function or touch key, or through a digital signal from the controller (**Login signal**). If the function key linked to the function **Login to specified security level** is pressed, or the digital signal is activated, the input field for login will be shown. Specify password. The password is linked to a security level, see above.

### 11.4 Password for Project Transfer

Commands can be entered on the command line by double-clicking on **System Signals** in the **Setup** folder in the Project Manager. By entering the command PDxxxxxxx, where xxxxxxxx represents the password, this password must be given to access the functions in the TRANSFER menu in the operator panel. When transferring projects from the configuration tool to the operator panel this password must be given in the operator panel. Only capital letters can be used on the command line.

## 11.5 Overriding Password

Commands can be entered on the command line by double-clicking on System Signals in the Setup folder in the Project Manager. By entering the command PSxxxxxxx, where xxxxxxxx represents the password, this password can be used to override all other password levels, and the user gains access to everything in the operator panel. This can be useful, for example, in performing support and maintenance. Only capital letters can be used on the command line.

---

**Note:**

The PS password does not override the PD password.

---

## 11.6 Changing Password in the Operator Panel

The password can be changed in the operator panel with the function **Change login password** for function or touch keys. When a function or touch key linked to **Change login password** is pressed a dialog box is shown, where the passwords for security levels below or at the same level as the in-logged person can be changed. See the chapter [Function Keys](#) for further information.

---

**Note:**

It is not possible to select a security level on block 0.

---

---

**Note:**

After logging out, the [PREV] key and the function **Return to previous block** for function and touch keys are ignored, to prevent unauthorized persons from accessing blocks protected by passwords.

---

## 11.7 Password Handling via USB Flash Drive

In some situations it can be convenient to use a USB Flash drive to handle a password. Not available for E1012 and E1022. This is possible by using the PWDF command under **Setup/Commands**.

Password levels are set in the configuration tool in the regular way. Then a USB Flash drive is prepared with a file named “password.txt” that contains the password for the desired security level. When the USB Flash drive is connected to the operator panel, the panel searches for the password on the USB Flash drive and logs in to the correct security level. When the USB Flash drive is disconnected, the security level is reset to the default level.

Normally, a question about creating a backup file structure is displayed when a USB Flash drive is connected. To deactivate this question, the DBAF command is entered under **Setup/Commands**.

## 12 Printouts from the Operator Panel

This chapter describes how report printouts are made in the operator panel. Different types of reports, e.g. daily reports and event reports, can easily be created for production follow-up. The following picture shows the principle for generating daily reports.

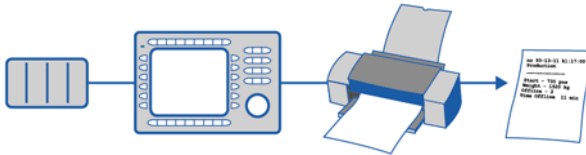

### 12.1 Connection to Printer

Printouts can be made via a serial, USB or Ethernet connection.

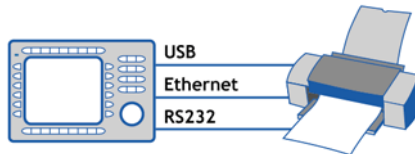

A serial printer must support IBM character set (850).

A USB printer must support the printer classes according to the table below:

Printer type	Printer class requirement	Recommended printer model
Color laser printer	USB + PCL 5c	HP LaserJet 2700
Monochrome laser printer	USB + PCL 5e	HP LaserJet 1320
Color ink-jet printer	USB + PCL 3e	HP Deskjet 5652

To print out via Ethernet, the network printer must be a shared resource in the Windows network.

---

**Note:**

Connecting a printer via Ethernet requires that a PC is connected between the operator panel and the printer.

---

**Note:**

Printing to a color laser printer via Ethernet is not supported.

---

---

**Note:**

The printer class PCL 6 is not supported at all.

---

The properties for the printer are made in the dialog under **Setup/Peripherals**. For configuration of the printer, refer to the printer manual.

---

**Note:**

E1012 and E1022 support connection to serial printer only.

---

## 12.2 Text Block Reports

Reports are created as text blocks with static and dynamic text. Dynamic objects has to be defined to print values from the process. The width of the reports is a maximum of 150 characters. The printer must support an IBM expanded ASCII character set.

When to print reports can be determined through time channels, for example. See the chapter *Text-based Presentation for Printouts and Reports* and *Time Channels* for further information.

## 12.3 Graphic Block Printouts

Graphic blocks can be printed via Ethernet using a PC server. Alternatively, a printer can be connected to the operator panel's USB port. Graphic blocks can only be printed when they are displayed on the screen (screen dump).

Commands can be entered on the command line by double-clicking on **System Signals** in the **Setup** folder in the Project Manager. By entering the command **NHD** graphic blocks will be printed on a laser printer without header (which normally includes block name, block number, date and time).

---

**Note:**

For graphic block printouts the printer's internal memory should be at least 5 MB, if point-to-point.

---

**Note:**

The alarm block, i.e. the graphic block which contains the alarm list is printed out as a text printout.

---

## 12.4 Defining the Printout

The printout is defined under the **Printout** tab in the block properties dialog, displayed by right-clicking on a block and selecting **Properties**. The parameter **Print signal** indicates the digital signal, which, when it is set to one, activates the printout of the block. A digital **Completion signal** is also indicated here, which is set to one by the operator panel when the printout is completed. If the box **Reset** is selected, the signal will be reset instead.

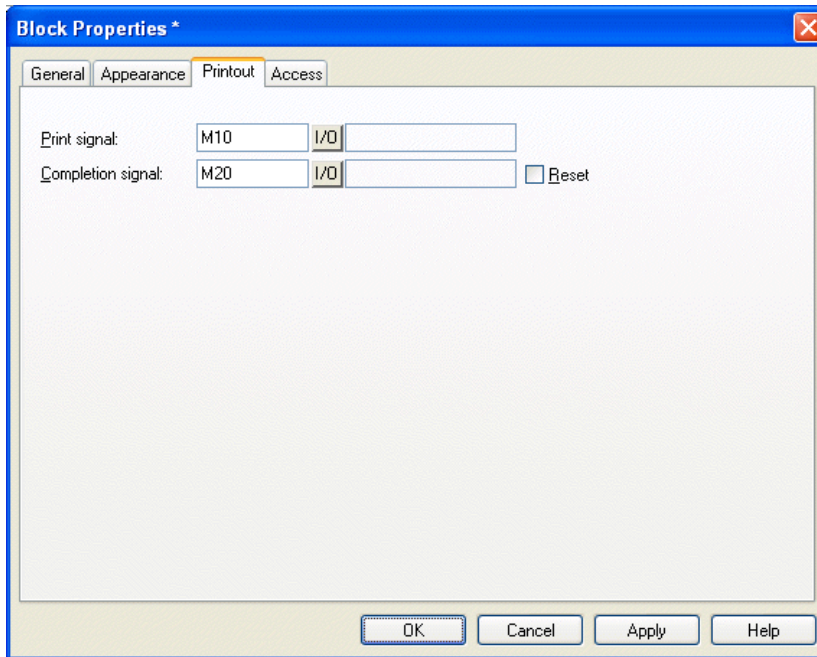

## 12.5 Printer Properties

Printer settings can be made by double-clicking on the **Peripherals** folder in the Project Manager, right-clicking on **Printer** and selecting **Properties**.

See section [Connection to Printer](#) for information about supported printer classes.

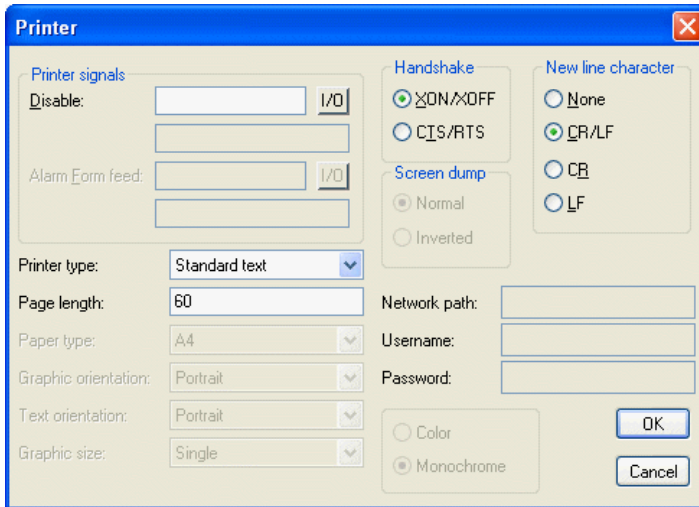

Parameter	Description
Printer Signals	<p><b>Disable:</b> A digital signal, which when set to one, stops the printout. The port where the printer is connected can then be used for other communication, e.g. Transparent mode.</p> <p><b>Alarm Form Feed*:</b> A signal that sends a form feed to the printer. When using "To Printer" for alarms, a form feed will only be sent when the page length is full, not after every single alarm. Only used for Laser and InkJet printers.</p>
Printer type*	Select standard text or installed printer, e.g. PCL Inkjet or PCL Laser.
Page length	The number of lines to be printed out before form feed. If the page length is set 0 there will be no form feed.
Paper type*	Select the paper type according to the installed printer.
Graphic orientation	Select whether the graphic printout is to be vertical or horizontal.
Text orientation*	Select whether the report printout is to be vertical or horizontal.



Parameter	Description
Network path*	Search path, using UNC naming, to network printer. The IP address cannot be included in the UNC naming.
Username*	Username to printer server.
Password*	Password to printer server.
Handshake	Select whether handshaking between printer and operator panel is to be with XON/XOFF or CTS/RTS.
New line character	Select line end character; CR/LF, CR, LF or none.
Color/monochrome*	Select if printout should be black/white or color.

\* Not available for E1012 and E1022.

For information concerning printers, see the manual for the printer.

---

**Note:**

The printer properties are used for parameters such as character set, character size and margins.

---

## 12.6 Control Codes to Printer

In text blocks control codes to the printer can be used. Enter %% followed by a number between 1 and 31. 1 to 31 are control codes to the printer. For example, entering %%12 means paper feed. See the printer manual for a description of the control codes. A command must be followed by a space. Page feed (%%12) is specified at the end of the line. The characters %% must not be used in the text. It is possible to have more than one command on a line.



## 13 Time Channels

Time control is a function for setting and resetting digital signals in relation to the real-time clock. This function is used to control events in the process at special times, e.g. starting and stopping motors, through the operator panel.

### 13.1 Defining Time Channels

Time channels can be defined by double-clicking **Time channels** in the Project Manager.

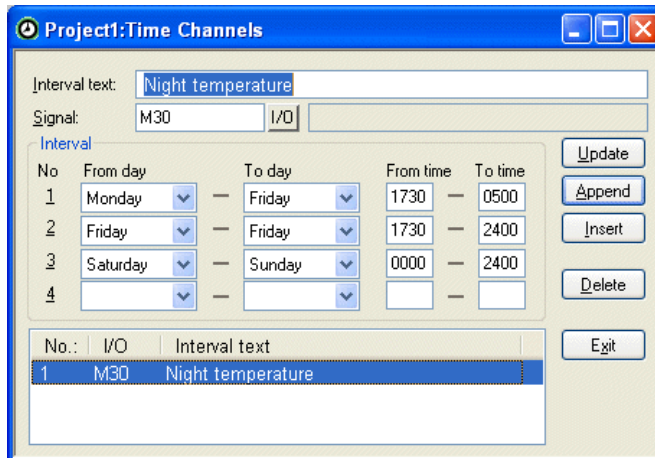

Parameter	Description
Interval text	An optional text for the time channel.
Signal	A digital signal, which is set to one during the specified time interval.
Interval	The days and times for the interval. Four different intervals can be defined for each time channel.

In the previous example, one time channel was defined. This time channel has the text **Night temperature**, and is linked to the signal **M30**. The signal will be set to one Monday to Friday between 17.30 and 05.00, Friday 17.30 to 24.00, and Saturday to Sunday between 00.00 and 24.00. During these periods, the temperature in the building will be reduced.

**Note:**

Make sure not to use the same trigger signal for two different time channels. When the first time channel is finished, its trigger signal is reset, and the second time channel will not be triggered.

## 13.2 Presentation in the Operator Panel

The time channels are shown when system block 991 is activated, either through a jump object or through a digital signal linked to the block. The values of the time channels can be read and/or changed. To change the value of the time channels when the operator panel is running, the box **Time channels** under **Setup/Online Properties** must be checked.

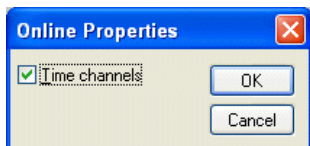

To read or change the values for a time channel, place the cursor on the desired line and press [ENTER], or point at the desired line if the operator panel has a touch screen. Press [OK] to exit the definition of the time channels. Exit the time channel menu with [PREV] or press **Cancel** if the operator panel has a touch screen. The block from which the time channel block was activated will then be shown.

## 14 Language Management

The configuration tool supports several language applications for the E1000-series' operator panels. We advise that the entire application be created in one language in the configuration tool. Using the multiple language support function, you can later easily translate all texts in the application to other languages. Translation can be performed directly in the configuration tool or the text can be exported as a text file and translated in other software. The translated file is later imported back into the configuration tool. A maximum of 10 languages can be created for an application.

---

**Note:**

Some fonts, especially some Asian fonts, use a lot of memory space. This reduces the memory size available for the project itself, and has to be taken into consideration when creating projects that will be translated. The total memory size for a project and its fonts is 12 MB.

---

Each text in the application is allocated an arbitrary index. To optimize the function and reduce the total number of texts, a text can be used several times in the application, copied and reused. These texts are linked to the same index.

The application language contains user texts and is linked to a system language that contains system texts. User texts are those texts that are entered when the project is created and system texts are those texts that already exist when a new project is created as well as texts that already exist in the operator panel's system program.

### 14.1 Unicode in the Operator Panel

Unicode is a global standard for character encoding where 16-bit values are used to represent the characters from many of the world's languages. The E1000-series operator panels only support Unicode based character sets. The Unicode characters can be used in projects and/or system texts.

Unicode has built-in support in Microsoft Windows XP and Windows 2000.

The configuration tool uses a Unicode character set to display Unicode characters in the computer's dialog boxes.

For E1012 and E1022, see section [Unicode in E1012 and E1022](#).

## 14.2 Creating Additional Application Languages

Double-click on **Multiple Languages** under **Setup** in the Project Manager. Right-click on **User Language** and select **New language**. This starts the Multiple Languages wizard, a self-descriptive sequence of dialog boxes for creating additional application languages. Follow the instructions in the respective dialog boxes and select or type the desired parameter values or name(s).



Select the number of languages to use in the application and click Next.

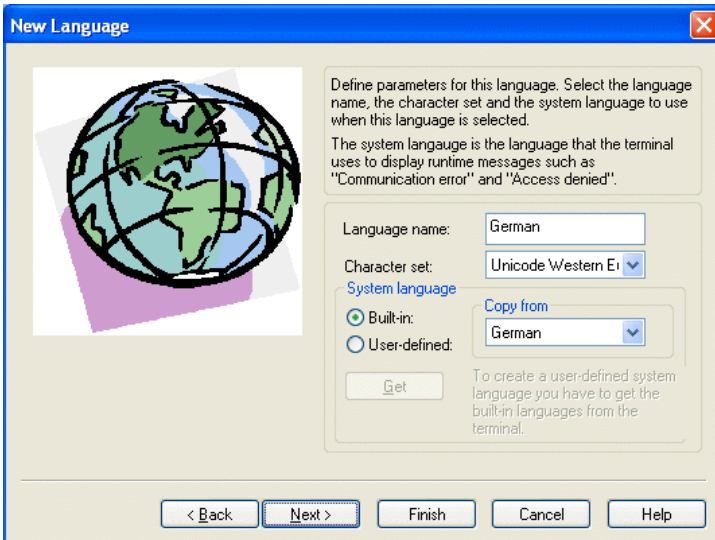

The software suggests language names. To clarify matters for the user, the name should be changed.

Under **Character set**, select the character set that will be used on the operator panel and the national characters that will be available. See the section [Country/Language](#).

Under **System language**, **Built-in** or **User-defined** can be chosen. **Built-in** entails that the system texts in the operator panel are displayed in the chosen language. **User-defined** entails that you can translate a built-in system language and link the new system language to the application language (requires that the appropriate panel be connected to the PC in accordance with the chapter [Project Transfer](#)).

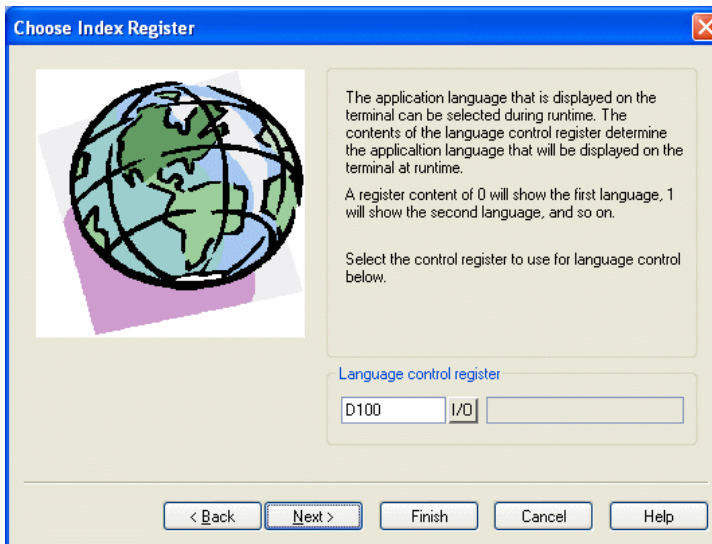

This is where the Language control register is specified. Its value (0-9) during runtime determines the application language (0-9) that the operator panel will use.

Click **Finish** to close the wizard. A structure tree is now displayed with the languages you have created.

## 14.3 Translating/Editing Texts in the Configuration Tool

Choose **Setup/Multiple Languages/Edit**, or click the **Edit**-button, , in the Language Toolbar.

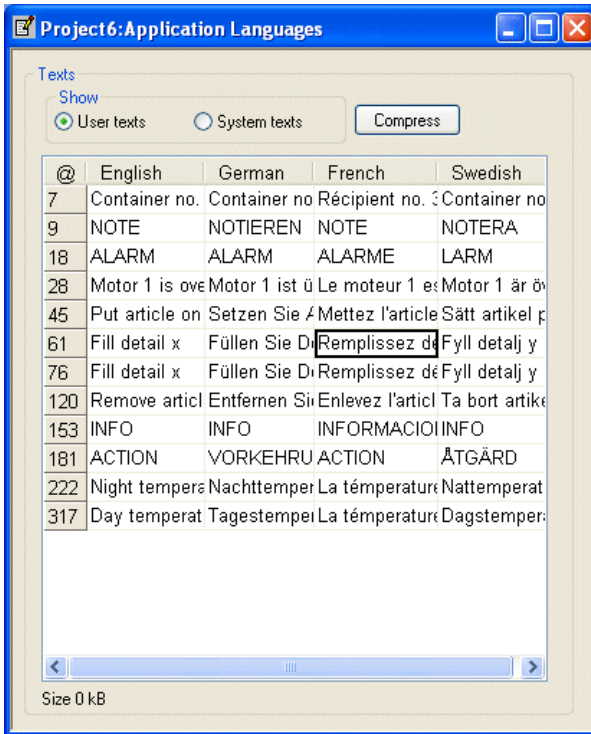

This is where the translations for the various languages are entered in the respective table cells. Move the cursor between the rows and columns with the arrow keys. You can search within the text list with the menu command **Edit/Find**.

An application language can also be exported as a text file and translated in another program, such as Excel or Notepad. The text file is thereafter imported back to the application. See the sections [Export](#) and [Import](#).

---

### Note:

When importing the translated texts, pay attention to make sure that the imported text length does not exceed the limit in the object.

---



Clicking **Compress** unites all multiple entries of the same text into one position in the list.

The indexing of the texts (the @-column in the previous picture) will be re-sorted.

**Note:**

If a text is changed after performing the **Compress** function, all occurrences this text will be changed.

## 14.4 Properties for the Application Language

Click  or double-click on **Multiple Languages** under **Setup** in the Project Manager.

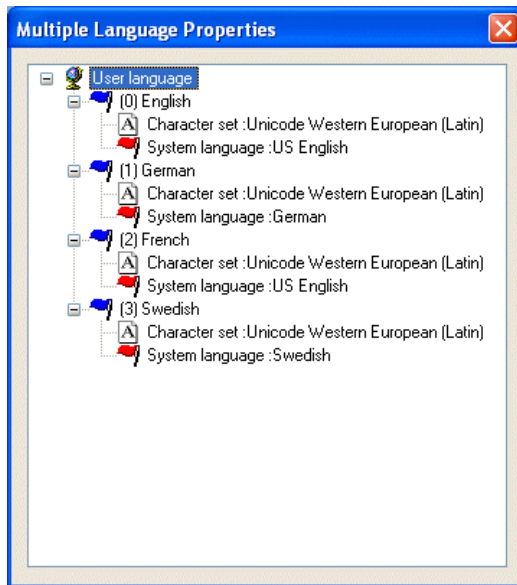

Right-click on **User Language** and select **Properties** to change the register that determines the displayed language.

When right-clicking on the language name, you can choose between the following menu commands:

Menu command	Description
New language	Creates a copy of the selected language
Character set	Chooses/edits character set
System language	Chooses system language
Delete language	Deletes the selected language

Menu command	Description
Rename	Changes name of selected language
Properties	Specifies data register with the value that determines the displayed language

Select **Character set** to change the character set for the language.

Select **System language** to change the selected system language. Right-clicking on **System language** and selecting **Properties** displays the **Extra keys C1-C4** dialog.

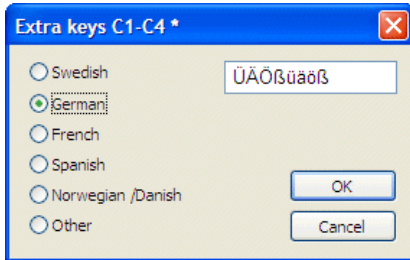

Select a language of which to display special national characters, or select **Other** and type desired characters. These characters will then be displayed on the alphanumeric keyboard, when e.g. an ASCII object is maneuvered. See the section [The Alphanumeric Keyboard](#) for further details.

## User-Defined System Languages

To create a user-defined system language, choose **User-defined**, choose the language that would like to copy from and click **Get**. The **Language Transfer** dialog box opens. Click **Receive** to retrieve the built-in system language from the operator panel. System texts are now accessible for editing under **Setup/Multiple Languages.../Edit**. You can also choose to export the texts as a text file and edit them in another program.

All system texts in the operator panel (passwords, time channels, etc.) support the multiple language application. You can use the predefined system languages or create your own (new). All types of characters that exist in the character set can be used in the application language. A text string is linked to several different objects. The maximum number of text strings for each language depends on available project memory in the operator panel.

At the bottom left of the **Application Language** dialog box, information is displayed on memory size for selected languages (language file). The information is displayed in the format X/Y. X is the utilized memory and Y is the available memory for each language (for example, 7/128).

## 14.5 Export

You can choose to export a language to Excel, for example, translate it there, and then import it back to the configuration tool.

Choose **Setup/Multiple Languages/Export**, or click the **Export**-button, , in the Language Toolbar. Choose **User texts** (or **System texts**). In the displayed dialog box, specify the name of the file to be exported and indicate if it is to be an Unicode text file.

## 14.6 Import

Choose **Setup/Multiple Languages/Import**, or click the **Import**-button, , in the Language Toolbar. Choose **User texts** (or **System texts**). The **Import multiple languages texts** dialog box is displayed. Choose the name of the text file that you would like to import. The existing language in the project is in Unicode format.

---

**Note:**

Make sure to make a backup copy of the project before importing languages, in case there are mismatches between the existing and the imported languages.

---

## 14.7 Show Index

Each object that displays text in a multiple language application is linked to an index. An index can be linked to different objects with the same texts. Choose **Setup/Multiple Languages/Show Index**, or click the **Show Index**-button, , in the Language Toolbar, to display the index number for the object texts.

## 14.8 Cross Reference

Choose **Setup/Multiple Languages/Cross Reference**, or click the **Cross Reference**-button, , in the Language Toolbar. On the displayed cross reference list you can right-click an object to edit it. The cross reference list has support for incremental searching when you specify an index number.

## 14.9 Reuse Index

Choose **Setup/Multiple Languages/Reuse Index**, or click the Reuse Index-button, , in the Language Toolbar. When **Reuse Index** is active and an object is copied, the copy will be assigned the same index. This entails that objects with the same index need only be translated once. Changes made to a text will be seen at all locations where the same index number exists.

---

**Note:**

If an object is deleted that has copies with the same index number, only the selected object is deleted.

---

## 14.10 Font Templates

The Font Template controls which font will be applied for the different text objects and languages. Not available for E1012 and E1022. Choose **Edit/Font Templates** for a summary of all the fonts used in the project. If a language is used that requires characters which are not available in the Windows True Type fonts (e.g. Arial or Times New Roman), the desired font must be selected for the affected language. Changes in the Font Template affect all the text objects connected to the particular font.

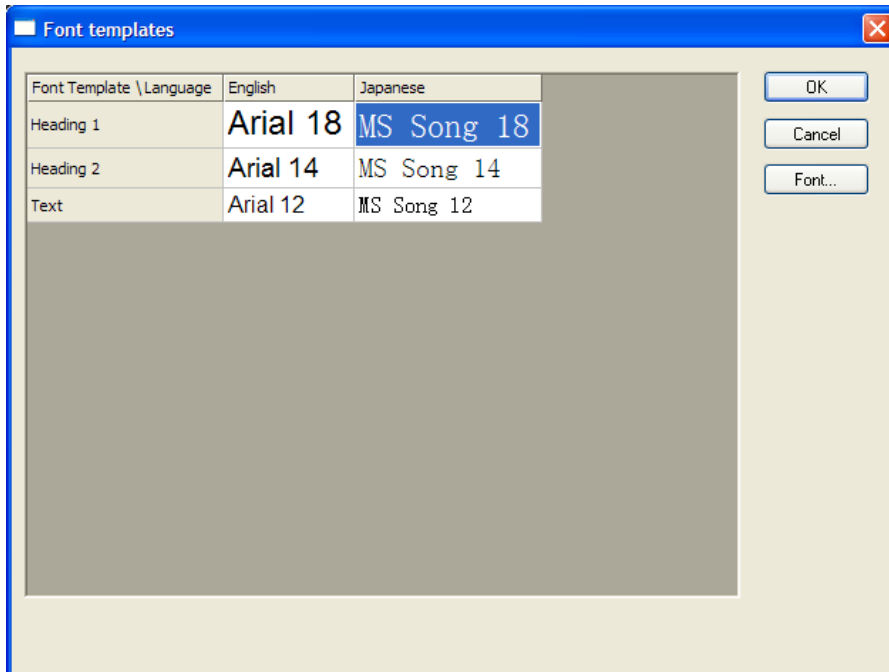

---

**Note:**

The size of the font files is added to the used project memory.

---

## 14.11 Unicode in E1012 and E1022

Unicode is a global standard for character encoding where 16-bit values are used to represent the characters from many of the world's languages. Previous standards for character encoding, such as the Microsoft Windows ANSI character set, use 8-bit character values or combinations of 8-bit values to represent the characters used in a certain language or geographical region.

In Microsoft Windows 2000 and Windows XP, IMEs (Input Method Editors) are used to permit the computer user to write in complex characters and symbols, such as those used Chinese, with a standard keyboard. The character sets installed in the computer are used. IMEs for various languages are added under **Control Panel/Keyboard/ Input language**. When new character sets are installed, all necessary characters are added to the system.

The configuration tool uses a Unicode character set to display Unicode characters in the computer's dialog boxes. Only those Unicode characters that are used in the project will be downloaded to the operator panel during the project transfer.

### Terminal Font

A character set is used in the operator panel to display Unicode characters. The character set in the panel contains approximately 35,000 characters but is not complete according to the Unicode standard. When a project is transferred to the panel, only the characters that are used in the panel are downloaded. If a character that is not available is used, it is replaced by a black square, both in the configuration tool and the operator panel. The project test that can be performed when transferring the project checks that all used characters are present in the character set in the panel.

### Character Sizes for User and System Texts

Unicode characters are processed as bitmaps (point matrices). The predefined character size is 8 x 16 pixels but can be changed. Sometimes the character size 16 x 16 must be chosen for complicated characters, such as those used in Chinese, to avoid failure of certain pixels to be displayed and that characters be misinterpreted by the operator. If a large character size is chosen, menu windows may not always have space in small panels.

### Switching between Display of Object Text and Index Number

When the T/@ button is selected on the **Language** toolbar, the configuration tool displays the index number (**@number**) in the object instead of the text. In the @ mode, new text (in ANSI/OEM, not Unicode) can be specified to link the object to a new index and release it from the other objects and the original index. By specifying @number, the object can be linked to new indexes.

## **Export and Import of Files in Unicode Format**

System and user texts can be exported and imported under **Setup/Multiple Languages**. An exported file in Unicode format can be edited in a text editor such as Notepad. Choose a Unicode font in the text editor.

When a file is exported, the ANSI/OEM or Unicode format can be chosen. If ANSI/OEM is chosen, only languages in ANSI/OEM format will be exported to a file in ANSI/OEM format. If Unicode is chosen, all languages will be exported to a file in Unicode format.

When a file in ANSI/OEM format is imported, you can choose whether or not an existing language will be updated, or if there is none previously, to add one.

When a file in Unicode format is imported, you can choose whether or not an existing language will be updated, or if there is none previously, to add one. If the existing language is in ANSI/OEM format, the imported language (in Unicode format) will be converted to ANSI/OEM form. Characters not supported by ANSI/OEM will be replaced by question marks.

## **Memory usage**

When Unicode is used, memory is allocated in accordance with the following formula:

Languages size: Each string requires  $22 + \text{total characters in the string} \times 4$  bytes.

Character set size: The character set that is transferred requires the total number of unique characters  $\times 34$  bytes, which means, for example, that transfer of 1000 characters requires 34 KB.

Memory usage for a Unicode language is the language's size + the character set's size.

## **Performance**

The drawing of Unicode characters is somewhat slower than the drawing of ANSI/OEM characters, which is primarily because Unicode characters have more pixels to be drawn.

When the operator panel is started, the Unicode character set is read into memory, which can take time if the character set is large.

## Limitations when Unicode is Used in E1012 and E1022

### Text Blocks

Text blocks are not supported when Unicode is used. If a Unicode character set is chosen in an existing project, the warning will be displayed.

### Save Recipe and Alarm History

HMI Tools File Transfer and FTP client do not support Unicode characters. The skv file that can be used to edit recipes on a PC or for alarm history will, when Unicode is used, contain index numbers (@xxx) instead of texts. You can search in the project for corresponding text in the panel. If texts are desired in the skv file, the panel project has to be changed to a character set in ANSI/OEM format.

### Dynamic Texts

Texts can be controlled via control system signals by choosing **Dynamics/Properties** for the selected object. These texts will not be converted to Unicode; question marks will be displayed instead.

### Time Channels Block

The standard block Time channels, which can be configured in RUN mode, must use the preselected character size 8 x 16. The input window will otherwise be too large for the screen and the block will not be possible to configure.



## 15 System Monitor

The system monitor is a block where the operator can view or change the values for control signals when the operator panel is running. Not available for E1012 and E1022. The values are presented as decimal, hexadecimal and ASCII values. The system monitor is always available in the operator panels. To use the system monitor when the operator panel is running, a block jump from another block to the system monitor block is created. The editing box is needed to add on control signals. This is shown when you press [ENTER] or alternatively point to the button NEW on the operator panel when the system monitor is active.

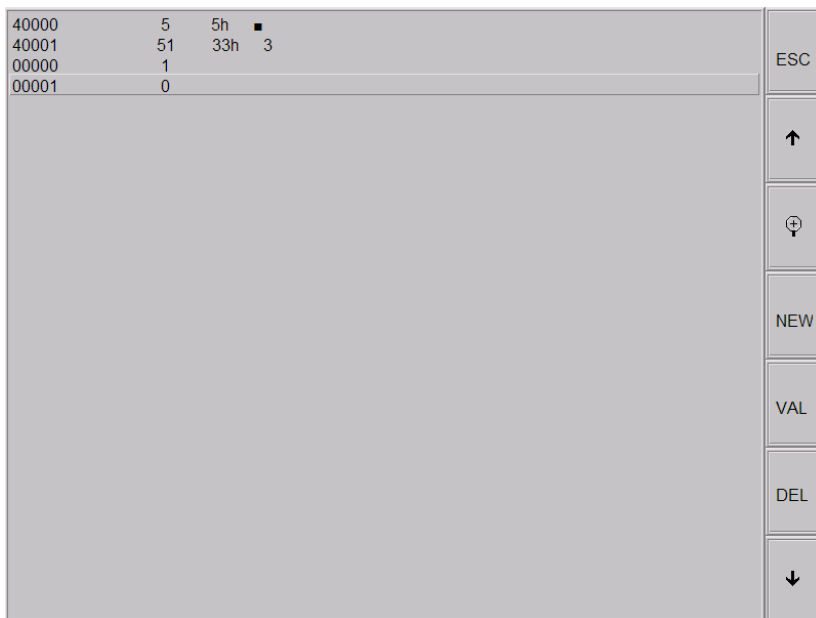



## 16 Index Addressing

With index addressing, it is possible for the operator to select from which register an object is to collect the shown value. Without index addressing an object is always connected to the same register, and only the value in this register can be shown in the object. Index addressing is set up by adding the value in the index register to the address of the register which is the analog signal in the object. In general this can be formulated as:

*Display value = the content in Register (the Object's address+the content in the Index register)*

If the content in the index register is 2 and the address of the register specified in the object is 100, the value shown in the object will be collected from address 102. If the value in the index register is changed to 3, the value in the object will be collected from address 103 instead.

Which register is to be used as the index register is defined in **Index** under the **Setup** folder in the Project Manager. Up to eight different index registers can be used in each project, and each index register can be used for more than one object.

The objects used in the project will specify whether index registering is to be used, and if so, which index register. This is done by selecting in the dialog for the object I1 to I8 in the box to the right of the indicated address signal for the object. In the example below, D10 is the analog signal and I1 is the index register used.

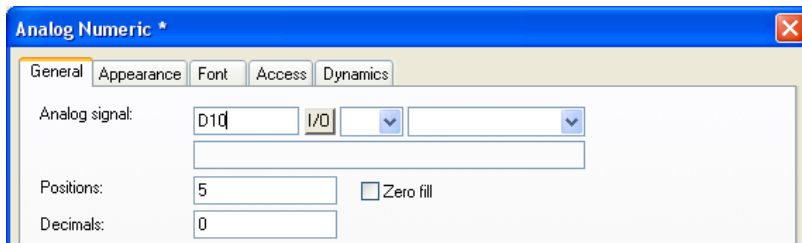

In the following example, three motors are to be controlled from one block. The torque and speed for the three motors are stored in six different registers. One of the motors will be selected in one block, and then only the current torque and speed for this motor will be shown in the block. If another motor is selected, the current torque and speed will be shown for this motor instead. This is possible with index registering.



Register D0 is defined as Index register 1 by double-clicking on **Index** under the **Setup** folder in the Project Manager. The value in the register will determine for which motor the torque and speed are to be shown.

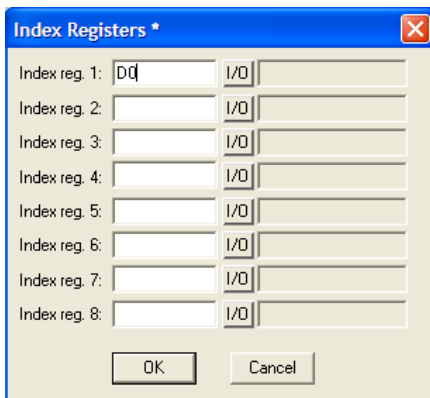

If the value is 1 in D0, the torque and speed for Motor 1 will be shown. If the value is 2 the values for Motor 2 are shown, and if the value is 3 the values for Motor 3. The value in register D0 is controlled with a Multiple choice object, where the texts Motor 1, Motor 2 and Motor 3 are shown. These three choices are also made maneuverable.

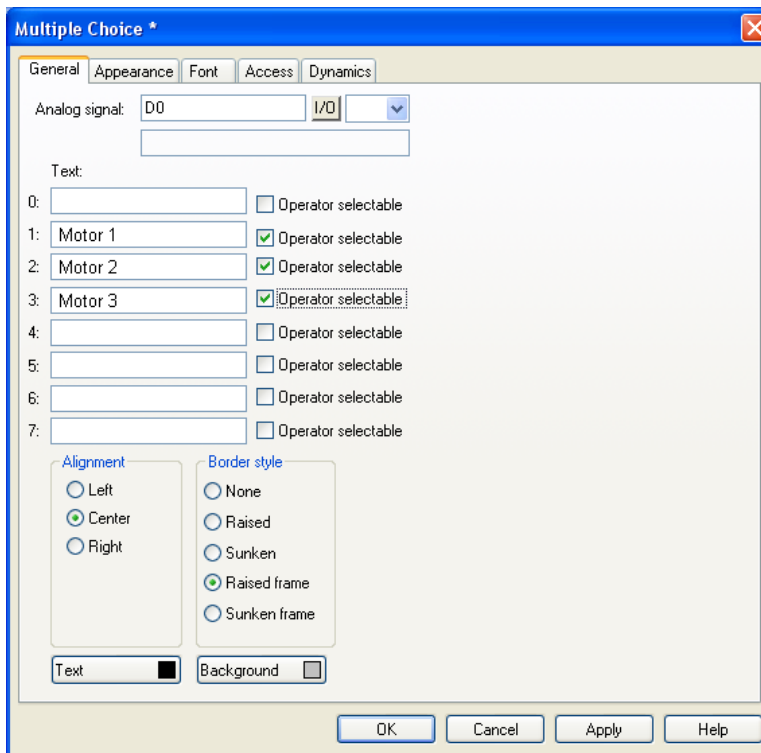

The torque and speed are shown in two numerical objects. In the object for torque, D10 is specified as the analog signal and I1 as the index register.

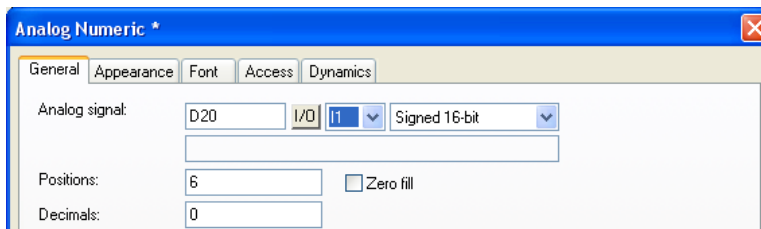

In the object showing the speed, D20 is specified as the analog signal and also here I1 as the index register.

With the maneuverable Multiple choice object it will then be possible to select the alternatives Motor 1, Motor 2 and Motor 3 in the operator panel. Depending on this choice, the values will be set to 1, 2 and 3 in register D0. The value in D0 is added to addresses for the objects which show the torque and speed. These can show the values in register D11, D12 or D13, and D21, D22 or D23.

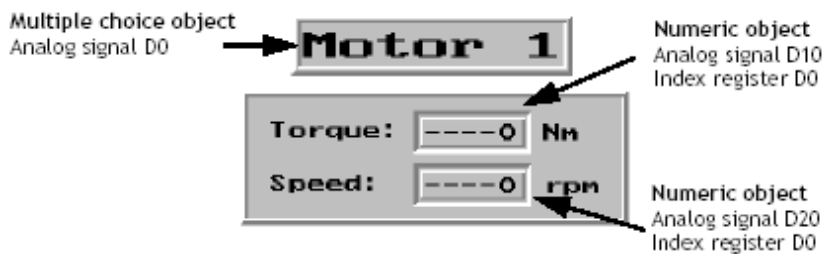

---

**Note:**

If the operator panel is connected to a BDTP network, the same index register must be stated in the server and the client because the indexing is made in the server driver.

---

# 17 Communication

This chapter describes communication with two controllers, the communication modes Transparent, Passthrough, No Protocol and modem connection.

## 17.1 Communication with Two Controllers (Dual Drivers)

It is possible to use two different drivers in the operator panel, which means that the operator panel can communicate with two different controllers simultaneously. The controllers can be connected in series to the serial ports on the operator panel and to the Ethernet via the Ethernet port.

For E1012 and E1022 connection to Ethernet is available via an Ethernet expansion module, mounted on the back side of the panel. The expansion module can only be used for communication with controllers using Ethernet drivers and to load/receive projects; not for network functions.

Addressing of the signals in the controllers is carried out as normal for each respective controller in accordance with the manual for the driver.

Double-click on the project in the Project Manager to display the Project Properties dialog.

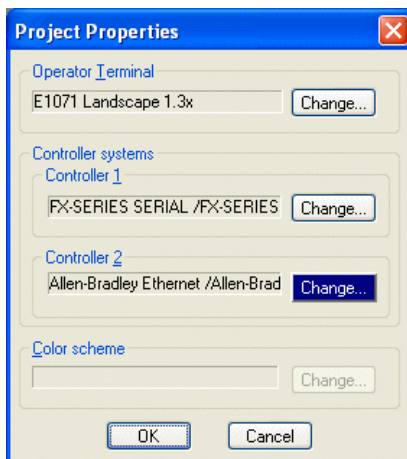

Select **Controller** by clicking on **Change** for **Controller 1** or **Controller 2**. If the selected driver for **Controller 1** does not support dual drivers, a driver for **Controller 2** cannot be selected. Click on **OK**.

Double-click on the **Peripherals** folder in the Project Manager. Drag **Controller 1** and **Controller 2** to the connection ports where the respective controllers are connected. It is possible to use RS232C, RS422, RS485 and the Ethernet port. For further information on the connection of controllers to the operator panel, see the manual for respective drivers.

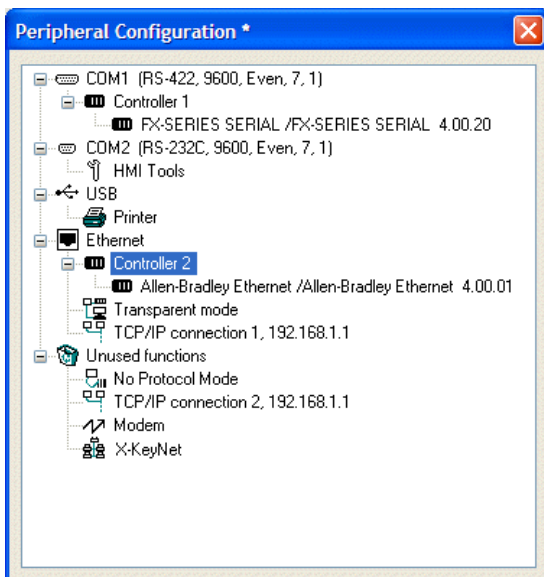

## Addressing

Addressing of the signals in the controllers is carried out as normal for each respective controller in accordance with the manual for the driver. The controller to which a created object is to be linked is selected by clicking the button corresponding to the desired controller (1 or 2) in the Controller Toolbar. Controller 1 is pre-set when a project is created or opened.



If button **1** is clicked, the signal is linked to an object created for **Controller 1**, and if button **2** is clicked, the signal is linked to an object created for **Controller 2**. Clicking the **I** links the signal to the internal variables. See section [Internal Variables](#) for further information.

It is also possible to click on the **I/O** button in the object created and select which controller the object is to be connected to from the **I/O** Browser.

To address a signal in controller 2 when controller 1 is preset, the signal must be given the addition **@2** and correspondingly **@1** for controller 1 if controller 2 is preset.



**Example:**

Controller 1 is preset. Register D0 in controller 2 is to be connected to a Bar Graph. D0@2 is entered in the field **Analog signal** in the dialog for the bar graph.

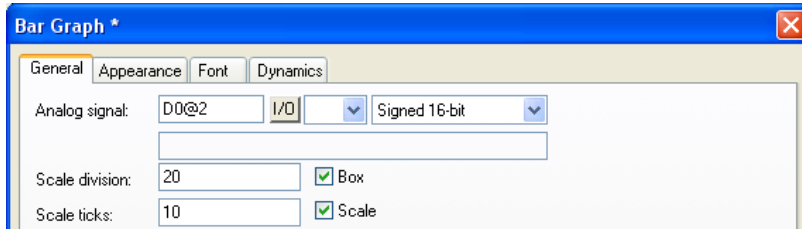
**I/O Cross Reference**

The I/O cross reference function can be used to show I/Os in a well-arranged manner for both **Controller 1** and **Controller 2**. The cross reference shows the preset controller.

**Name List**

The name list with attendant functions is supported for both **Controller 1** and **Controller 2**.

**Note:**

If communication with a controller is lost, the operator panel will continue to communicate with the other system. The operator panel will try to connect to the disconnected system every tenth second, which can affect communication with the operable controller. The interval can be changed in the parameter off-line station in the driver properties.

## Examples of Configurations where Dual Drivers are Used in the Operator Panel

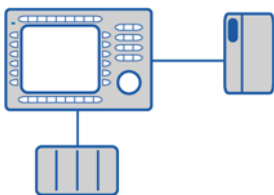

*Operator panel communicating with one controller and one frequency converter.*

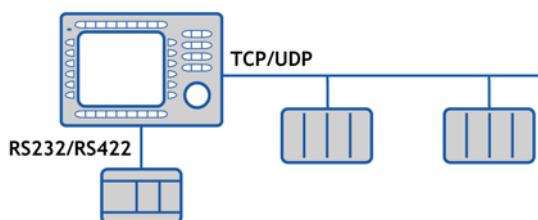

*Operator panel communicating in series with one controller via the Ethernet, and with controllers of another make.*

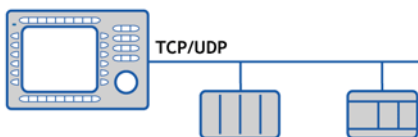

*Operator panel communicating with two controllers of different makes via the Ethernet.*

## 17.2 Data Exchange between Controllers

When two controllers are connected to one and the same operator panel (dual drivers are used in the operator panel) it is possible to exchange data (analog and digital signals) between the controllers. Likewise, two controllers can each be connected to an operator panel and still exchange data when the operator panels are connected in a BDTP network. Not available for E1012 and E1022. For addressing, see the section [BDTP](#). The signals do not have to be of the same type in the two controllers. The exchange of data takes place in a virtual data channel between controller 1 and 2. Eight different data channels can be defined. The transfer of data can take place at intervals or during events. The conditions for how the transfer is made and which interval of signals are to be transferred for each data channel are specified by double-clicking on **Controller data exchange** under the **Peripherals** folder in the Project Manager.

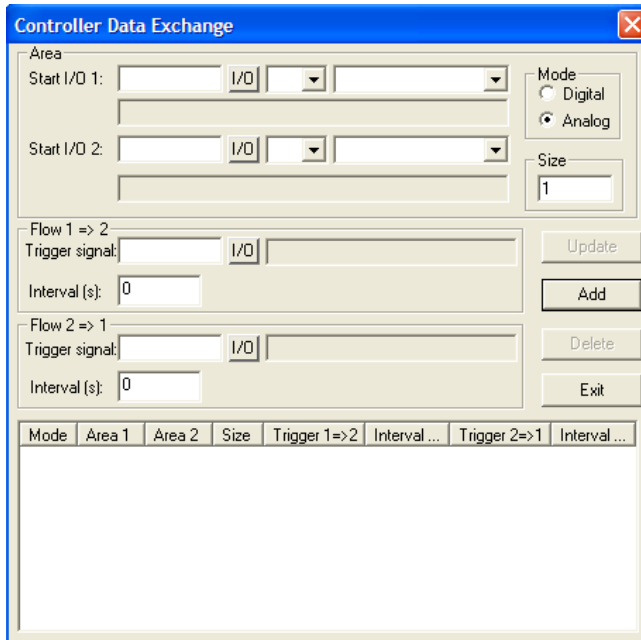

Parameter	Description
Area	Start I/O 1 and Start I/O 2 - Start address for the data channel for controller 1 and controller 2. (The subsequent fields are used to specify an index register and signal format. See the chapters <a href="#">Index Addressing</a> and <a href="#">Signal Format</a> .)
Mode	Select if the signals for the data channel are digital or analog.

Parameter	Description
Size	The number of signals to be transferred (start address + subsequent) in the data channel. The maximum number of signals for is 255.
Flow 1 => 2	<p><b>Trigger signal</b> - A digital signal which controls the data transfer from controller 1 to controller 2 for the data channel. The signal status has the following implications:</p> <p>0 - Inactive 1 - Transfer - The operator panel resets the signal when the transfer is completed.</p> <p><b>Interval</b> - The time in seconds between cyclical transfers of data channels. The interval parameter should be zero if it is not used. If the value is greater than 0 the parameter has a higher priority than the Trigger signal, and therefore a trigger signal cannot trigger transfers. The maximum number of seconds is 65,535.</p>
Flow 2 => 1	<p><b>Trigger signal</b> - A digital signal which controls the data transfer from controller 2 to controller 1 for the data channel. The signal status has the following implications:</p> <p>0 - Inactive 1 - Transfer</p> <p><b>Interval</b> - The time in seconds between cyclical transfers of data channels. The interval parameter should be zero if it is not used. If the value is greater than 0 the parameter has a higher priority than the trigger signal, and therefore a trigger signal cannot trigger transfers. The maximum number of seconds is 65,535.</p>

Click **Add** when the properties for a data channel have been defined.

---

**Note:**

Data exchange is given the same priority as other functions in the operator panel. This means that if the operator panel is occupied (with performing other functions) and a request for data exchange is made, this will affect the transfer time, and the exchange of data between the controllers will take longer than usual.

---

## 17.3 Transparent Mode

In Transparent mode a communication port (programming/printer port) on the operator panel which is not connected to the controller can be used to connect additional units working in parallel with the controller. These units can be operator panels, a PC with configuration tools for the controller, or a master operator system.

For information about whether Transparent mode will function together with the connected controller, please see the driver manual for the current driver.

### Connection of PC or Other Computer System

A PC with a configuration tool or another computer system is connected directly to a communication port on the operator panel, in this case the programming/printer port.

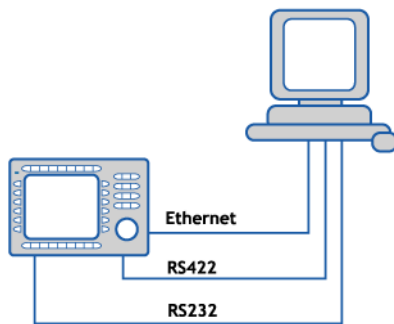

*Operator panel connected to the programming port.*

### Properties in the Operator Panel and PC

The properties for Transparent mode are made by double-clicking on the **Peripherals** folder in the Project Manager. Drag the unit **Transparent mode** to the communication port where the PC is to be connected to the operator panel. Right-click on **Transparent mode** and select **Properties**. Select **Transparent mode** (if this is supported by the driver; see the manual for the driver). The properties for the port where the PC is connected must correspond with the properties in the program in the PC (the configuration tool for the controller).

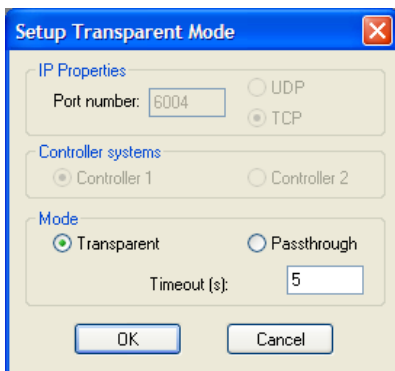

Parameter	Description
IP Properties	Only used for communication in Transparent/Passthrough mode via Ethernet. The Transparent mode unit must then be connected to a TCP/IP connection. Port number 6004, does not normally need to be changed. The required protocol, TCP or UDP, is also selected here.
Controller systems	Only used for communication in Transparent/Passthrough mode via Ethernet. The Transparent mode unit must then be connected to a TCP/IP connection. Select if Transparent/Passthrough mode is to be connected to Controller 1 or Controller 2.
Mode	Select communication mode <b>Transparent</b> or <b>Passthrough</b> . See the section <a href="#">Passthrough Mode</a> for information about Passthrough mode. <b>Timeout</b> - Specify a time in seconds after which the operator panel will return to RUN mode from the Passthrough mode if no Passthrough communication has occurred.

## Connection of Two Operator Panels in Transparent Mode

Additional operator panels can be connected to the same controller with Transparent mode. How to connect two or three operator panels is described below. Additional operator panels are connected in a similar way.

### Cable Connections

When two operator panels are to be connected to one controller the first operator panel is connected to the controller, the second to the operator panel. A cable is connected between the two operator panels as shown in the following illustration. The cable is connected between the free port on the first operator panel and the corresponding port on the second operator panel.

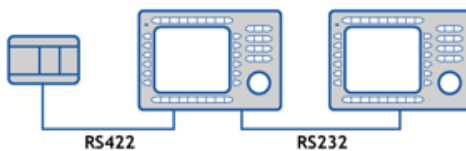

#### Cable between two operator panels for RS232 communication

9-pin D-sub female

9-pin D-sub female

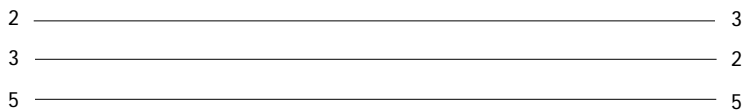

#### Cable between two operator panels for RS422 communication

25-pin D-sub male

25-pin D-sub male



## Settings in the First Operator Panel

In the configuration tool the communication settings are made under **Setup/Peripherals**. The properties for the port connected to the controller are set as normal. The settings for the port connected to the other operator panel are optional.

## Settings in the Second Operator Panel

In the configuration tool the communication settings are made under **Setup/Peripherals**. The controller should be placed on the port used to connect the second operator panel to the first operator panel. The settings for this port should be the same as for the first operator panel on the port where the second operator panel is connected.

## Transfer Speed

The transfer speed can vary between 600 and 115,200 baud. It is recommended to use the highest possible transfer speed between the operator panels to achieve optimal performance. The communication speed decreases with the number of connected operator panels according to the following table.

Number of operator panels	Access time to controller			
	Operator panel 1	Operator panel 2	Operator panel 3	Operator panel 4
1	100%	-	-	-
2	50%	50%	-	-
3	50%	25%	25%	-
4	50%	25%	12,5%	12,5%

## Connection of Three Operator Panels in Transparent Mode

A third operator panel can be connected with a cable to Panel 2 in the network as shown in the below diagram. The properties for the third operator panel should be the same as the properties in the second operator panel.

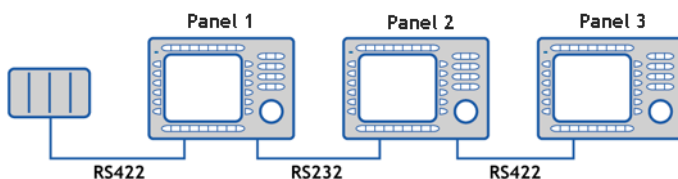



## 17.4 Passthrough Mode

With the Passthrough mode function it becomes possible to set the operator panel in a mode which enables communication between the configuration tool for the connected controller on a PC and the controller to be established through the operator panel. This is a joint function with the Transparent mode function and in similarity with Transparent mode only supports one controller. This means that Transparent or Passthrough mode can only be used on one of the operator panel's communication ports. When Passthrough mode is activated and the PC communicates with the controller through the operator panel, communication between the operator panel and connected controller will stop. This is the difference between Passthrough and Transparent mode. An operator panel where communication in Passthrough mode is in progress becomes locked for the operator, and only shows an empty display with the text Passthrough.

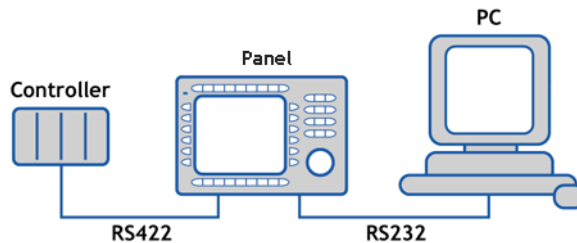

*Operator panel connected to the programming port.*

Passthrough mode for one of the connected controllers is activated and deactivated from the program HMI Tools Connect, which is available as an icon in the program group HMI Tools. See the manual for HMI Tools.

## Properties in the Operator Panel and PC

The properties for Passthrough mode are made by double-clicking on the **Peripherals** folder in the Project Manager. Drag the unit **Transparent mode** to the communication port where the PC is to be connected to the operator panel. Right-click on **Transparent mode** and select **Properties**. Select **Passthrough mode** (if this is supported by the driver; see the manual for the driver). The properties for the port where the PC is connected must correspond with the properties in the program in the PC (the configuration tool for the controller).

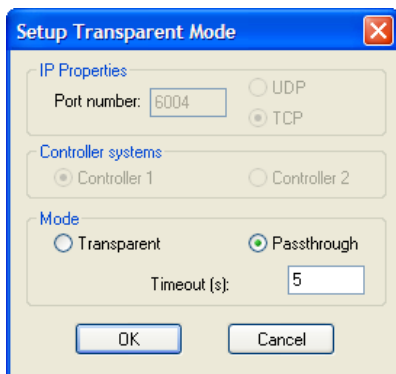

Parameter	Description
IP Properties	Only used for communication in Transparent/Passthrough mode via Ethernet. The Transparent mode unit must then be connected to a TCP/IP connection. Port number 6004, does not normally need to be changed. The required protocol, TCP or UDP, is also selected here.
Controller system	Only used for communication in Transparent/Passthrough mode via Ethernet. The Transparent mode unit must then be connected to a TCP/IP connection. Select if Transparent/Passthrough mode is to be connected to Controller 1 or Controller 2.
Mode	Select communication mode Transparent or Passthrough. Timeout - Specify a time in seconds after which the operator panel will return to RUN mode from the Passthrough mode if no Passthrough communication has occurred.

Passthrough mode can be used both through serial and Ethernet communication.

## 17.5 The Operator Panel as a Communication Interface (No Protocol Mode)

*No protocol mode* is used to connect different controllers, or to connect external units such as barcode scanners or weighing instruments to the controller. The controller controls what is to be sent to the communication port. Data entering the communication port is entered directly in the controller register. Communication takes place with the transfer of the data register area according to the following control block.

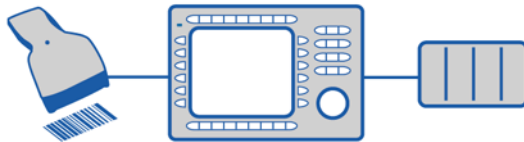

Double-click on **Peripherals** in the Project Manager.

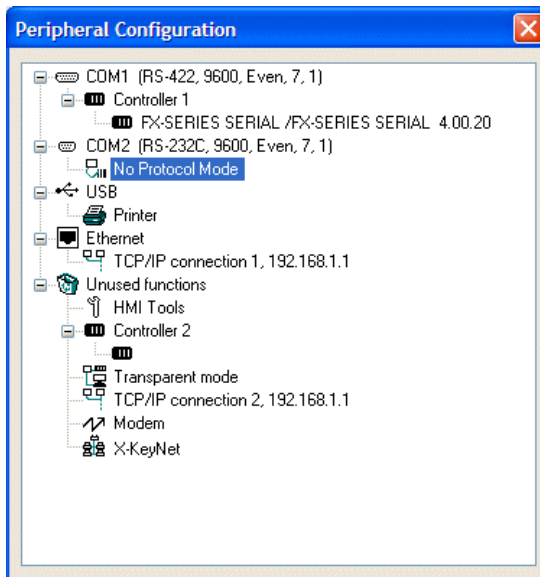

Right-click on **No Protocol Mode** and select **Properties**.

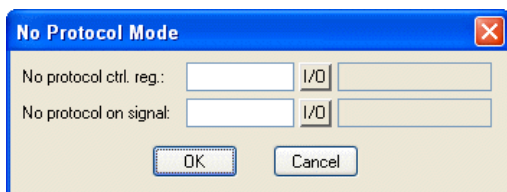

### No protocol ctrl. reg.

The first control register used in No protocol mode.

Register	Description
Ctrl. reg. 0	<i>Start register for the transmission data buffer.</i> The first register in the buffer area contains the total number of bytes to be sent. The following registers contain the data to be sent. The maximum buffer size is 127 registers = 254 bytes.
Ctrl. reg. 1	<i>Command register for transmission.</i> Set to 1 by the controller when transmission is requested. Set to 0 by the operator panel when transmission is completed.
Ctrl. reg. 2	<i>Start register for the reception data buffer.</i> The first register in the buffer area contains the total number of bytes received. The following registers contain the received data. The maximum buffer size is 127 registers = 254 bytes.
Ctrl. reg. 3	<i>Command register for reception.</i> <ul style="list-style-type: none"> <li>- Set to 0 by the controller when it is ready to receive.</li> <li>- Set to 1 by the operator panel when the message is available.</li> <li>- Set to -1 (FFFF) on error message (e.g. too short).</li> <li>- Set to 2 by the controller when clearing of the port buffer is required.</li> <li>- Set to 3 by the operator panel when clearing of the port buffer is completed.</li> </ul> The port buffer is automatically cleared on start up and when switching between Transparent mode and No protocol mode, i.e. the register receives the value 3.
Ctrl. reg. 4	<i>End code (1 or 2 bytes) on the received message.</i>
Ctrl. reg. 5	<i>Length of the received message. If 0, the end code is used.</i>

### No protocol on signal

A digital signal for switching between No protocol mode and Transparent mode, for example to dial up a computer and send a message.

In the **Peripherals** dialog, drag the unit **No protocol mode** to the communication port to use. Right-click on **No protocol mode** and select **Properties** to define which register is to be the first control register in the transfer area. This and the five following registers are used as control registers.

The controller can switch between No protocol mode and Transparent mode while operating. Specify a digital signal for the parameter **No protocol signal**.

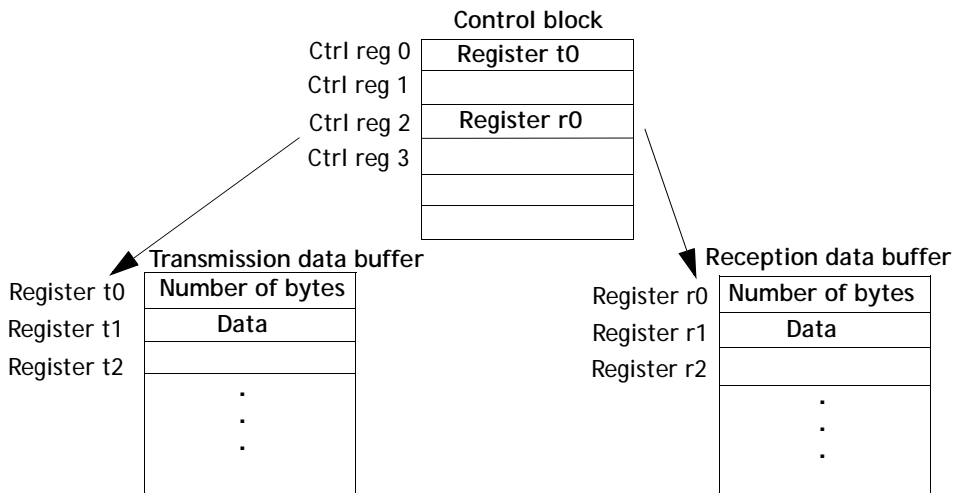

### Example of using No Protocol mode

The following example describes how No Protocol mode can be used for a weighing system. The diagram below shows a three-stage block diagram for the communication.

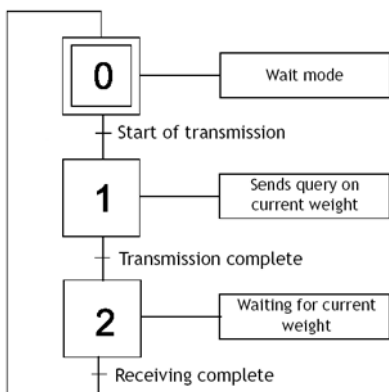

The operator panel functions as a master system for the weighing system, i.e. it continuously asks for the current weight. The protocol appears as follows.

Operator panel

|STX|?|CR|LF|

Weighing system

|STX|Weight in kg|CR|LF|

## 17.6 Modem Connection

A modem can be used to create a dial-up connection to a PC. The properties for the connection are made by double-clicking **Peripherals** in the Project Manager. Right-click on **Modem** and select **Properties**.

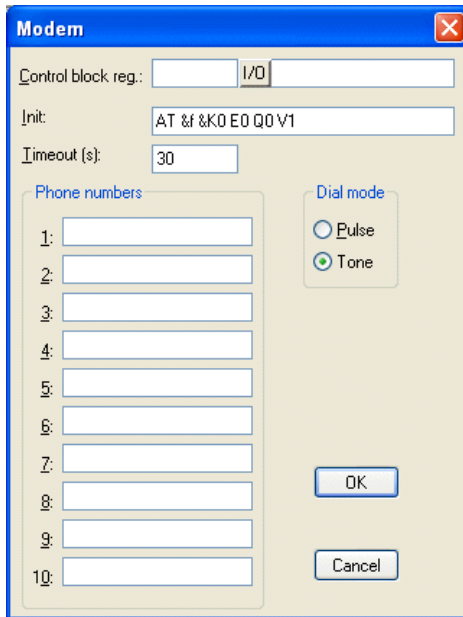

### Control block reg.

The communication is established with three control registers in a control block. The first register in the control block is defined in the **Control block reg.** in the dialog. The functions of the control registers are described in the following table.

Register	Description
Ctrl. reg. 0	<p>Contains commands describing how the controller is to dial up and establish communication.</p> <p>0 Wait for command.</p> <p>1-10 Dial up with the phone number entered in the field Phone No 1-10. Maximum of 40 characters.</p> <p>11 Dial up with a phone number stored in the controller. This number is stored as an ASCII string, which begins in the third control register and the following registers. The string can contain a maximum of 40 characters, i.e. 20 registers. It is not necessary to use all the registers. The last register read must contain the ASCII code 0.</p> <p>101-110 An initiation string is sent to the modem. Enter Hayes modem command commands in the field Phone No 1-10. Command 101 sends the string in the field Phone No 1, etc.</p> <p>111 An initiation string stored in the controller is sent to the modem. Enter Hayes modem commands beginning in the third control register. See command 11 for details.</p> <p>255 Hang up command.</p>
Ctrl. reg. 1	<p>The second control register is used as a status register. It contains the results of the modem commands. The status register can contain the following:</p> <p>Status codes</p> <p>0 Command executed successfully.</p> <p>1 Dialling in progress.</p> <p>2 Modem has established connection.</p> <p>3 Modem detected a ring signal.</p> <p>Error codes</p> <p>101 No connection.</p> <p>102 Modem detected lost carrier.</p> <p>103 Unspecified error from modem.</p> <p>104 Modem gets no dial tone.</p> <p>105 Busy when dialling.</p> <p>106 No answer when dialling.</p> <p>107 No reply from modem.</p> <p>255 Unknown error/status.</p>
Ctrl. reg. 2	<p>The operator panel can dial up with a phone number stored in the controller. This number is stored as an ASCII string, which begins in the third control register and the following registers. The string can contain a maximum of 40 characters, i.e. 20 registers. It is not necessary to use all the registers. The last register read must contain the ASCII code 0.</p>



**Init:**

Modem initiation string

**Timeout**

The number of seconds before the line is disconnected when idle. The default value is 30 seconds. A value between 15 and 600 seconds can be given.

**Dial mode:**

Choose between pulse and tone.

**Phone numbers 1-10:**

Complete phone number for the dial-up.



## 18 Network Communication

This chapter describes how operator panels communicate in a network via TCP/IP (Transmission Control Protocol/Internet Protocol). TCP/IP is a standardized set of protocols which enable sharing with other systems and units. The operator panels can be connected in a network in many different ways, through Ethernet or serially. Not available for E1012 and E1022.

The operator panel's built-in Ethernet port can be used for TCP/IP connections. Connections are made according to Ethernet standards. The expansion module that is available for E1012 and E1022 can only be used for communication with controllers using Ethernet drivers and to load/receive projects; not for network functions.

The operator panel network is a client/server network. Only clients can access data in the network. Servers only supply data to clients. An operator panel can be both a client and server at the same time, in order to both supply data and access data from other operator panels. A maximum of 20 different clients can access data from the same server. A client can access data from up to 16 different servers.

All operator panels must be assigned an IP address. IP addresses from 192.168.0.0 to 192.168.254.254 are recommended for internal networks.

It is possible to use standardized Internet tools, such as a web browser, an e-mail server, an FTP client and a VNC client, with the operator panel. A web page can be created in the PC and downloaded to the operator panel. The web page can contain real-time data from the controller or the operator panel. Values can be changed, signals can be set, alarms can be acknowledged etc. through scripts, via Internet, using a web browser. The operator panel can be accessed and controlled remotely by using a VNC client.

The operator panel can also send e-mail for special events such as alarm and status reports.

## 18.1 Examples of Possible Networks

### Example 1

This Ethernet network is designed for one controller with several operator panels.

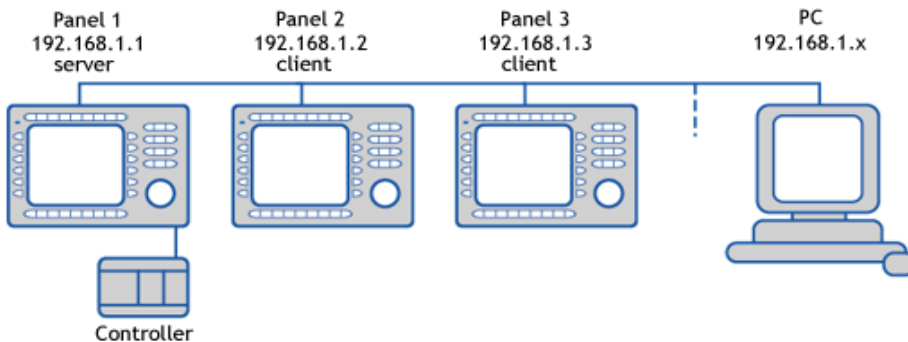

#### Panel 1 (192.168.1.1)

Operator panel 1 must be a server. Clients have access to the controller through the server.

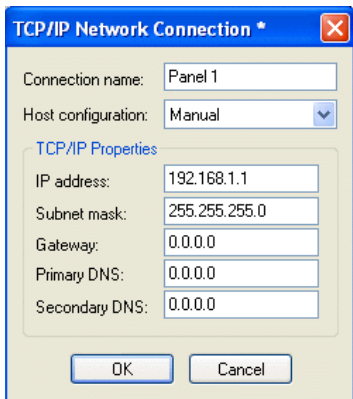

Setup/Network/TCP/IP Connections

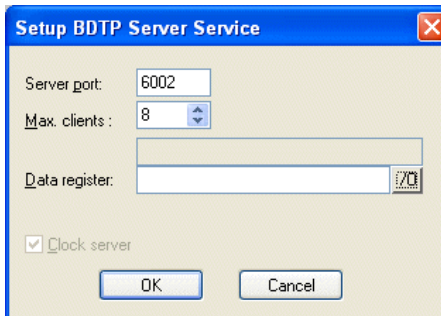

Setup/Network/Services  
Select BDTP server and click Edit...

**Panel 2 (192.168.1.2)**

Operator panel 2 must be a client. A client has access to the controller connected to the server.

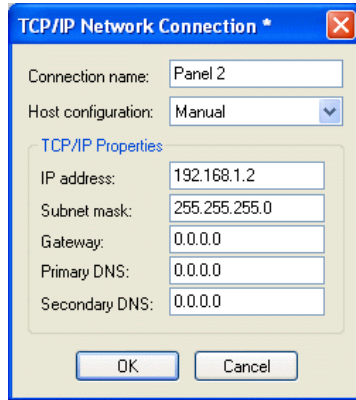

Setup/Network/TCP/IP Connections

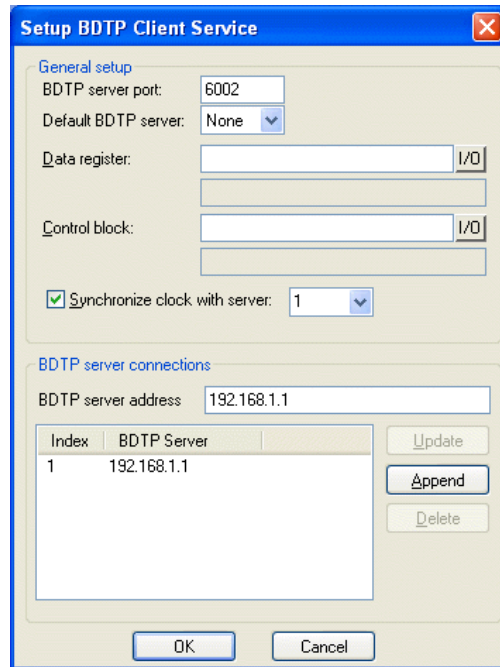

Setup/Network/Services  
Select BDTF client and click Edit...

### Panel 3 (192.168.1.3)

Operator panel 3 must be a client. A client has access to the controller connected to the server.

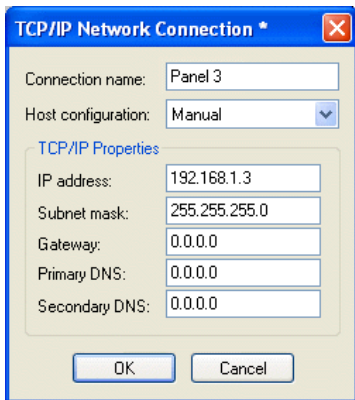

Setup/Network/TCP/IP Connections

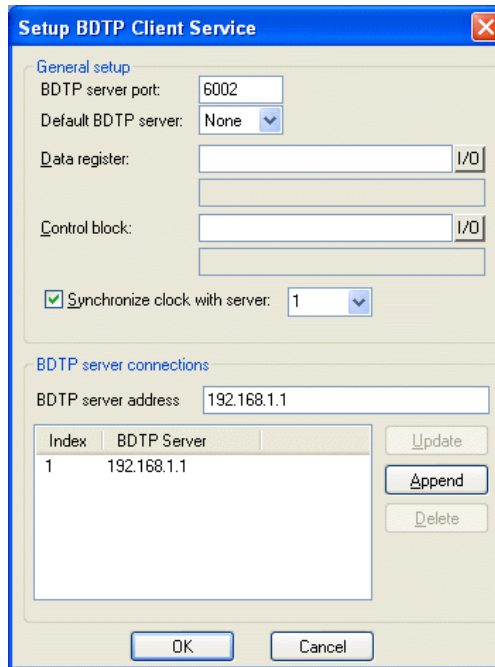

Setup/Network/Services  
Select BDTP client and click Edit...

A PC can be connected to transfer projects to the operator panels. The PC can be connected either through the Ethernet port, or to one of the serial ports on one of the operator panels. Using the Ethernet port is recommended.

## Example 2

This Ethernet network is designed for several controllers and operator panels in a network. The controllers in this example use different drivers, driver X and driver Y.

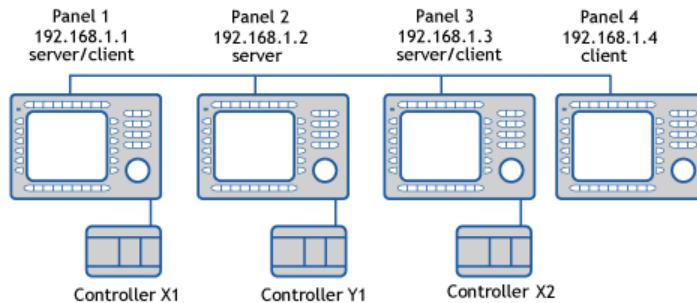

### Panel 1 (192.168.1.1)

The operator panel 1 is a server/client with the driver X and therefore has access to data from all servers with the same driver, as well as being able to provide data to other clients with the same driver. The operator panel 1 can access the connected Controller X1. The operator panel 1 cannot access the operator panel 2 due to different driver, and neither can it access the operator panel 4 which is set up as a client, not a server. This means that the operator panel 1 can access the controllers X1 and X2.

### Panel 2 (192.168.1.2)

The operator panel 2 is a server with the driver Y, which can provide data to clients with the same driver. The operator panel 2 also has access to the connected Controller Y1. However, the operator panel 2 cannot access any other operator panels since it is only set up to be a server, not a client. This means that the operator panel 2 only has access to the local Controller Y1.

### Panel 3 (192.168.1.3)

The operator panel 3 is a server/client with the driver X and therefore has access to data from all servers with the same driver, as well as being able to provide data to other clients with the same driver. The operator panel 3 has access to the connected Controller X2. The operator panel 3 cannot access the operator panel 2 due to the different driver, and neither can it access the operator panel 4 which is set up as a client, not a server. This means that the operator panel 3 can access the controllers X1 and X2.

**Panel 4 (192.168.1.4)**

The operator panel 4 is a client with the driver Y, which can access data from all servers with the same driver. This means that the operator panel 4 can access the Controller Y1.

Data can be exchanged between the controllers by using control registers. See the sections *BDTP Client* and *BDTP Server*.

The function for data exchange are also used for data exchange between two controllers as described in the section *Data Exchange between Controllers* in the previous chapter.

## 18.2 Network Communication through Ethernet

Double-click on **Peripherals** in the Project Manager to open the Peripheral Configuration dialog.

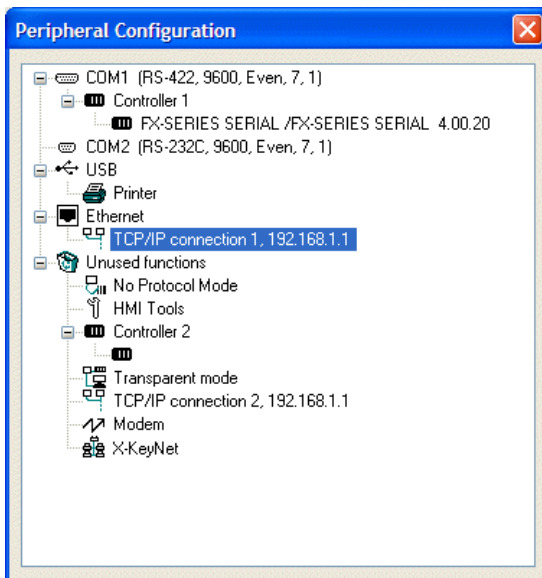



## Properties

Select **TCP/IP Connection 1**, right-click and select **Properties** to enter the properties for the TCP/IP network.

The screenshot shows a standard Windows-style dialog box titled "TCP/IP Network Connection". It features a close button in the top right corner. The main area contains several input fields: "Connection name" (empty), "Host configuration" (a dropdown menu currently showing "Manual"), and a section titled "TCP/IP Properties" which includes five text boxes for "IP address" (192.168.1.1), "Subnet mask" (255.255.255.0), "Gateway" (0.0.0.0), "Primary DNS" (0.0.0.0), and "Secondary DNS" (0.0.0.0). At the bottom of the dialog are two buttons: "OK" and "Cancel".

Setup/Network/TCP/IP Connections

### Connection name

Enter a name for the connection. The parameter is optional.

### Host configuration

Select **Manual** to use the TCP/IP properties made in the dialog. Select the other alternatives when a server provides the operator panel with one or several of the TCP/IP parameters.

### IP address and Subnet mask

State the node's network identity. Connection in a network is made according to Ethernet standards. For a local network between the operator panels, using the addresses 192.168.0.0 – 192.168.254.254 is recommended.

### Gateway

Specify the network device in the local network that can identify other networks.

### Primary DNS and Secondary DNS

State the servers containing information on a part of the DNS database.

Click **OK** after all properties have been made.

## Ethernet Connections

The section below shows two examples of Ethernet connections.

### Connection between Two Operator Panels with Twisted Pair Cable (TP)



The maximum length between the operator panels is 100 m. The cable is a CAT5 (cross-coupled) pair twisted cable, screened or not screened, equipped with RJ45 connectors.

**Note:**

If the communication does not work properly and the green LED does not light up, then connections 3 and 6 are probably switched.

### TCP/IP Properties in the Nodes

Node 1

The screenshot shows the 'TCP/IP Network Connection' dialog box for Node 1. The 'Host configuration' is set to 'Manual'. The 'TCP/IP Properties' section contains the following values: IP address: 192.168.1.1, Subnet mask: 255.255.255.0, Gateway: 0.0.0.0, Primary DNS: 0.0.0.0, and Secondary DNS: 0.0.0.0. There are 'OK' and 'Cancel' buttons at the bottom.

Setup/Network/TCP/IP Connections

Node 2

The screenshot shows the 'TCP/IP Network Connection' dialog box for Node 2. The 'Host configuration' is set to 'Manual'. The 'TCP/IP Properties' section contains the following values: IP address: 192.168.1.2, Subnet mask: 255.255.255.0, Gateway: 0.0.0.0, Primary DNS: 0.0.0.0, and Secondary DNS: 0.0.0.0. There are 'OK' and 'Cancel' buttons at the bottom.

Setup/Network/TCP/IP Connections

## Connection of Two or More Operator Panels with Twisted Pair Cable

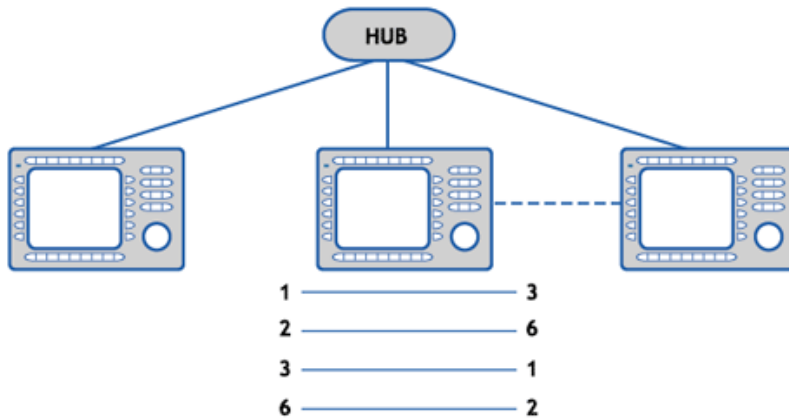

The maximum length between the operator panel and hub is 100 m. The number of operator panels per hub is limited by the number of connections to the hub. The cable is a CAT5 pair twisted cable, screened or not screened, equipped with RJ45 connectors.

### TCP/IP Settings in the Nodes

Node 1

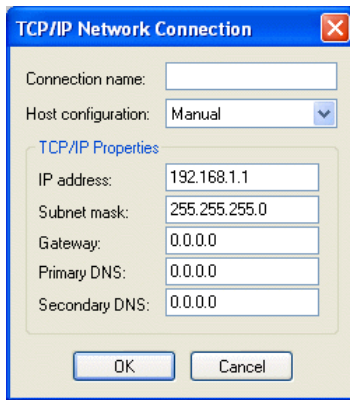

Setup/Network/TCP/IP Connections

Node 2

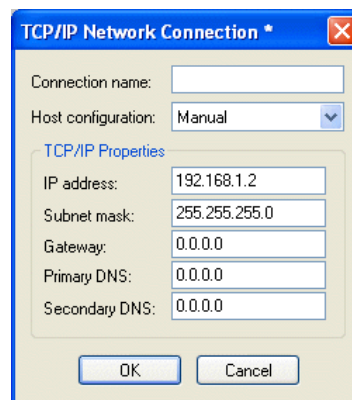

Setup/Network/TCP/IP Connections

## 18.3 Serial Network Communication/PPP

Not available for E1012 and E1022.

### How to Make a Connection

Double-click on **Peripherals** in the Project Manager. Drag **TCP/IP Connection 2** to **COM1** or **COM2**. The blinking arrows indicate where it is possible to drop it.

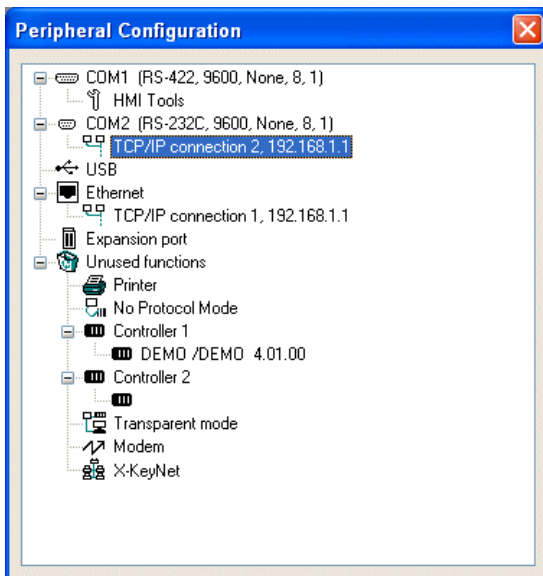

---

**Note:**

The parity setting on the port connected to the TCP/IP connection must be NONE.

---

## Setup

Select **TCP/IP Connection 2**, right-click and select **Properties** to enter the properties for the TCP/IP network.

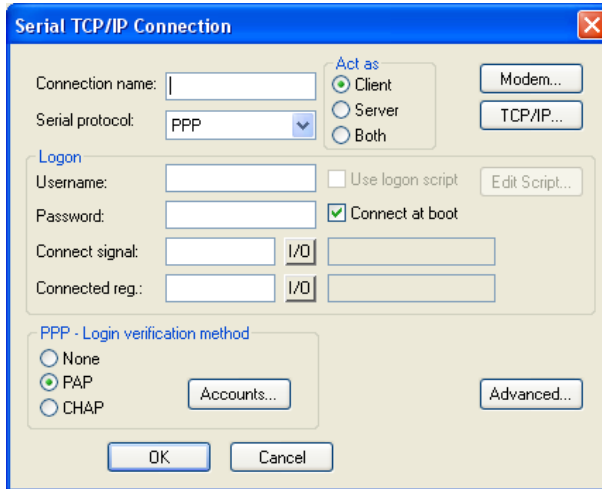

Setup/Peripherals

Right-click on TCP/IP Connection placed on serial port and select Properties.

### Connection name

Enter a name for the connection. The parameter is optional.

### Serial protocol

The protocol PPP is used for serial communication.

### User name

State the user name to use when logging in to remote network.

### Password

State the password to use when logging in to remote network.

### Connect signal

The digital signal which establishes the connection when it is set to one and disconnects when it is reset.

### Connected reg.

Analog register, which can have the following status.

- 0        Disconnected (PPP Client)
- 1        Waiting for a connection (PPP Server)
- 2        Connected as a PPP Client
- 3        Connected as a PPP Server
- 7        Connection error

### Connect at boot

For PPP connections, the operator panel can automatically connect to another operator panel or PC at start-up.

### PPP - Login verification method

Select method to validate the user identity. Does not normally need to be changed.

### Accounts

Define who is allowed to access the services. See the section [Network Accounts](#) for more information.

### Act as

Select if the operator panel is to act as a PPP client and/or PPP server, i.e. if the operator panel is to dial up a remote network or be dialed into from a remote host.

### Modem

The parameters under **Modem** are indicated if the connection is made through a modem. Use a standard modem cable to connect to the modem.

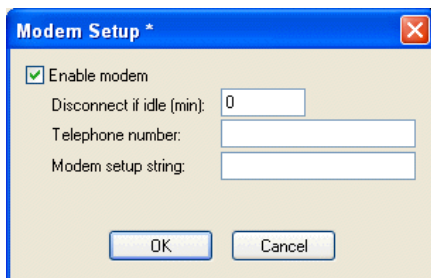

Setup/Peripherals

Select TCP/IP Connection placed on serial port and click Edit.

Now click the button **Modem...**

### Enable modem

Check if a modem is used.

### Disconnect if idle (min)

Disconnects if the connection has been idle for the given number of minutes. 0 means that the connection is never disconnected.

### Telephone number

State the telephone number to be dialed.

### Modem setup string

String which initiates the modem. For further information, refer to the documentation for the modem.

## TCP/IP

Parameters for TCP/IP connection. When the operator panel is connected to a remote host, the parameters IP address, Subnet mask and Gateway are overwritten by the settings under **Advanced...**

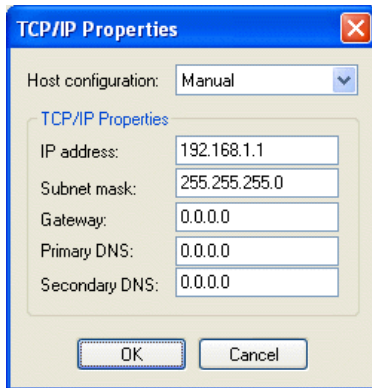

Setup/Network/TCP/IP connection placed on serial port  
Click on the button TCP/IP..

### Host configuration

Select **Manual** to use the TCP/IP properties made in the dialog. Select the other alternatives when a server provides the operator panel with one or several of the TCP/IP parameters.

### IP address and Subnet mask

State the node's network identity. Connection in a network is made according to Ethernet standards. For a local network between the operator panels, using the addresses 192.168.0.0 – 192.168.254.254 is recommended.

### Gateway

Specify the network device in the local network that can identify other networks on the Internet.

### Primary DNS and Secondary DNS

State the servers containing information about a part of the DNS database.

## Advanced

By selecting **Advanced** it is possible to define additional parameters.

### Use VJ compression of IP headers

Compression of IP headers. Does not normally need to be changed.

### Request/provide remote address

The request/providing of the remote node's IP address. Should be 0.0.0.0 if you want the IP address provided from the remote node.

### Use remote address as gateway

Checked to let the remote node's IP address be the gateway, i.e. the connection port to another network. The default setting is OFF.

---

**Note:**

If the parameter **Use remote address as gateway** is not checked and a sub network is used, the communication with the network will not function. This also means that e-mail cannot be sent from the operator panel, but that it is possible to login to the operator panel from the outside, e.g. with a FTP client or web browser.

---

### Request/provide local address

The request/providing of the remote node's IP address. Should be 0.0.0.0 to use the IP address provided from the remote node.

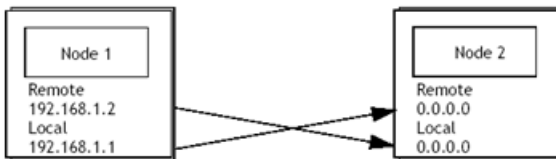

---

**Note:**

When a panel acting as PPP client tries to send e-mail to a PPP server, and cannot get a connection, the PPP client will try to connect 5 times with an interval of 2 minutes. Once the connection is established, it will try to send the e-mail. If it does not success, it will try to resend the e-mail 5 times with an interval of 50 seconds.

---

---

**Note:**

After downloading a project with PPP settings for the first time, it is recommended to turn the power off the panel, and then turn it back on again, to avoid communication problems that sometimes occur when using PPP.

---



## Serial Connection

PPP Connection between an Operator Panel and a PC

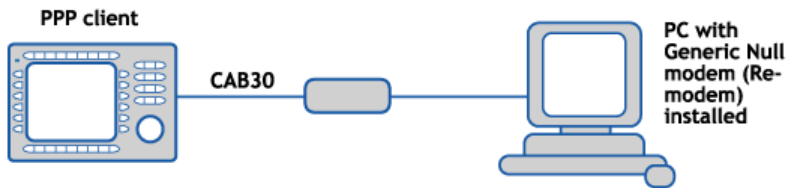

Properties in the Operator Panel

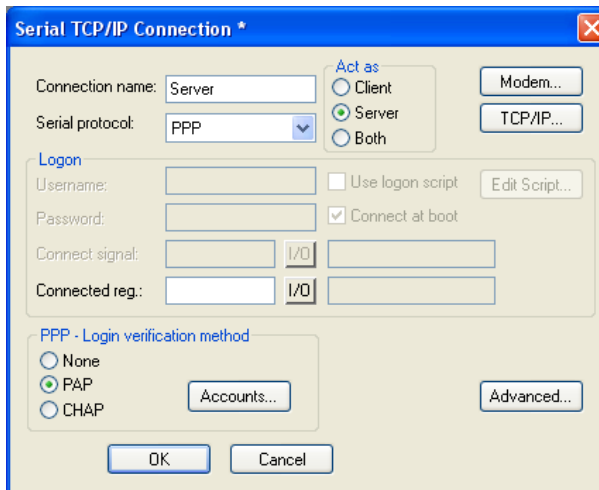

Properties under TCP/IP (IP Address, Subnet mask and Gateway) are of no importance in this case. PPP will change the parameters.

Setup/Peripherals

Select TCP/IP Connection placed on serial port.

Please refer to the PC's operating system manual for PC instructions.

## 18.4 Network Services

Double-click on **Network Services** in the **Network Connections** folder in the Project Manager to select the services the operator panel is to provide in the network. Checking a service activates it. To enter properties for the selected service, click **Edit**.

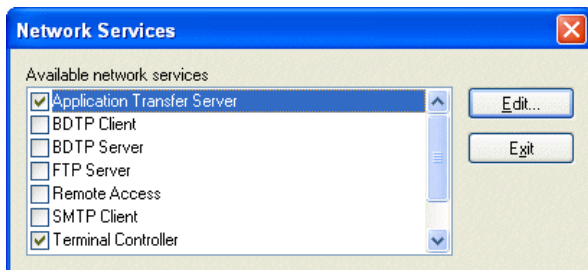

### Application Transfer Server

Transfer of projects through TCP/IP. Select **Application transfer server** in the list and click **Edit** to enter the number of the port to enable the transfer. Does not normally need to be changed.

### BDTP

BDTP is a protocol which uses client/server communication. Not available for E1012 and E1022. A client asks for information and a server provides clients with information. The BDTP server listens to the I/O request from the BDTP client. The operator panel can be client, server, or both. The client can collect data from a maximum of 16 servers. The server IP addresses are specified in the BDTP client. Each server can provide 20 clients with information.

Network communication via BDTP is used to connect two or more E1000 operator panels to one or two controllers or several operator panels to two or more controllers, with retained performance. One example is production lines with one operator panel at each work station.

If the BDTP server fails, the client will continue to work with the system to which it is physically connected. The client will not restart when it tries to connect to the server. When the server becomes active, BDTP communication will continue as previously.

The command **BTIMx** can be used to adjust the BDTP reply timeout. Select **Setup/System Signals** and type **BTIMx** on the **Commands** line, where x represents number of seconds to wait for a response from a BDTP server/client before assuming the connection as lost. The minimum value is 1 second. The default value, i.e. when the command is not used, is 20 seconds.

The figure below shows an example of a network.

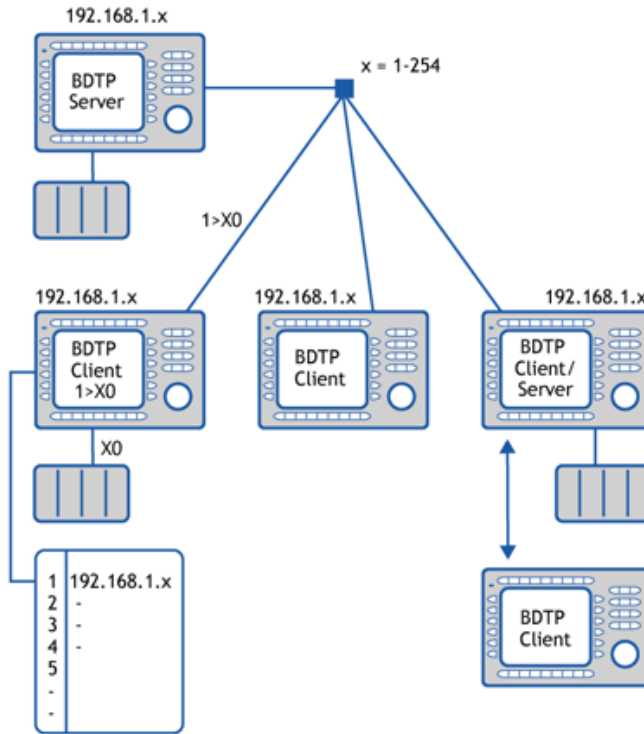

## BDTP Client

Not available for E1012 and E1022. For the network service BDTP Client, the IP Addresses for the BDTP Servers in the network from which the client is to collect information are defined. Select **BDTP Client** in the list and click **Edit** to enter the properties.

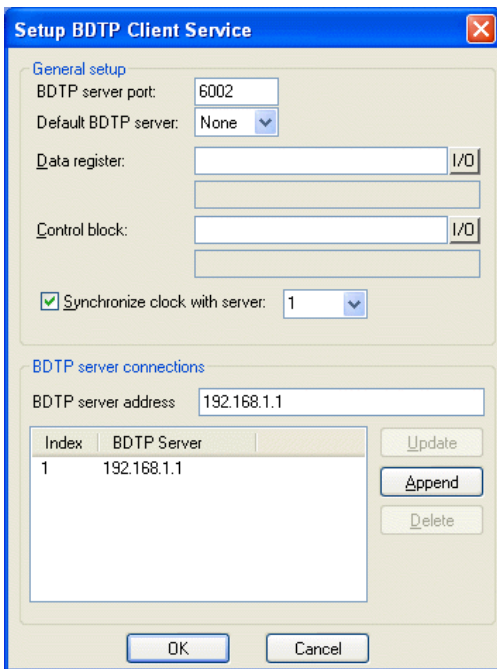

Setup/Network/Services  
Select BDTP Client and click Edit...

### BDTP server port

State the communication port the BDTP server/network is connected to. Does not normally need to be changed.

### Default BDTP server

A server can be specified as the default server, which means that if nothing else is specified when entering the I/O, signals are assumed to be collected from this server.

### Data register

Values in data registers can be transferred between a client and different servers in a network. The first register in the register block in the client which is to be transferred to/from the indicated server is stated under **Data register**. The type of register does not have to be the same in client and server.

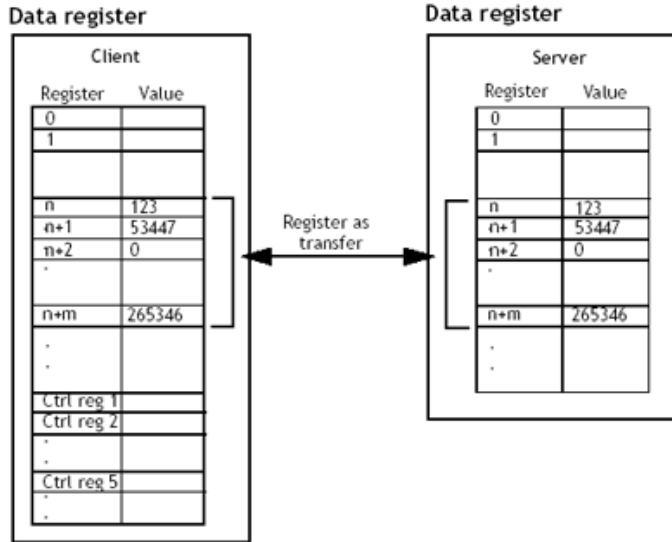

### Control block

Under **Control block** the first register in the control block in the client is stated. A total of five registers are used as follows.

Register	Content	Description
Ctrl reg 1	Command	Command register set in the client. Available commands: 0: No command. 1: Transfer values in register from client to server indicated in control register 3. 2: Transfer values in register from server indicated in control register 3 to client.
Ctrl reg 2	Handshake	Handshake register set by client. 0: Ready for new command. 1: OK 2: Transmission error.
Ctrl reg 3	Server index	The number of the server in the network the transfer is to be made with.
Ctrl reg 4	Index register	The value in the index register is added to the address of the register indicated under Data register. If zero is given, the register block will start with the address given under Data register.
Ctrl reg 5	Number of registers	The number of registers, the values of which are to be transferred to/from the given server.

The transfer must be handled as follows:

1. The handshake register must be 0. If not, reset the command register to 0.
2. Enter the command in the command register.
3. Wait for the ready signal or error code in the handshake register.
4. Set the command register 0. The operator panel will now set the handshake register to 0.

#### **Synchronize clock with server**

Indicate if the client clock is to be synchronized with a selected server (operator panel). The server is selected by giving the number of the server in the entry field. If the clock in the client is changed locally, the change will also be transferred to the selected server.

#### **BDTP server address**

Under **BDTP Server Address**, indicate the IP addresses to the servers from which the client will be able to retrieve data. The addresses will be indexed in the order they are entered.

When objects are programmed in the project you must indicate from which server the address is to be taken. In the address field in the object dialogs, you specify the following:

*server index>device*

If, for example, 2>D15 is indicated in the address field, the value for the object will be collected from register D15 in the server with index 2.

It is possible to change the server index in a client program with the function BDTP Station change. See the section [Changing BDTP Station](#).

---

#### **Note:**

If there is no controller connected to the BDTP Client (the operator panel,) the units **Controller 1** and **Controller 2** must be moved from RS-232C/RS-422/RS-485 to **Unused functions** in the Peripheral configuration dialog.

---

## BDTP Server

Handles requests from clients, i.e. provides clients (operator panels) with information on requests from the client (operator panel). Not available for E1012 and E1022. Select **BDTP Server** in the list and click **Edit** to enter the properties.

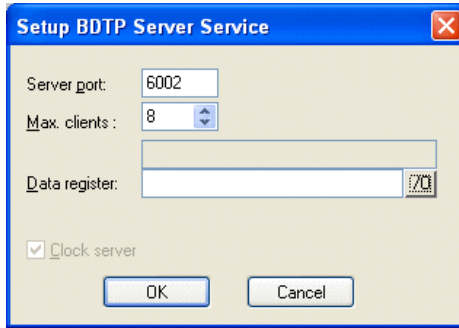

Setup/Network/Services  
Select BDTP Server and click Edit...

### Server port

Communication port for the BDTP server. Does not normally need to be changed.

### Max. clients

The maximum number of BDTP clients (operator panels) in the network.

### Data register

Values in data registers can be transferred between a server and different clients in a network. The first register in the register block in the server which is to be transferred to/from the indicated client is given under Data register. The type of register does not have to be the same in client and server. For more information on transferring data, see the section [BDTP Client](#).

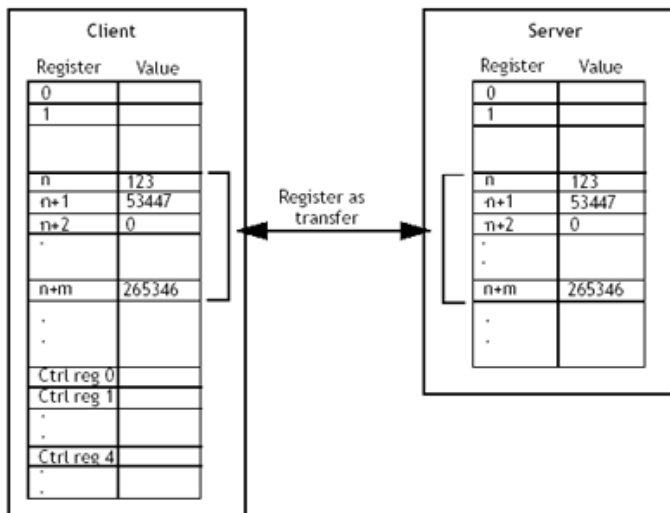

**Note:**

It is only possible to control the transfer of data from clients.

## FTP Server

This function makes it possible to collect or submit files to/from the operator panel from a PC. Not available for E1012 and E1022. The FTP server in the operator panel allows transfers in passive mode (PASV). Passive mode should be used if the operator panel is **not** connected Point-to-Point. You will not always know in advance what is used between the client and server, e.g. router-based fire walls or gateways. By using passive mode, further errors are avoided. Web browsers always use this mode. National characters in file names are not supported. Operator panels do not use dates on files. For more information on the FTP server in the operator panel, refer to the chapter *Network Functions in the Operator Panel*.



Select **FTP Server** and click **Edit** to enter properties.

Setup/Network/Services  
Select FTP Server and click Edit...

### Control port number

The default value is 21 and should not be changed.

### Data port number

The default value is 20 and should not be changed.

### Request login

You indicate here whether the user must login to access the FTP server (the operator panel). Users are defined under **Setup/Network/Accounts**, see the section [Network Accounts](#). If you select that users do not need to login, all users will have full access to the FTP server.

### Pre-login text

Text shown before request for the user to login. E.g. “The operator panel requires login, specify login information”.

### Post-login text

Text shown when user has logged in. E.g. “You are now logged in”.

### Connection timeout (min.)

The time the FTP connection is allowed to be inactive before the FTP server (the operator panel) breaks the connection. The default value is 10 minutes.

## Remote Access

This function makes it possible to access, reflect and control an operator panel from a PC by using the free VNC client program Remote Access Viewer together with the built-in VNC server in the operator panel. Not available for E1012 and E1022. For more information about Remote Access, refer to the documentation for Remote Access and Remote Access Viewer.

Only one VNC client can connect to the VNC server. To avoid that a connected client that has forgot to disconnect locks the connection, the **VNCDx** command can be used. Select **Setup/System Signals** and type **VNCDx** on the **Commands** line, where **x** represents a bit device. The current VNC session will be disconnected when the bit device **x** is set.

---

**Note:**

To protect secrecy when entering a password via Remote Access Viewer, it is recommended to use the PC keyboard. Otherwise it is possible that the cursor on the remote operator panel displays which keys are pressed on the alphanumeric keyboard.

---

## SMTP Client

This function allows e-mail to be sent from the operator panel. Not available for E1012 and E1022. An e-mail server is needed to use the function SMTP client, where messages are sent by the operator panel. The recipient then collects the message. You can use your Internet provider's e-mail server or a local e-mail server. Trend and recipe files can also be attached with a message. The attached files can be read with HMI Tools. A maximum of 20 messages can be sent at the same time. Select **SMTP client** under **Setup/Network/Services** and click **Edit...** The following properties are entered here.

**Setup SMTP Client Service**

Server port: 25

Mail server: 192.168.1.55

My domain name:

My e-mail address: mail@master.com

Authentication

Username:

Password:

Send via connection: TCP/IP connection 1

**Predefined recipients**

E-mail address: malin@work.com

In...	E-mail addresses
1	operator@theplant.com
2	karin@work.com
3	anders@work.com
4	tine@work.com
5	victoria@work.com
6	malin@work.com

Update

Append

Delete

OK Cancel

Setup/Network/Services  
Select SMTP client and click Edit...

### Server port

Connection port 25. Does not normally need to be changed.

### Mail server

The IP address to the e-mail server or the alias name (DNS server) for the SMTP e-mail server. If you specify an alias name, the IP address to the DNS server must be given under **Setup/Network/TCP/IP Connections**.

### Authentication

Used if the mail server demands SMTP Authentication (With SMTP Authentication, a user has to identify itself and, after a successful authentication, the reception of e-mails is granted.

Username: Username for the SMTP Authentication

Password: Password for the SMTP Authentication

### My e-mail address

Enter your e-mail address. The name is shown as sender for the recipient. It should preferably be a genuine address, to which the mail server can return error messages.

### Send via connection

Indicate which TCP/IP connection should be used to send.

### Predefined recipients

A pre-defined list of a maximum of 16 recipients, e-mail addresses which the operator panel is to send e-mail to. A recipient address can contain a maximum of 60 characters.

### Alarm Through E-mail

In the same way as alarms can be printed on a printer, they can also be sent as e-mail. The complete alarm list can be sent by sending block 990 (see the section [Report Through E-mail](#)). Each alarm can be connected to one or more of the e-mail addresses as in the configuration of the SMTP client. Under **Setup/Alarm Properties** you enter a general setting for which status of alarms are to be sent as e-mail. See the chapter [Alarm Management](#).

**Alarm Input \***

Alarm text: Motor 1 is overloaded 0/1  
A

Signal: D44 I/O Q3

**Alarm when**

Digital signal is:  On  Off

Analog signal is:  Equal to

Acknowledge notify:  I/O  Reset

Remote acknowledge:  I/O

Alarm group: DEFAULT

Info block:

Mail to address: operator@theplant.com

Ack. required  
 History  
 To printer  
 Repeat count

Functions/Alarms/New Alarm

### Info block

If an information block is indicated, and it is a text block, it will be included in the message. For further information, see the chapter [Alarm Management](#).

### Mail to address

You indicate here who is to receive the message. Select up to 8 recipients from the predefined list in the dialog **Setup SMTP Client service**.

### Report Through E-mail

In the same way as text blocks can be printed on a printer, they can also be sent as e-mail. Alarm block, block no. 990, can also be sent as e-mail.

---

#### Note:

Only text blocks can be sent. Only the alarm block 990 can be sent as e-mail from the system blocks. Trend and recipe files can be sent as attached files.

---

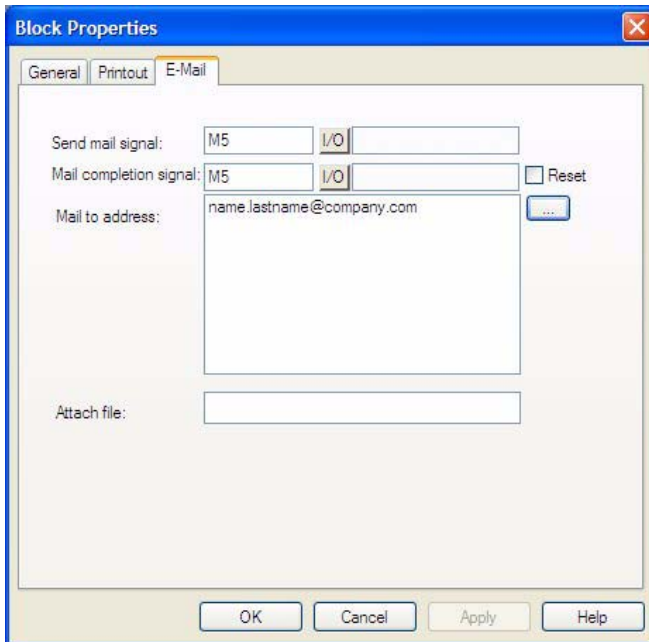

*Block Properties for a text block*

### Send mail signal

The message is sent when the given digital signal is set to one.

### Mail completion signal

A digital signal activated by the operator panel when the message has been sent. The signal is normally set to one by the operator panel. If the box Reset is selected, the signal is reset when the message has been sent.

### Mail to address

The address of the e-mail recipient is given here. Select up to 8 recipients from the list shown when you click the ... button. The list of e-mail addresses is defined in the dialog box **Setup SMTP Client** under **Setup/Network/Services**.

### Attach file

The name of a trend or recipe file to be attached with the message is given here. If there is a trend file or a recipe file with the same name, the trend file will be sent. The text file should not contain national characters such as Å, Ä and Ö.

## E-mail Through System Block

By making a block jump to the system block Mail, 993, you can write and send messages while the operator panel is running.

### Send E-mail to

Enter the recipient here. You can write in the address or select it from the global list shown when you click on the button LIST on operator panels with keyboards, and on the MAIL button on operator panels with touch screens.

### Subject

You enter the subject message here (maximum of 50 characters). The text in the message can be a maximum of 10 lines with 50 characters.

## Terminal Controller

Used for switching between run and transfer project mode through TCP/IP. Click **Edit** and enter the number of the port to be given to enable the transfer. The port number does not normally need to be changed. Check the box Request authentication if the user name and password must be given before the transfer. Users are defined under **Setup/Network/Accounts**.

## Transparent Mode

Used for communication in Transparent/Passthrough mode (see also the chapters *17 Communication* and *19 Network Functions in the Operator Panel*) in operator panel networks through Ethernet. Click **Edit Transparent mode**. The unit must then be connected to a **TCP/IP Connection** in **Setup/Peripherals**.

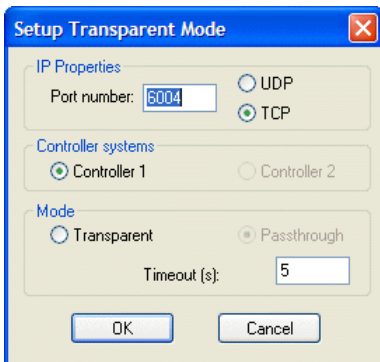

### IP Properties

Port number 6004. Does not normally need to be changed. Select required protocol, UDP or TCP.

### Controller systems

Select if Transparent/Passthrough mode is to be connected to **Controller 1** or **Controller 2**.

### Mode

Select communication mode Transparent or Passthrough. In the field **Timeout** the number of seconds is specified, after which the operator panel will return from the Passthrough status and start functioning normally again if no Passthrough communication has occurred.



## Web Server

This a function to configure the www server in the operator panel. Not available for E1012 and E1022. A web server is a program, which, by using the client/server model and Hypertext Transfer Protocol (HTTP) handles files building web pages for Internet users (who have computers which have HTTP clients). See the chapter *Network Functions in the Operator Panel*.



### Port number

The default setting is 80 and does not normally need to be changed.

### Account name

Selecting an account name protects the HTML pages in the operator panel with a password. The accounts are defined under **Setup/Network/Accounts**.

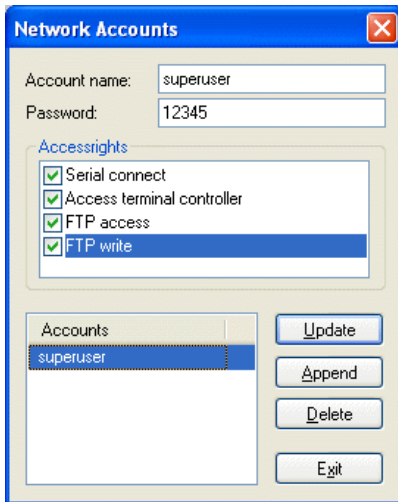

Setup/Network/Accounts

### Account name

The account name you entered in the previous dialog is shown here.

### **Password**

Enter a password. All HTML pages are protected with this Account name/Password.

The following are added to the HTML page header to protect a separate page with another Account name/Password.

```
<HTML>
  <HEAD>
    <META name="superuser" content="12345">*
  </HEAD>
```

The rest of the HTML code is placed here.

```
</HTML>
```

\* "superuser" is the account name and "12345" is the password.

---

#### **Note:**

The above must be used in the header. The parameters **Name** and **Content** must correspond to an account name and password.

---

## 18.5 Network Accounts

Under **Setup/Network/Accounts**, you define who is allowed to access the services in the operator panels which require login. The function is used to create an authorization check, i.e. you create a name and password for different users who are to have access to different services in the network. Account names and passwords must not contain national characters.

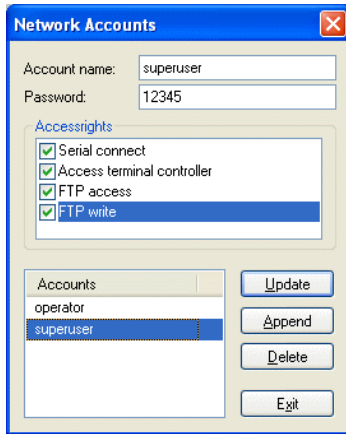

In accordance with the image, the account name Superuser is authorized for all network functions requiring login. You can update, add on, and remove accounts from the list with the buttons.

### Account name

Enter a name (user name) for the account.

### Password

Enter a password for the account.

### Accessrights

#### Serial connect

The user can use serial connection (PPP). Should be checked. Not available for E1012 and E1022.

#### Access terminal controller

The user can implement RUN/TRANSFER switching through TCP/IP. Should be checked.

#### FTP access

The user can read from the FTP server (the operator panel). Not available for E1012 and E1022.

#### FTP write

The user can write to the FTP server. Also requires FTP access. Not available for E1012 and E1022.

## 18.6 Recommendations and Limitations for Network Communication

To make the communication between operator panels and controllers in an operator panel network (BDTP network) quick and efficient, it is important to optimize the transfer of signals in the network. Read the chapter *Efficient Communication* and carefully follow the recommendations to optimize the network functionality in the operator panel. The maximum number of signals that can be transferred in an operator panel network is 3,000.

### Example 1

An operator panel network consists of three clients and one server. Each client has access to 1,000 signals, i.e. the server can handle (transfer to the different clients) 3,000 signals. This is also the case even if the address areas for the signals in the clients correspond. Accordingly, it is not possible to transfer more signals in the operator panel network.

### Example 2

The server's task is to collect together the addresses the clients are asking for. Thereafter the server asks for the status in the controller, which is then distributed to respective clients.

### Example

An operator panel network (BDTP network) consists of 1 server and 5 clients. Each operator panel contains 50 alarms with the same address. For the server, this means that 50 addresses must be checked with the controller, but the server will then also distribute 50 alarms to the respective client (5x50). The server therefore has 250 alarms to distribute.

## Transparent Mode through Ethernet

For the function **Transparent mode** (see the chapter *Communication*) to function with communication through Ethernet (the TCP/IP protocol,) the following requirements must be fulfilled.

- The driver and its configuration tool must support communication in Transparent mode. For information, see the manual for respective driver and controller.
- If the configuration tool for the controller does not support project transfer through TCP/IP, a PC program to convert the COM port to TCP/IP must be used in the PC to communicate with the controller in Transparent mode through the TCP/IP network.

## Passthrough Mode through Ethernet

With the program HMI Tools Connect (an icon in the program group HMI Tools) it is possible to activate/deactivate a communication port for communication in Passthrough mode (Transparent mode if this is supported by the drivers, see the chapter *Communication*). For the function Passthrough mode (see the chapter *Communication*) to function with communication through Ethernet (the TCP/IP protocol), the following requirements must be fulfilled.

- If the configuration tool for the controller does not support project transfer through TCP/IP, a PC program to convert the COM port to TCP/IP must be used in the PC which is to communicate with the controller in Transparent mode through the TCP/IP network.

For further information, please see the sections *Transparent Mode* and *Passthrough Mode*, the manual for HMI Tools and the manuals for the used drivers.

## No Protocol Mode

The function **No protocol mode**, when one or more operator panels are used as communication interface (see the chapter *Communication*), is not recommended in a large operator panel network (BDTP network). A large network refers to a BDTP network, where a large number of signals are transferred between server and clients. Control registers and control signals are transferred when the operator panel is used as a communication interface, and these influence the communication time and adversely affect the performance of the network. See the *Efficient Communication*.

## Packaging of Signals

To make the communication between operator panels and controllers quick and efficient, e.g. in a network, it is important to optimize the transfer of signals in the network. Read the chapter *Efficient Communication* and carefully follow the rules described there to optimize the network functionality in the operator panels. This applies to all stations in the operator panel network. If the packing of signals is not used, this may result in an increase in the updating times.

## Alarm Handling

The operator panel network is a client/server network. Servers provide data, e.g. alarm signals, to clients. A large number of different signals influence the communication time between operator panels and controllers in the network, which means that the number of these signals should be limited. For further information, see the chapter *Efficient Communication*. The number of alarm signals the network receives must not exceed the number the server can handle in the complete network. One server can handle up to 300 alarms, depending on the application and operator panel. This means that the network must not contain more than a total of 300 alarms.

## Index in Network Client

Index addressing, which makes it possible to select from which register an object is to collect the shown value, see the chapter *Index Addressing*, cannot be used in operator panels functioning as BDTP clients. BDTP clients only use the BDTP server's index register. If, however, an operator panel which is a BDTP client also has a local controller, normal handling of index addressing is applicable in accordance with the chapter *Index Addressing*.

## 18.7 Obtaining the MAC Address during Runtime

The unique hardware number of the operator panel, the MAC (Media Access Control) address, can be obtained during runtime by using a macro with the IPCONFIG command and the /ALL argument. Not available for E1012 and E1022.

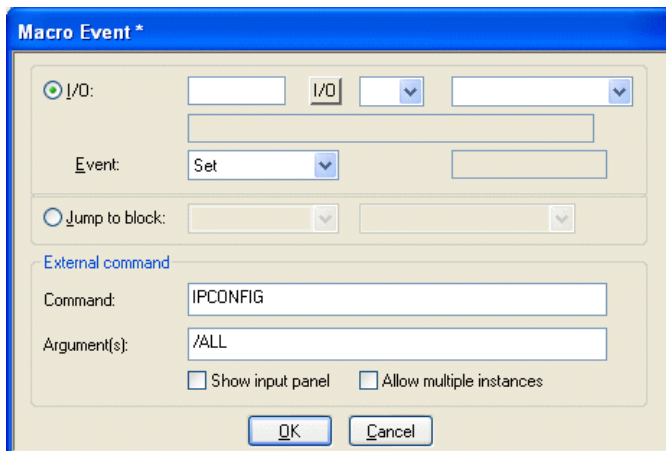

The IP configuration including the MAC address will then be displayed in a Windows CE Console.

Please see chapter *Macros* for further information about macros.

# 19 Network Functions in the Operator Panel

This chapter describes operation of the functions for the FTP server, SMTP client, operator panel applet and Web server function in the operator panel. Not available for E1012 and E1022. For further information about the different functions, please see the chapter *Network Communication*.

## 19.1 FTP Server

FTP (File Transport Protocol), a standard Internet protocol, is the easiest way of exchanging files between computers on the Internet. FTP is an application protocol which uses the Internet's TCP/IP protocols. FTP is normally used to transfer web pages from their creators to the server where everybody on the Internet can access them. It is also suitable for downloading programs and other files from another server (operator panel) to your own computer.

When the operator panel functions as an FTP server it is possible to upload/download files to/from the operator panel. To upload/download files, an FTP client program is required in the PC, e.g. HMI Tools, Internet Explorer, Windows Commander or some other standard FTP program.

Some libraries show files with a length of 0. This means that the file contains dynamic data, i.e. the size of the file changes. This also means that even if the length is 0 the file may not be empty. The operator panel does not use the date on the files, which means that the time shown is not relevant. The operator panel can save the contents in all files, which can be reached through FTP or accessed on an external memory card with different types of delimiter characters (separators). The contents of the files can be separated either with → [TAB] or the characters ; or .

The properties for FTP delimiter characters are made under **Setup/Terminal Options** in the configuration tool. The file name must not contain national characters. The operator panel's FTP server can handle a maximum of three connected clients at the same time.

---

**Note:**

Files in the different directories use up the project memory. The command PSCE can be used to include information about the available project memory in the file info.txt. Using the command in projects with a large number of trend curves will considerably slow down using FTP functions.

---

## Root Library

The root directory (current operator panel name) contains the following directories, ALARMS, HTML, RECIPES, TRENDS and IMAGES directory. See the section [The IMAGES Directory](#) for further information. Only the directories the user (account) has access to are shown. There is also a text file, info.txt, containing information about the operator panel.

### The File info.txt

The file info.txt contains information on the operator panel in accordance with the following example:

```
E1070
Firmware version: V1.00
Build number: 35
Driver1: Modbus Master 4.00.06
Driver2: DEMO 4.00.10
Dynamic memory:13107200 bytes free
Project memory: 1717867 bytes free
IP address:192.168.98.145
```

Nothing can be deleted from the root directory, not even by a user with write access. If the directories HTML or RECIPE are deleted, the contents of the directories will be deleted, but the directories will remain. The project memory information is displayed only if the PSCE command is used - see section [Commands](#).

## The ALARMS Directory

The directory is only shown if there is an alarm defined in the operator panel and the operator panel is running. The alarm groups are shown as .skv files with 0 length. This does not necessarily mean that there are no alarms. The files can only be read. To read a file it must be opened with the attribute READ. The attribute READ-WRITE will cause an error.

### File Format

Each alarm is stored on a line ending with [carriage return][linefeed].

The file contains the following information:

```
status;activedate;activetime;inactivedate;inactivetime;ackdate;acktime;alarmtext
```

All fields are always there. If the alarm is not acknowledged, the fields for date and time will be empty.

The file ends with END [carriage return][line feed].



## The HTML Directory

The data files handled by the web server are stored here. Subdirectories can be created. The start file (the HTML page shown as the first web page in the web browser) must always be called `index.html`.

By default, the operator panel's diagnostic page is set as `index.html`. If another start page is required, replace the `index.html` file.

### File Format

The file format depends on the type of file. A standardized file format such as HTML etc. is used here.

## The RECIPE Directory

The different recipes in recipe directories are shown as `.skv` files. It is possible to both read and write files in this directory.

### File Format

Each recipe value is stored on a line ending with [carriage return][linefeed].

The file contains the following information:

*device;value;datatype;length*

The file ends with END[carriage return][linefeed].

If the data type is array (AR), one value will be shown on each line. The first line will be shown as above. The following lines will only contain:

*;value*

## Data Types for Analog Signals

Type	Explanation	Type	Explanation
empty	Signed 16-bit	LB	BCD format 32-bit
+	Unsigned 16-bit	SH	Hexadecimal 16-bit
L	Signed 32-bit	LH	Hexadecimal 32-bit
L+	Unsigned 32-bit	RD	Float
RB	BCD format float	AR	Array of signed 16-bit
RF	Float with exponent	ST	String of characters
SB	BCD format 16-bit	BI	Bit 0 or 1

## The TRENDS Directory

The directory is only available if there are trends and/or data loggings defined in the operator panel and the operator panel is running. The trend objects are shown as .skv files with 0 length. It is only possible to read files. To read a file it must be opened with the attribute READ. The attribute READWRITE will cause an error. Curve 1 must be used for a trend to be valid.

### File Format

Each sampling is stored on a line ending with [carriage return][linefeed].

The file contains the following information:

*date;time;value1;value2;value3;value4;value5;value6;OFF*

The file ends with END[carriage return][linefeed].

Only the number of curves in the trend are transferred, i.e. no empty fields.

OFF is included in the sampling in the following cases, and indicates a pause in the sampling.

- When the operator panel enters run mode, a copy of the last stored sampling is added. The copy is marked with OFF. As soon as valid values reach the operator panel, new values are stored without OFF marking.
- When the Trend-enable signal is used, should the signal go low the sample is marked with OFF. When the signal goes high a new value is stored without OFF marking.
- When stored trend values are transferred through FTP, a sample with OFF marking will be stored. When the transfer is ready a new sample is stored without OFF marking.

## The IMAGES Directory

Images in the format BMP can be saved in the IMAGES directory. The bitmap images are presented in Static symbol objects in the operator panel when it is running. It is only possible to write, replace and delete files in this library. However, it is not possible to create sub-directories.

If you check the box **Use dynamic bitmaps** for a static symbol object, the operator panel will collect the specified bitmap file (name.bmp) from the directory IMAGES in the operator panel's file system. The bitmap image is presented on the operator panel's display when it is running.

The image to be presented must be transferred to the directory through FTP. It will then be possible through FTP to add, replace, or remove dynamic bitmap images on the operator panel's display by writing over, entering or deleting BMP files in the IMAGES directory.

The image for a dynamic bitmap image object is only shown in the operator panel when it is running. The bitmap images in the IMAGES directory are not shown (available) in the configuration tool.

---

**Note:**

Define the same X and Y size for the BMP image in the directory as for the symbol object defined in the configuration tool. It is not possible to read (collect) files from the IMAGES directory.

---

---

**Note:**

When transferring a BMP file to the IMAGES directory, the transfer will stop for a short moment when the operator panel converts the standard BMP format to the operator panel's own BMP format.

---

## The BACKUP Directory

Files can be uploaded and downloaded easily between the operator panel and an external memory card, by using the BACKUP directory.

When a Compact Flash memory card or USB Flash drive is connected to the operator panel, it is to be formatted as a backup card. The BACKUP directory contains the folders Projects, Recipes and Trends. It is only the contents of the BACKUP directory that is displayed when connecting to the operator panel via FTP.

Any kind of files, such as operator panel projects, trends, recipes, controller projects, manuals etc. can be saved in the BACKUP directory.

See also sections *Backup of Trend Data*, *Saving Individual Recipes on an External Memory Card in Runtime* and *Transfer to/from External Memory Card*.

## 19.2 SMTP Client

SMTP (Simple Mail Transfer Protocol) is a TCP/IP protocol used to send and receive e-mail. Since SMTP has limited functions to store received messages it is normally used together with one or two other protocols, POP3 or IMAP. These protocols allow the user to save messages in a server mailbox from where they can be collected later. This means that SMTP is normally used to send e-mail, and POP3 or IMAP to receive messages stored in the local server. The operator panel can function as an SMTP client, i.e. send e-mail. To use the SMTP client function it is necessary to have access to an e-mail server. You can use your Internet provider's e-mail server, or use a local e-mail server. See also the section *Network Services* in the chapter *Network Communication*.

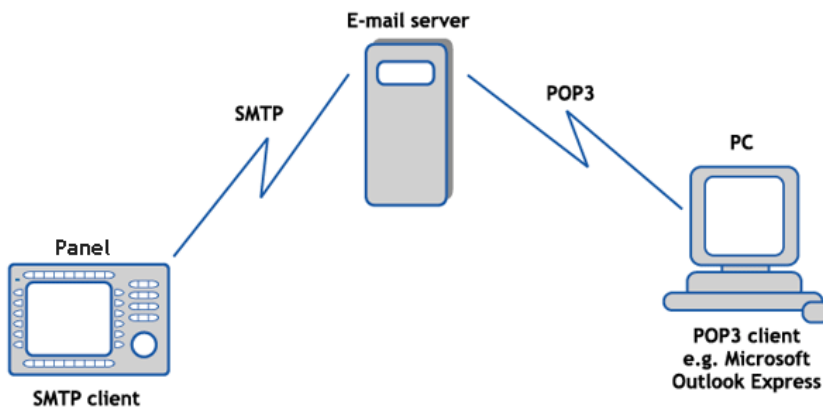

## 19.3 Web Server

A web server is a program which handles files that are to be displayed in a web browser, e.g. Internet Explorer. Each computer on the Internet containing a web page must have a web server program.

### SSI Script

An SSI (server-side include) is a variable value (e.g. a file) which a server can include in an HTML file before it is sent. If you create a web page you can add on a file in the HTML file as follows:

```
<!--#echo var="LAST_MODIFIED" -->
```

The following SSI scripts are supported in order to be able to show certain values from the operator panel in HTML pages.

Name	Parameters	Explanation	Example
get_ipaddr.fn	None	Shows the WWW server's IP address. Used in the CGI script.	<!--#exec cgi="get_ipaddr.fn"-->
get_domainname.fn	None	Shows the WWW server's domain name.	<!--#exec cgi="get_domainname.fn"-->
get_date.fn	Date format e.g. MM/DD/YY YY-MM-DD The operator panel properties are used if none are given.	Shows the date in the operator panel.	<!--#exec cgi="/get_date.fn MM/DD/YY"-->
get_time.fn	Time format, e.g. HH:MM:SS HH:MM The operator panel properties are used if none are given.	Shows the time in the operator panel.	<!--#exec cgi="/get_time.fn HH:MM"-->

Name	Parameters	Explanation	Example
get_device.fn	X, Y, Z X=device Y=presentation format (see separate table) Z=length	Shows the device value (a signal's value) from the controller.	<!--#exec cgi="/get_device.fn D5"--> <!--#exec cgi="/get_device.fn D5LH"--> <!--#exec cgi="/get_device.fn M7"--> <!--#exec cgi="/get_device.fn D9ST,30"--> <!--#exec cgi="/get_device.fn D0AR,10"-->
get_diag.fn	None	Shows the operator panel's diagnostic page.	<!--#exec cgi="/get_diag.fn"-->
get_mode.fn	None	Shows which operation mode the operator panel is in: RUN/PROG/SETUP/TRANSFER	<!--#exec cgi="/get_mode.fn"-->

Presentation format for **get\_device.fn**

Name	Length	Explanation	Example
None	None	Shows the value as signed 16-bit.	<!--#exec cgi="/get_device.fn D1"-->
+	None	Shows the value as unsigned 16-bit.	<!--#exec cgi="/get_device.fn D3+"-->
L	None	Shows the value as signed 32-bit.	<!--#exec cgi="/get_device.fn D7L"-->
L+	None	Shows the value as unsigned 32-bit.	<!--#exec cgi="/get_device.fn D2L+"-->
RB	None	Shows the value as 32-bit float BCD	<!--#exec cgi="/get_device.fn D10RB"-->
RF	None	Shows the value as 32-bit IEEE float	<!--#exec cgi="/get_device.fn D8RF"-->
RD	None	Shows the value as 32-bit IEEE float without exponent.	<!--#exec cgi="/get_device.fn D1RD"-->
SB	None	Shows the value as 16-bit BCD.	<!--#exec cgi="/get_device.fn D3SB"-->

Name	Length	Explanation	Example
LB	None	Shows the value as 32-bit BCD.	<!--#exec cgi=/get_device.fn D7LB"-->
SH	None	Shows the value as 16-bit HEX.	<!--#exec cgi=/get_device.fn D2SH"-->
LH	None	Shows the value as 32-bit HEX.	<!--#exec cgi=/get_device.fn D1LH"-->
AR	The number of values to be shown.	Shows the values as signed 16-bit.	<!--#exec cgi=/get_device.fn D5AR,10"-->
ST	Number of characters in the string.	Shows a number of registers as a string.	<!--#exec cgi="/get_device.fn D9ST,30"-->

**Note:**

In some cases the device and the presentation format has to be separated with a comma (.). When placing the cursor on the object, the tooltip displays information; see below.

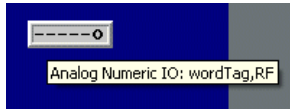

**Automatic Updating**

The HTML page is not normally updated automatically, but by adding the following code in the HTML page this creates automatic updating.

```
< meta http - equiv = " Refresh " CONTENT = " 5 " >
```

CONTENT indicates how often the page will be updated (in seconds).

## Example of HTML Page with SSI Script

```
< HTML >
  < HEAD>
    < meta http-equiv=" Refresh " CON-
TENT=" 5" >
  < / HEAD>
  <!-- # exec cgi="/ get_ipaddr. fn" --
>< BR >
  <!-- # exec cgi="/
get_domainname. fn" -->< BR >
  < BR >
  Some IO:< BR >
  <!-- # exec cgi="/ get_date. fn MM / DD /
YY" -->< BR >
  <!-- # exec cgi="/ get_time. fn HH:MM " -
->< BR >
  D5 = <!-- # exec cgi="/ get_device. fn
D5" -->< BR >
  M7 =<!-- # exec cgi="/ get_device. fn
M7 " -->< BR >
  D9 (string) = <!-- # exec cgi="/
get_device. fn D9 ST, 30 " -->< BR >
  D0 - D9 =<!-- # exec cgi="/
get_device. fn D0 AR, 10 " -->< BR >
  D8013 = <!-- # exec cgi="/
get_device. fn D8013" -->< BR >
< / HTML >
```



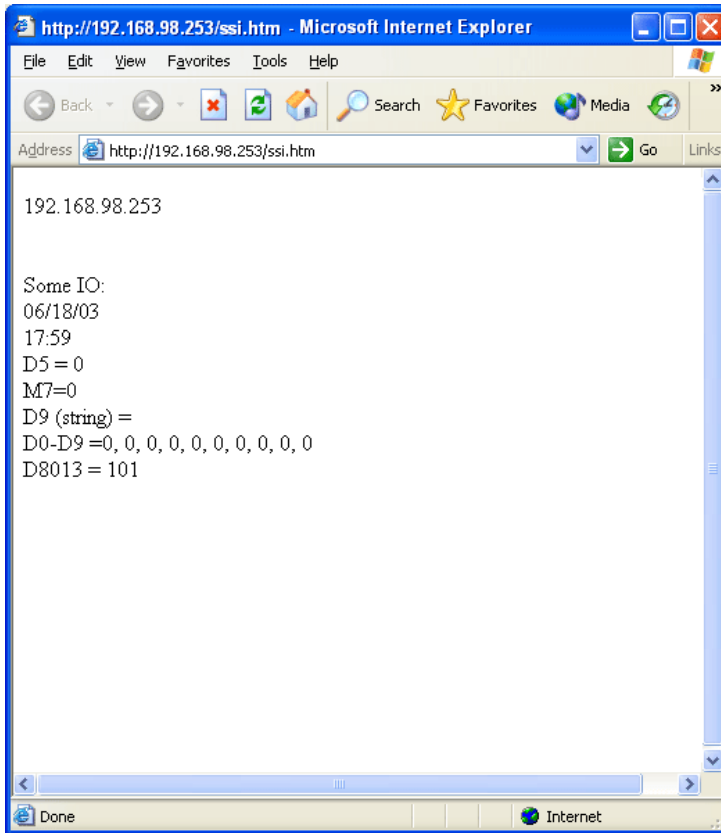

## CGI Script

CGI (Common Gateway Interface) is a standard method for a web server to handle data to and from the user. When the user requests a web page (by clicking on a link or entering the address in the web browser) the server sends back the required page. If you fill in a dialog on the web page and send it, it is normally received by an application program. The server sends a confirmation. The method of sending data between server and application is called CGI, and is part of the HTTP protocol.

The following CGI script is supported in order to change values in the operator pan-

el:

Name	Parameters	Explanation	Example
set_date.fn	Date format, e.g. MM/DD/YY YY-MM-DD The operator panel properties are used if none are given.	Used together with FORM to set the date in the operator panel.	<FORM ACTION="http://<!--#exec cgi="/get_ipaddr.fn"-->/set_date.fn" METHOD="POST"> <INPUT SIZE=10 MAXLENGTH=10 NAME="YY:MM:DD"> <INPUT TYPE="submit" VALUE="Submit"> </FORM>
set_time.fn	Time format, e.g. HH:MM:SS HH:MM The operator panel properties are used if none are given.	Used together with FORM to set the time in the operator panel.	<FORM ACTION="http://<!--#exec cgi="/get_ipaddr.fn"-->/set_time.fn" METHOD="POST"> <INPUT SIZE=10 MAXLENGTH=10 NAME="HH:MM:SS"> <INPUT TYPE="submit" VALUE="Submit"> </FORM>
set_device.fn	XY X = device Y = presentation format (see separate table) e.g. D0L+D5SH	Used together with FORM to set a device (a signal) in the controller.	<FORM ACTION="http://<!--#exec cgi="/get_ipaddr.fn"-->/set_device.fn" METHOD="POST"> <INPUT SIZE=10 MAXLENGTH=10 NAME="D0L"> <INPUT TYPE="submit" VALUE="Submit"> </FORM>

Name	Parameters	Explanation	Example
push_key.fn	(see separate table)	Used to simulate pressing a key in the operator panel.	<pre>&lt;FORM ACTION="http://&lt;!-- #exec cgi="/get_ipaddr.fn"--&gt;/ push_key.fn" METHOD="POST"&gt; &lt;SELECT NAME="F2"&gt; &lt;OPTION VALUE="SET"&gt;Set &lt;OPTION VALUE="RESET"&gt;Reset &lt;OPTION VALUE="TOGGLE"&gt;Tog- gle &lt;/SELECT&gt; &lt;INPUT TYPE="submit" VALUE="Submit"&gt; &lt;/FORM&gt; &lt;FORM ACTION="http://&lt;!-- #exec cgi="/get_ipaddr.fn"--&gt;/ push_key.fn" METHOD="POST"&gt; &lt;INPUT SIZE=1 MAXLENGTH=1 NAME="Key"&gt; &lt;INPUT TYPE="submit" VALUE="Submit"&gt; &lt;/FORM&gt;</pre>

Presentation format for **set\_device.fn**

Name	Explanation
None	Sets the value as signed 16-bit.
+	Sets the value as unsigned 16-bit.
L	Sets the value as signed 32-bit.
L+	Sets the value as unsigned 32-bit.
RB	Sets the value as 32-bit float BCD
RF	Sets the value as 32-bit IEEE float
RD	Sets the value as 32-bit IEEE float without exponent.
SB	Sets the value as 16-bit BCD.
LB	Sets the value as 32-bit BCD.
SH	Sets the value as 16-bit HEX.
LH	Sets the value as 32-bit HEX.
ST	Sets a number of registers as a string.

Parameters for **push\_key.fn**

Parameter	Explanation	Example
KEY	Can assume the values: A-Z 0-9 ACK LIST MAIN PREV BACKSPACE ENTER UP DOWN LEFT RIGHT	<pre>&lt;FORM ACTION="http://!-#exec cgi=/ get_ipaddr.fn"--&gt;/push_key.fn" METHOD="POST"&gt; Key = &lt;SELECT NAME="Key"&gt; &lt;OPTION VALUE="ENTER"&gt;Enter &lt;OPTION VALUE="A"&gt;A &lt;OPTION VALUE="B"&gt;B &lt;OPTION VALUE="1"&gt;1 &lt;OPTION VALUE="2"&gt;2 &lt;OPTION VALUE="3"&gt;3 &lt;OPTION VALUE="UP"&gt;Up &lt;OPTION VALUE="DOWN"&gt;Down &lt;OPTION VALUE="LEFT"&gt;Left &lt;OPTION VALUE="RIGHT"&gt;Right &lt;OPTION VALUE="PREV"&gt;Prev &lt;/SELECT&gt; &lt;INPUT TYPE="submit" VALUE="Submit"&gt; &lt;P&gt; &lt;/FORM&gt;</pre>
F1-F22	Can assume the values: SET RESET TOGGLE	<pre>&lt;FORM ACTION="http://!-#exec cgi=/ get_ipaddr.fn"--&gt;/push_key.fn" METHOD="POST"&gt; &lt;SELECT NAME="F2"&gt; &lt;OPTION VALUE="SET"&gt;Set &lt;OPTION VALUE="RESET"&gt;Reset &lt;OPTION VALUE="TOGGLE"&gt;Toggle &lt;/SELECT&gt; &lt;INPUT TYPE="submit" VALUE="Submit"&gt; &lt;/FORM&gt;</pre>

**Example of HTML Page with SSI and CGI Script:**

```

<HTML>
    <FORM ACTION="http://<!--#exec
cgi="/get_ipaddr.fn"-->/
    set_date.fn" METHOD="POST">
    Set date here (YY:MM:DD):
    <INPUT SIZE=10
        MAXLENGTH=10
        NAME="YY:MM:DD"
        VALUE="<!--#exec cgi="/
get_date.fn"-->">
    <INPUT TYPE="submit" VALUE="Submit">
<P>
    </FORM>
    <FORM ACTION="http://<!--#exec
cgi="/get_ipaddr.fn"-->/
    set_time.fn" METHOD="POST">
    Set time here (HH:MM:SS):
    <INPUT SIZE=10
        MAXLENGTH=10
        NAME="HH:MM:SS"
        VALUE="<!--#exec cgi="/
get_time.fn"-->">
    <INPUT TYPE="submit" VALUE="Submit">
<P>
    </FORM>
    <FORM ACTION="http://<!--#exec
cgi="/get_ipaddr.fn"-->/
    set_device.fn" METHOD="POST">
    D0 =
    <INPUT SIZE=10
        MAXLENGTH=10
        NAME="D0"
        VALUE="<!--#exec cgi="/
get_device.fn D0"-->">
    <INPUT TYPE="submit" VALUE="Submit">
    </FORM>
</HTML>

```

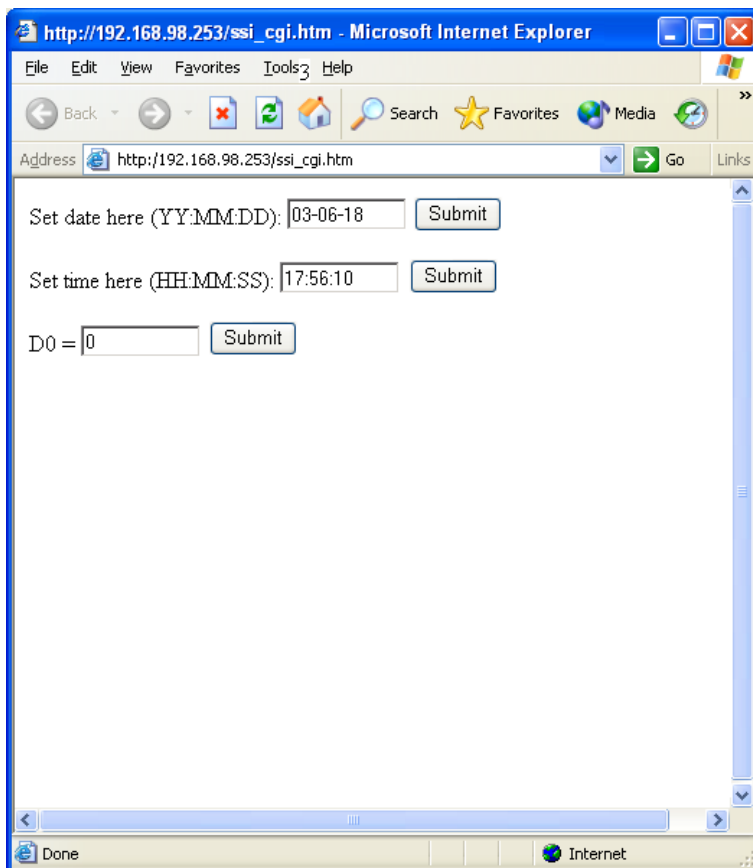

## Save HTML Files with FTP

To transfer HTML files to the operator panel, a standard FTP client program is used (See the section [FTP Server](#)).

The files transferred to the HTML directory in the operator panel's file system.

The name of the files should be in DOS 8.3 format, i.e. a maximum of 8 characters and the extension htm.

---

### Note:

The file INDEX.HTML must always be used (must be available in the operator panel).

---

## 20 LEDs

This chapter is applicable for operator panels with LEDs.

The operator panels have built-in LEDs, connected to a register defined by double-clicking **LEDs** in the Project Manager. The contents of the register determine the color and blinking frequency of the LEDs according to the following table.

Register value (Hex)	Register value (Dec)	Blinking frequency (Hz)	Color
00	0	-	None
01	1	-	Green
02	2	-	Red
11	17	5	Green
12	18	5	Red
21	33	2.5	Green
22	34	2.5	Red
31	49	1.2	Green
32	50	1.2	Red
41	65	0.6	Green
42	66	0.6	Red





## 21 Function Keys

This chapter describes how function keys are used, and how to convert the arrow keys on the operator panel to function keys.

A function key can be configured to control and change the values of devices in the controller. The function key can also be assigned to switch block, start a macro or other functions like load recipe, login and log out.

---

**Note:**

It is only possible to activate two signals connected to function keys at the same time. This means that if more than two function keys are pressed at the same time, only the first two will be activated.

---



The operator panels have a different number of built-in function keys, depending on the operator panel model. Start numbering the function keys on the left hand side (from the top downwards), continue with the keys on the right hand side and finally use the function keys at the bottom (from left to right).

---

**Note:**

The function keys will be disabled if the backlight of the panel is disabled.

---

## 21.1 Definitions

There are two ways of defining function keys; *globally* and *locally*. Global function keys are defined and used in the complete application, i.e. they are valid in all blocks. Local function keys are defined and used in one block. A global definition can always be accessed when the operator panel is running, provided that the current block does not have any local definitions for that function key. Local definitions have higher priority than global definitions. Global definitions are defined by double-clicking **Function keys** in the Project Manager. Local function keys are defined under the **Local function keys** tab in the block properties dialog for the current block.

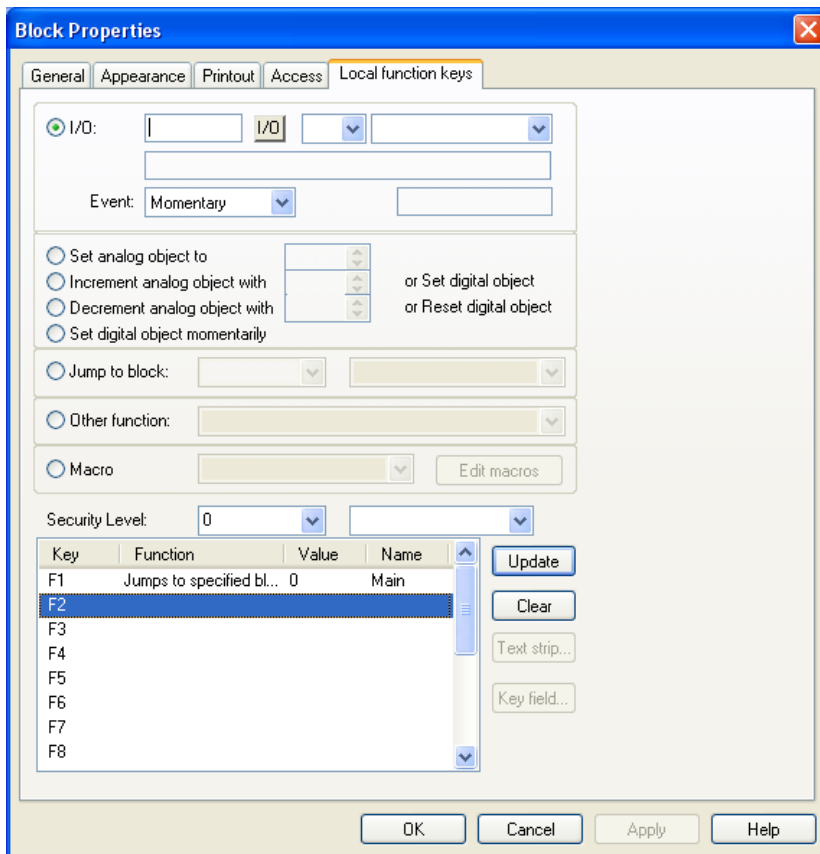

Function	Description
I/O	The signal activated by the function key. The subsequent field is used to specify an index register and signal format. See the chapters <a href="#">Index Addressing</a> and <a href="#">Signal Format</a> .
Event	By selecting Event it is possible for the key to influence the given signal according to the following alternatives: <b>Momentary</b> means that the signal is set to one as long as the key is pressed. <b>Toggle</b> means that the signal is set to one or reset alternately when the key is activated. <b>Set</b> means that the signal is set when the key is activated, and remains set. <b>Reset</b> means that the signal is reset when the key is activated, and remains reset. <b>Grouped</b> means that all signals belonging to a function key with the relevant group number are reset. The group number is stated in the <b>Group</b> field. A maximum of 8 function keys can be included in a group. <b>Sets analog</b> means that the analog signal linked to the function key is allocated the value given in the field <b>Value</b> . <b>Increments analog</b> means that the analog signal linked to the function key will increase the value by the value given in the <b>Value</b> field. <b>Decrements analog</b> means that the analog signal linked to the function key will decrease the value by the value given in the <b>Value</b> field.
Set analog object to	Allocates maneuverable analog object selected with the cursor for the specified value.
Increment analog object with or Set digital object	Increases the value for the selected maneuverable analog object with the specified value or sets the selected maneuverable digital object.
Decrement analog object with or Reset digital object	Decreases the value for the selected maneuverable analog object with the entered value or resets the selected maneuverable digital object.
Set digital object momentarily	Sets the selected digital object to one as long as the key is pressed.
Jump to block	Jumps to block with the specified name/number.
Other function	The function or touch key is linked to one of the functions in the list of options according to the table <a href="#">Other Functions for Function and Touch Keys</a> .

Function	Description
Macro	The selected macro is run. See the chapter <a href="#">Macros</a> . With the button <b>Edit macro</b> the name of the selected macro or the macro event for the selected event can be changed.
Security Level	Function keys can be defined with a security level, which means that the operator must log in with a password for the same or higher security level to be able to use the function key.

## Other Functions for Function and Touch Keys

Function	Description
Load recipe	Collects recipe from the memory in the operator panel.
Save recipe	Saves recipe to the memory in the operator panel.
Delete recipe	Deletes recipe from the memory in the operator panel.
Append recipe	Adds signals and their values from the current block to an existing recipe. See the chapter <a href="#">Recipes</a> .
Login to specified security level	Login. See the chapter <a href="#">Passwords</a> .
Logout	Logout.
Change login password	Changes password.
Scroll one page up	Scrolls the page in alarm list.
Scroll one page down	Scrolls the page in alarm list.
Increase text size	Increases the text size in the alarm list.
Decrease text size	Reduces the text size in the alarm list.
Save recipe to memory card*	Saves recipe to a memory card defined for backup.
Load recipe from memory card*	Collects recipe from a memory card defined for backup.
Erase recipe on memory card*	Deletes recipe from a memory card defined for backup.
Save project to memory card*	Saves project to a memory card defined for backup. The project can then be transferred to another panel.
Load project from memory card*	Collects project from a memory card defined for backup.
Erase project on memory card*	Deletes project from a memory card defined for backup.
Acknowledge alarm	Acknowledges alarm in the alarm list.
Show alarm list	Shows the alarm list (block 990).

Function	Description
Jump to info block connected to the alarm	Jumps to a block linked to the alarm. Applies to the selected alarm line or in the alarm list. See the chapter <a href="#">Alarm Management</a> for further information.
List alarm groups	Selects from which alarm group the alarm should be shown in the alarm list.
Saves alarm list to memory card	Copies the alarms in the operator panel to a USB memory stick. See the chapter <a href="#">Alarm Backup</a> for further information.
Return to previous block	Shows “previous block” functions in nine levels backwards. When block 0 is shown it is not possible to jump to the previous block with this function. Block jumps cannot be made with this function if logon is made at a higher security level than the current level.
Jump to main block (block 0)	Shows the start block, block number 0.
Shows object info	Used in the alarm block to display detailed information about alarms. See the chapter <a href="#">Alarm Management</a> for further information.
Enter	Corresponds to pressing the Enter key.
Show diagnostic page	Shows the diagnostic page for the operator panel. See section <a href="#">Diagnostic Page</a> for further information.
TCP/IP Connect*	Initiates connection during serial TCP/IP connection.
TCP/IP Disconnect*	Disconnects serial TCP/IP connection.

\* Not available for E1012 and E1022.

## 21.2 Jump to Block with Function Keys

This function makes it possible to use function keys to jump to blocks without having to use a **Display signal**. Select **Jump to block** from the list when a local or global key is defined.

Changing blocks using function keys is the quickest way of changing blocks, and does not occupy digital signals in the controller.

## 21.3 Joystick Function

Only applicable for key pad models.

The joystick function makes it possible to use the arrow keys as function keys. Double-click on **System Signals** under the **Setup** folder in the Project Manager, and type the command AK and an address on the command line, for example, AKM10 (command AK and memory cell M10).

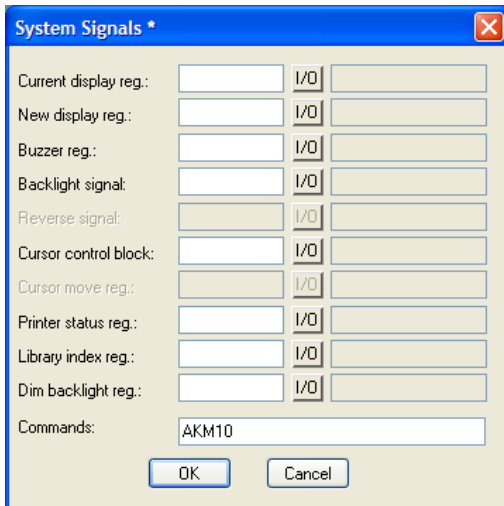

Memory cell M10 is the enable signal, and the following four memory cells have functions according to the following control blocks.

Memory cell	Description
Mn0	Activated. The arrow keys are deactivated. Deactivated = normal function.
Mn1	Left arrow
Mn2	Down arrow
Mn3	Up arrow
Mn4	Right arrow

If an arrow key is pressed when the enable signal is on, the memory cell corresponding to that key will be set to one. When the enable signal is set to one the arrow keys will not have their normal functions.

## 21.4 Extended Function Keyboard

The extended function keyboard X-Key 16 can be used to provide an E1000 operator panel with 16 extended function keys and LEDs. Not available for E1012 and E1022. A maximum of four extended keyboards can be connected to one operator panel. The panel scans all keyboards in the network, detects changes on function keys and writes new values to the LED register. Please see the manual MA00941A for further information.

For the E-series operator panels, the expansion keyboard E-Key 16 is available. Please see the manual MA00644A for further information.





## 22 Macros

This chapter describes how macros are used to link several events in the operator panel together to one single command. If you often perform the same commands and properties in the operator panel you can use macros to automate these maneuvers, i.e. create a macro for them. A macro is activated from local and/or global function and touch keys, or by activating an I/O. Macros are defined by double-clicking **Macros** in the Project Manager.

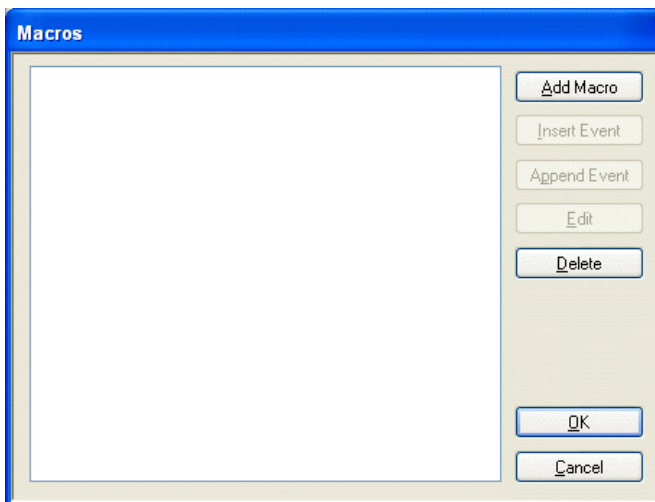

### Add Macro

Click **Add Macro** to display the following dialog. There is no limitation to the number of macros that can be defined.

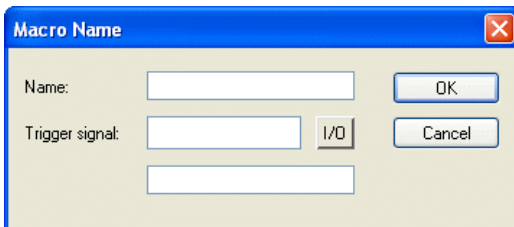

Specify an arbitrary name for the macro; the name must be unique. Click **OK** if the macro is to be triggered by a function or touch key. To trigger the macro by activating an I/O, state a signal in the **Trigger signal** field. If the I/O is given a name using *The Name List* function, this name is also displayed. Then click **OK**. Selection of trigger signal is not available for E1012 and E1022.

The macro is shown in the list with the specified name.

## Insert Event or Append Event

Click **Insert Event** or **Append Event** to display the following dialog. Each macro can contain a maximum of eight different events (lines).

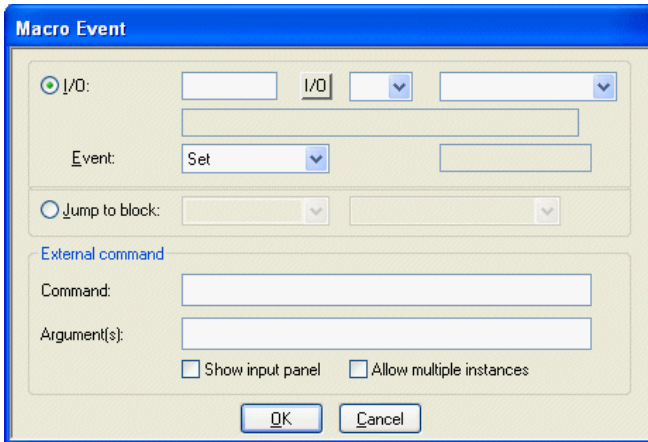

Parameter	Description
I/O	<p>The signal to be linked to an event in the macro. In the field <b>Event</b>, select which of the following events to be linked to the signal in the macro:</p> <p><b>Set</b> - means that the digital signal is set to one and remains set to one when the macro is activated from a key.</p> <p><b>Dec analog</b> - means that the analog signal will decrease the value by the value indicated in the field <b>Value</b> when the macro is activated from a key.</p> <p><b>Reset</b> - means that the digital signal is reset and remains reset when the macro is activated from a key.</p> <p><b>Set Analog</b> - means that the analog signal is given the value by the value indicated in the field <b>Value</b> when the macro is activated from a key.</p> <p><b>Toggle</b> - means that the digital signal is set to one and reset alternately when the macro is activated from a key.</p> <p><b>Inc analog</b> - means that the analog signal will increase the value by the value indicated in the field <b>Value</b> when the macro is activated from a key.</p>
Jump to block	<p>Indicate the number of the name of the block to which a block jump is to be made when the macro is activated from a key. A block jump can only be the last event in a macro, since a block jump ends the macro.</p>

Parameter	Description
Command*	The command that should be activated: <b>IPCONFIG</b> Collects and shows current IP Address for the panel. <b>PING</b> Checks if a host is available. <b>ROUTE</b> Shows/adds/deletes routes
Argument*	Text field that give the argument for the command i.e. 192.168.1.1 for the command PING.
Show input panel*	Yes/No (only touch) if an input panel should be displayed while the program is running.
Allow multiple instances*	Yes/No if it is possible to run multiple instances of the program at the same time.

\* Not available for E1012 and E1022.

## Edit

Click **Edit** to change the name of the selected macro or change the macro event for the selected event, or double-click on the macro or macro event to edit.

## Activate a Macro from a Trigger Signal

To activate a macro by a trigger signal (an I/O), the signal is entered in the **Trigger signal** field in the dialog displayed by clicking **Add macro** in the **Macros** dialog. Digital or analog signals can be used as trigger signals. Not available for E1012 and E1022.

## Activate a Macro from a Function or Touch Key

Macros can be activated from function or touch keys. Each key (global or local) can be linked to a macro. The desired macro for the key is selected in the dialog for local and global function and touch keys.

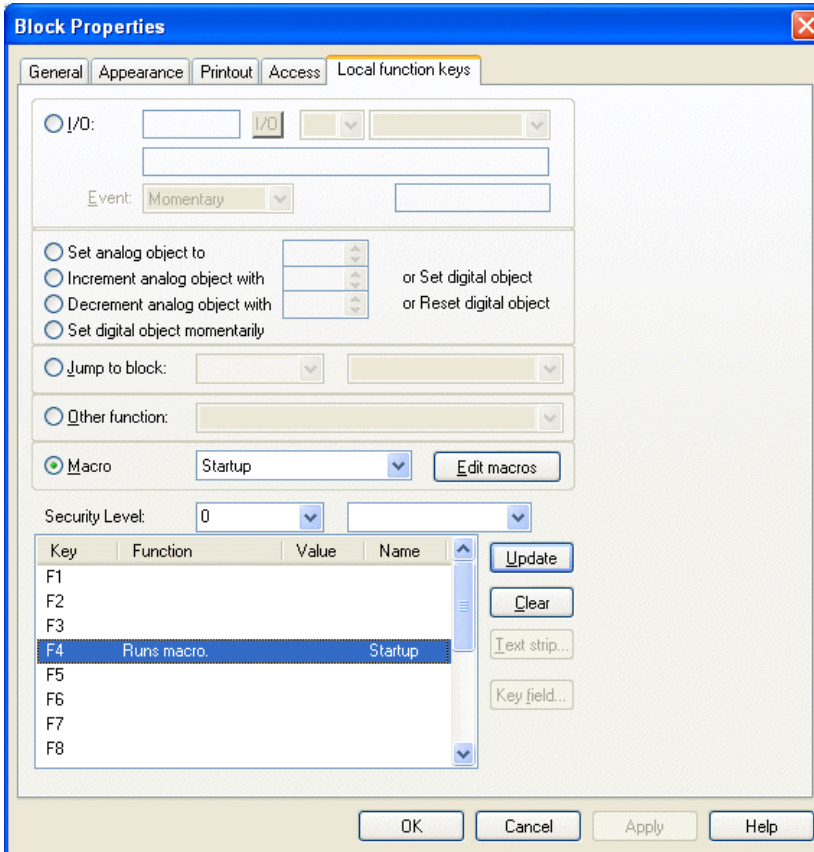

## 23 Project Transfer

To use a project in the operator panel, it has to be transferred from the PC where it is created to the operator panel.

Connect the PC with the configuration tool to the operator panel.

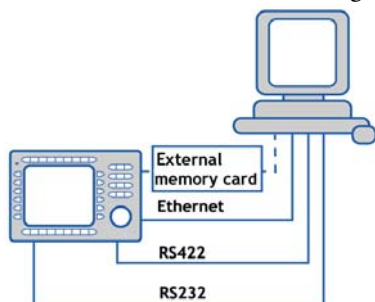

### 23.1 Transfer Properties

The transfer of projects is controlled from the configuration tool. In the configuration tool under **Transfer/Project** you can select what is to be transferred.

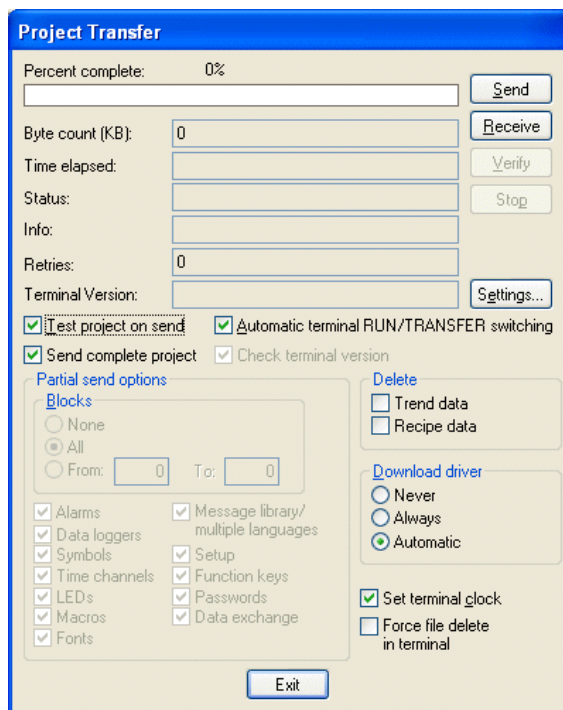

Parameter	Description
Percent complete	Shows how much of the project has been transferred during the transfer.
Byte count (kb)	Shows how many kilobytes have been transferred during the transfer.
Time elapsed	Shows how much time has elapsed since the functions Send, Receive or Verify were activated.
Status	Shows the transfer status and which part of the project is being transferred. E.g. properties, individual blocks, alarm groups, individual symbols and function keys.
Info	Shows the defined driver to be transferred to the operator panel.
Retries	In the event of transfer problems, the configuration tool makes a number of retries before the transfer shuts down.
Terminal Version	When contact has been established with the operator panel, the current operator panel type and its system program version number are shown.
Test project on send	Automatically tests the project before transfer.
Automatic terminal RUN/TRANSFER switching	The operator panel is automatically set in transfer mode and returns after transfer to the mode the operator panel was in before the transfer.
Check terminal version	Compares the system program version in the operator panel with the installed version for the project in the configuration tool.
Send complete project	Select whether the complete project is to be transferred.
Partial send options	<p>Block</p> <p>None: No blocks to be sent to operator panel.</p> <p>All: All blocks to be sent to operator panel.</p> <p>From To: Specify an interval of blocks to be sent to the operator panel.</p> <p>Alarms: Select if alarms are to be sent to the operator panel.</p> <p>Data Loggers: Select if data loggers are to be sent to the operator panel.</p> <p>Symbols: Select if symbols are to be sent to the operator panel.</p> <p>Time channels: Select if time channels are to be sent to the operator panel.</p> <p>LEDs: Select if LEDs are to be sent to the operator panel.</p> <p>Macros: Select if macros are to be sent to the operator panel.</p> <p>Fonts*: Select if fonts are to be sent to the operator panel.</p> <p>Message library: Select if message library is to be sent to the operator panel.</p> <p>Setup: Select if configurations under Properties are to be sent to the operator panel.</p> <p>Function keys: Select if function keys are to be sent to the operator panel.</p> <p>Passwords: Select if passwords are to be sent to the operator panel.</p> <p>Data exchange: Select if data transfer is to be sent to the operator panel.</p>

Parameter	Description
Delete	Trend data**: All stored trend/data logger data in the operator panel is deleted. Recipe data: All stored recipe data in the operator panel is deleted.
Download driver	Never: Driver never downloaded. Always: Driver always downloaded. Automatic: Driver will be downloaded to the operator panel when the driver in operator panel and the defined driver in the current project are not the same, or the same version.
Set terminal clock	The clock in the PC is transferred to the operator panel.
Force file delete in terminal**	All the files will be deleted in the panel and replaced by the new, i.e. the file structure in the panel will be remade.
Send	Transfer the project to the operator panel with the current properties.
Receive	The configuration tool imports the project from the operator panel. The current project in the configuration tool is overwritten. There must be an active project in the configuration tool if you are to upload a project from the operator panel.
Stop	Interrupts the transfer in progress.
Settings	Setup of communication parameters.

\* Note that some fonts, especially some Asian fonts, use a lot of the project memory.

\*\* Not available for E1012 and E1022.

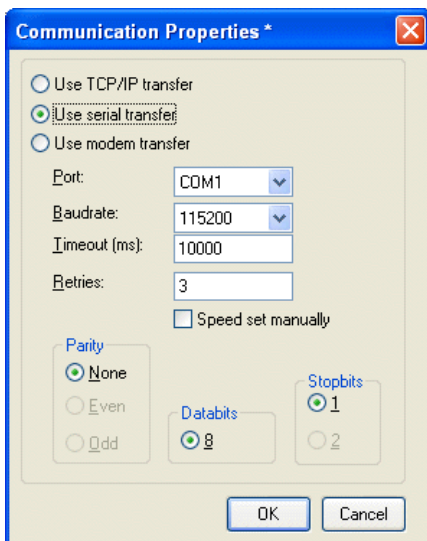

The communication parameters are set under **Transfer/Communication Properties** or by selecting **Settings** in the dialog **Project Transfer**.

Parameter	Description
Use TCP/IP transfer	Select if the project is to be transferred through TCP/IP. See the section <a href="#">TCP/IP Transfer</a> .
Use serial transfer	Select if serial transfer of the project is to be used. See the section <a href="#">Serial Transfer</a> .
Use modem transfer	Select if modem transfer of the project is to be used. See the section <a href="#">Modem Transfer</a> .
Port	Select communication port for the PC.
Baudrate	Transfer speed (bits/second).
Timeout (ms)	Indicate the number of milliseconds between retries.
Retries	Indicate the number of retries before the transfer shuts down.
Speed set manually	Only used for older operator panel versions during modem communication. The transfer speed must then be set manually in the operator panel and in the configuration tool, they must be the same. The operator panel must also be manually set in transfer mode.
Parity	Select type of parity control.
Databits	Number of databits for the transfer. Must be 8 bits.
Stopbits	Select the number of stopbits for the transfer.



**Note:**

Running other Windows programs at the same time as a project is transferred can lead to communication errors. This is avoided by closing other programs. Links to signals will be included when transferring blocks.

## 23.2 TCP/IP Transfer

When transferring through TCP/IP, you must select **Use TCP/IP transfer** under **Transfer/Communication Properties**. When you click **Send** in the dialog **Project Transfer** the following dialog is shown.

### Host address

Indicate the IP address of the operator panel you want to transfer to.

### Terminal control port

Specify the TCP/IP port number for RUN/TRANSFER switching. Does not normally need to be changed. The default setting is 6001.

### Transfer port

Specify the TCP/IP port number for the transfer (project transfer server). Does not normally need to be changed. The default setting is 6000.

### User ID

Specify a user name to be used to verify RUN/TRANSFER switching. Not used if the operator panel is already in transfer mode.

### Password

Specify a password to be used to verify RUN/TRANSFER switching. Not used if the operator panel is already in transfer mode.

### Save password in project

Saves the password and user name so that you will not need to give them next time.

## 23.3 Serial Transfer

For serial transfer, you select **Use serial transfer** under **Transfer/Communication Properties**. When you click **Send** in the dialog **Project Transfer**, the project will be transferred to the operator panel.

## 23.4 Modem Transfer

To transfer by modem, you select **Use modem transfer** under **Transfer/Communication Properties**. When you click **Send** in the dialog **Project Transfer**, the project will be transferred to the operator panel.

### Modem Properties

The properties on the modem connected to the operator panel should be set as follows:

```
AT &F &D0 &K0 &C1 E0 Q0 V1 S0=1 &W
```

The properties on the modem connected to the PC should be set as follows:

```
AT &F &D0 &K0 &C1 E0 Q0 V1 S0=1 &W
```

For more information regarding the modem string, refer to the manual for the modem.

### Communication Properties

1. Configure the modem.
2. Set the communication properties under **Transfer/Communication Properties** in the configuration tool. Select **Use modem transfer**.

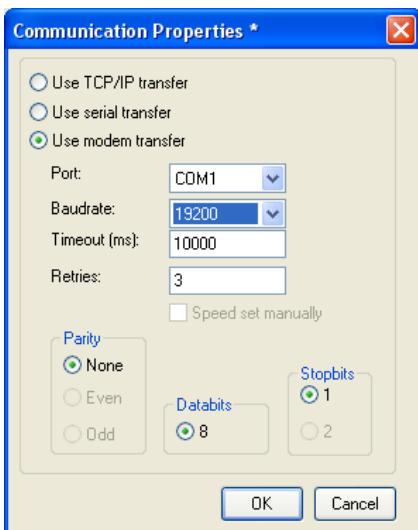

3. Select port and set the transfer speed (baud rate), parity and stop bits.
4. Use the program HMI Tools Connect to dial up.
5. Select **Send** in the configuration tool.

**Project Transfer**

Percent complete: 0%

Byte count (KB): 0

Time elapsed:

Status:

Info:

Retries: 0

Terminal Version:

Test project on send     Automatic terminal RUN/TRANSFER switching

Send complete project     Check terminal version

**Partial send options**

**Blocks**

None

All

From: 0 To: 0

Alarms     Message library/  
multiple languages

Data loggers     Setup

Symbols     Function keys

Time channels     Passwords

LEDs     Data exchange

Macros

Fonts

**Delete**

Trend data

Recipe data

**Download driver**

Never

Always

Automatic

Set terminal glock

Force file delete  
in terminal

## Transfer via GSM Modem

A special procedure is required when transferring via GSM modem. The operator panel has to be set in transfer mode and run mode manually.

1. In E-Designer, select the communication properties for modem transfer as described in the previous section.
2. Enter the Service Menu in the operator panel by setting the mode switches on the back of the operator panel in mode 1000. Please see the Hardware and Installation manual for the operator panel for information about the mode switches.

---

**Note:**

The Service Menu is also displayed (without changing the mode switches) when turning on the power to an empty operator panel.

---

3. Select **Enter Transfer Mode** in the Service Menu.
4. Turn the power off from the operator panel, reset the mode switches to mode 0000, and then turn the power on again. The operator panel is now started in transfer mode.
5. Download the project to the operator panel by clicking **Send** in the Project Transfer dialog in E-Designer.
6. Enter the Service Menu once again by setting the mode switches in mode 1000.
7. Select **Enter Run Mode** in the Service Menu.
8. Turn the power off from the operator panel, reset the mode switches to mode 0000, and then turn the power on again. The operator panel is now started in run mode.

The operator panel is now running the downloaded project.

## 23.5 Transfer to/from External Memory Card

Not available for E1012 and E1022.

### Export Project to Memory Card

In order to export the project to a Compact Flash memory card or USB Flash drive, select **Transfer/Export Project Transfer File**. The output from the export is a dat-file.

---

**Note:**

Use of Compact Flash cards is not supported in the E1012, E1022, E1032, E1041, E1043, E1060, E1061, E1062 and E1063 operator panels.

---

### Load Project from Memory Card

Save the dat-file to the library BACKUP/PROJECTS on the external memory card. The file structure is automatically created when formatting the card in the operator panel. If no operator panel is available, the library structure must be created manually.

A function or touch key can be configured in the configuration tool to download the operator panel project, by selecting the function *Loads project from memory card*. See also chapter *Function Keys*.

The command **MCI** can be used to indicate that a memory card is used in the panel. Type **MCIx** on the Commands line by selecting **Setup/System Signals**. **x** represents the digital signal that will be set when a memory card is inserted.

## Load Project Automatically on Detection

Save the project file to the root of the external memory card. Only one project is supported in the root for automatic detection and loading of project.

Settings for loading the project to the operator panel are made by selecting **Setup/ Terminal Options**.

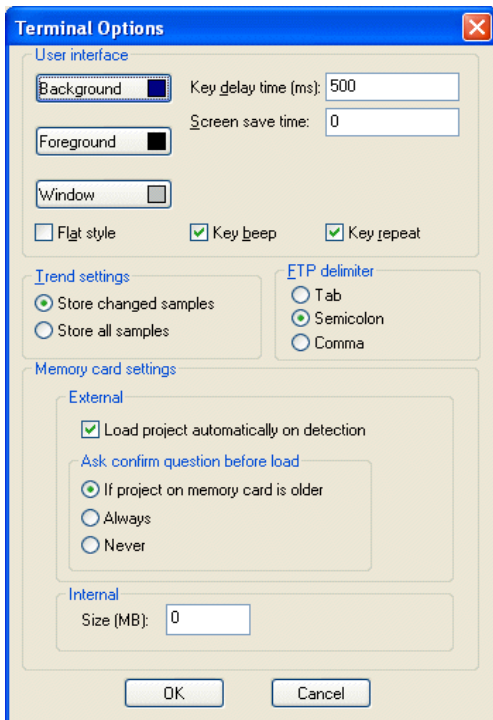

### Memory Card Settings

#### Ask confirm question before load

The question that will be displayed in the operator panel before loading the project.

#### If project on memory card is older

A question will be displayed if the date of the project is older than the existing project in the operator panel.

#### Always

A question will always be displayed when a project is detected on the external memory card.

#### Never

The project on the external memory card will automatically be loaded to the operator panel, without displaying a question.

## 24 Transfer of Controller Program and Parameters

It is possible to transfer MELSEC FX (serial) controller program and parameters to and from a USB Flash drive.

Other MELSEC drivers may also eventually support USB Flash drive transfer. Please see the driver documentation to verify this.

Controller independent functions are built into the E1000-series software. Controller specific functions can be found in the driver.

The USB memory stick must follow the standard for the USB mass storage device class, i.e if the USB stick is delivered with a CD that contains drivers it will most likely not work with the operator panels.

### 24.1 Transferring Controller Software to the USB Flash Drive (Upload)

The controller program can be transferred at operator panel startup. This is enabled by using the PLCU command, by selecting **Setup/System Signals** and typing the command on the **Commands** line.

A USB Flash drive has to be connected to the operator panel at startup.

At operator panel startup, the drivers in the operator panel are checked to verify if they support controller program upload/download. If so, and a USB Flash drive is connected, a dialog is displayed, letting the user start or skip an upload. In a second dialog, when having selected to start an upload, the user can enter the project name. If no choice is made in 10 seconds after display of the first dialog, the operator panel starts up without uploading controller software.

## 24.2 Transferring Controller Software from the USB Flash Drive (Download)

---

**Note:**

Only files that has been previously uploaded from the controller can be downloaded.

---

A USB Flash drive has to be connected to the operator panel at startup.

At operator panel startup, the drivers in the operator panel are checked to verify if they support controller program upload/download. If so, the files on the connected USB Flash drive are checked to verify if they have the same file extension as the drivers that support controller program upload/download in the operator panel. If so, a dialog is displayed, letting the user start or skip an download. In a second dialog, the user can select which project to download. If no choice is made in 10 seconds after display of the first dialog, the operator panel starts up without downloading controller software.



## 25 Updating the Operator Panel

In the operator panel, there is a system program (operating system), which is stored in the operator panel's memory on delivery.

The system program can be replaced, that is, updated to a newer version, either via PC or via external memory card. Not available for E1012 and E1022. See section [Downloading the System Program in E1012 and E1022](#) for these models.

---

**Note:**

When updating an operator panel, it is important to ensure that power is not interrupted during the transfer.

---

### 25.1 Downloading the System Program via PC

E-Designer 7 is used to download system programs via a PC to the operator panel. The transfer can be made via the serial port or over Ethernet. The serial cable should be a CAB30 cable and the Ethernet cable should be a crossed CAT5 cable.

Transferring the system program to the operator panel via a PC requires the following:

- PC with E-Designer 7 installed.
- Transfer cable between the PC and the operator panel.
- File with new system program (OPSys\_b\*.cab).

## Transfers Are Made in the Following Steps:

### By Serial Port

1. Connect the cable between the PC and the operator panel.
2. Open a project or create a new project with the desired operator panel type.
3. Select **Transfer/Update Operator Terminal System Program**.

No settings are required in the operator panel.

Under **Options/Communication Properties**, communication port and transfer speed are set.

### Over Ethernet

1. Connect the cable between the PC and operator panel.
2. Set the operator panel to **Service Menu mode**.
3. Enter a valid IP address for the operator panel.
4. Set the operator panel back to **Run-mode**.
5. Open a project or create a new project with the desired operator panel type.
6. Select **Transfer/Update Operator Terminal System Program**.
7. Select **Settings/Use TCP/IP transfer**.

For information about mode switches, see the Service and Maintenance manual for the E1000 operator panels (MA00758).

## 25.2 Downloading the System Program via External Memory Card

Transferring the system program to the operator panel via an external memory card requires the following:

- File with new system program (OPSys\_b\*.cab).
- Compact Flash memory card (only in E1070, E1100, E1071, E1101 and E1151) or USB Flash drive.

## Transfers Are Made in the Following Steps:

1. Save the system program file (OPSys\_b\*.cab) in the root of the external Compact Flash memory card or USB Flash drive.
2. Place the memory card in the operator panel, or connect the USB Flash drive, and start the operator panel to update the system program automatically.

## 25.3 Downloading the System Program in E1012 and E1022

An Image Loader is used to download system programs to the operator panel via a PC. The Image Loader is available from the website. The transfer is made via the serial port using a CAB30 cable.

Updating of the system program to the operator panel requires the following:

- PC with Image Loader application.
- CAB30 cable.

### Transfers Are Made in the Following Steps:

1. Run the Image Loader exe-file by double-clicking on it. Follow the instructions; also described in the following steps:
2. Connect the cable between the PC and the operator panel.
3. Disconnect the power to the operator panel.
4. Set the panel in Image Load mode by setting mode switch number 2 in the ON position according to the illustration below.

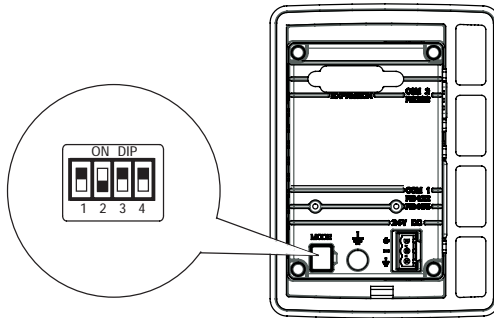

5. Reconnect power.
6. All operator panels connected to the COM-ports on the PC and currently set in Image Load mode will be available for selection from a drop down list. Select which operator panel to upgrade by selecting its MAC address (hex).
7. Click **Upgrade**.
8. When the upgrade is finished, disconnect power from the operator panel.
9. Change mode switch number 2 back in OFF position.

Reconnect power to the operator panel.