

CUT OUT

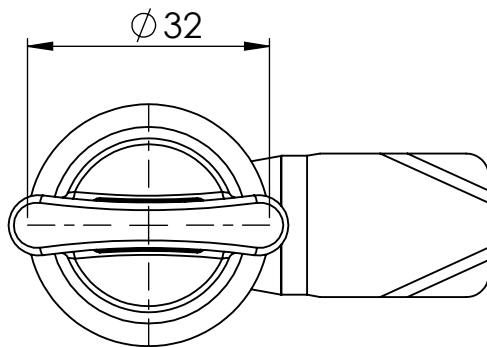
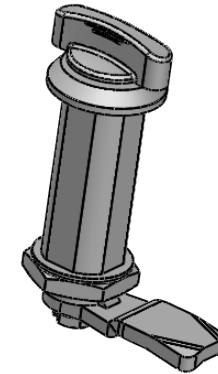

**NOTE**

1:2

**MATERIAL**

HOUSING: ZAMAK -ZNAL4CU1

KNOB : ZAMAK -ZNAL4CU1

CAM : STEEL

GASKET : RUBBER

**FINISH : CHROME PLATED**

IP 65

ACTION: LH/RH

**AWAITING APPROVAL**



© 2013 Essentra Components. All rights reserved.  
 Registered in England, Company No. 547495.  
 Registered Office: Avebury House,  
 201-249 Avebury Boulevard, Milton Keynes, MK9 1AU

Condition of Sale can be found on our website: [essentra.com](http://essentra.com).

Essentra Components does not warrant that the files will be error free and may create new versions ("Upgrades") at any time, which may correct such errors. Essentra Components has no obligation to notify you of such upgrades. Any upgraded file will be published to the website, when it becomes available.

You are not permitted to load any of the files on to a network server for the purposes of distribution to one or more other computer(s) on that network or to effect such distribution. Essentra Components shall not be liable for any loss or damage whatsoever or however caused, arising directly or indirectly from the use of the files.

**UNLESS OTHERWISE STATED**

ALL DIMENSIONS IN mm	DO NOT SCALE																																				
LINEAR TOLERANCE	THIRD ANGLE PROJECTION																																				
<table border="1"> <tr> <th>SIZE</th> <th>(0)</th> <th>(0.0)</th> <th>(0.00)</th> </tr> <tr> <td>0-10mm</td> <td>±0.5</td> <td>±0.15</td> <td>±0.10</td> </tr> <tr> <td>&gt;10-30</td> <td>±0.5</td> <td>±0.20</td> <td>±0.15</td> </tr> <tr> <td>&gt;30-50</td> <td>±0.5</td> <td>±0.30</td> <td>±0.20</td> </tr> <tr> <td>&gt;50-100</td> <td>±0.8</td> <td>±0.50</td> <td>±0.25</td> </tr> <tr> <td>&gt;100-200</td> <td>±1.5</td> <td>±0.80</td> <td>±0.40</td> </tr> <tr> <td>&gt;200-300</td> <td>±2.0</td> <td>±1.20</td> <td>±0.80</td> </tr> <tr> <td>&gt;300-500</td> <td>±3.0</td> <td>±2.00</td> <td>±1.00</td> </tr> <tr> <td>&gt;500</td> <td>±5.0</td> <td>±3.00</td> <td>±1.50</td> </tr> </table>	SIZE	(0)	(0.0)	(0.00)	0-10mm	±0.5	±0.15	±0.10	>10-30	±0.5	±0.20	±0.15	>30-50	±0.5	±0.30	±0.20	>50-100	±0.8	±0.50	±0.25	>100-200	±1.5	±0.80	±0.40	>200-300	±2.0	±1.20	±0.80	>300-500	±3.0	±2.00	±1.00	>500	±5.0	±3.00	±1.50	
SIZE	(0)	(0.0)	(0.00)																																		
0-10mm	±0.5	±0.15	±0.10																																		
>10-30	±0.5	±0.20	±0.15																																		
>30-50	±0.5	±0.30	±0.20																																		
>50-100	±0.8	±0.50	±0.25																																		
>100-200	±1.5	±0.80	±0.40																																		
>200-300	±2.0	±1.20	±0.80																																		
>300-500	±3.0	±2.00	±1.00																																		
>500	±5.0	±3.00	±1.50																																		
ANGULAR TOLERANCE ±0.5 DEGREES UNSPECIFIED RADII 0.25mm DRAFT ANGLE 0.5 DEGREES DIMENSIONS IN BRACKETS [ ] ARE IN INCHES FOR REFERENCE ONLY																																					

ORG. SCALE: 1:1      CREATE DATE: 16/10/2018

MATERIAL: SEE NOTES

Part ID: 1078951      Project: P020266-1

TITLE: QRTN WING KNOB GRPR 58MM

DWG. No. 064362501137E      SHEET 1 of 1  
 ISSUE 1